

# **GSM and EDGE Guide**

## **Agilent Technologies PSA Series and VSA E4406A**

**Options 202, 252, BAH**

**This manual provides documentation for the following instruments:**

**Transmitter Tester:**

**E4406A**

**Spectrum Analyzers:**

**E4440A (3 Hz – 26.5 GHz)**

**E4443A (3 Hz – 6.7 GHz)**

**E4445A (3 Hz – 13.2 GHz)**

**E4446A (3 Hz – 44.0 GHz)**

**E4448A (3 Hz – 50.0 GHz)**



**Agilent Technologies**

**Manufacturing Part Number: E4406-90276**

**Supersedes E4406-90254**

**Printed in Malaysia**

**November 2004**

© Copyright 1999 - 2004 Agilent Technologies, Inc.

The information contained in this document is subject to change without notice.

Agilent Technologies makes no warranty of any kind with regard to this material, including but not limited to, the implied warranties of merchantability and fitness for a particular purpose. Agilent Technologies shall not be liable for errors contained herein or for incidental or consequential damages in connection with the furnishing, performance, or use of this material.

<b>1. Introduction to GSM and EDGE</b>	
What Do the Agilent PSA Series Option 202 and VSA E4406A Option BAH do? . . . . .	34
Installing Optional Measurement Personalities . . . . .	35
Do You Have Enough Memory to Load All Your Personality Options? . . . . .	35
How to Predict Your Memory Requirements . . . . .	37
Loading an Optional Measurement Personality . . . . .	39
Obtaining and Installing a License Key . . . . .	39
Viewing a License Key . . . . .	41
Using the Delete License Key (PSA Only) . . . . .	41
Using the Uninstall Key (E4406A Only) . . . . .	42
Performing a Security Erase on PSA Series Spectrum Analyzers . . . . .	42
Ordering Optional Measurement Personalities . . . . .	43
<b>2. Making Measurements</b>	
GSM and EDGE Measurements . . . . .	46
Setting up and Making a Measurement . . . . .	48
Making the Initial Signal Connection . . . . .	48
Using Instrument Mode and Measurement Presets . . . . .	48
The 3 Steps to Set Up and Make Measurements . . . . .	49
EDGE Power vs. Time (PVT) Measurements . . . . .	50
Configuring the Measurement System . . . . .	50
Setting the MS (Example) . . . . .	51
Measurement Procedure . . . . .	51
Results . . . . .	52
Troubleshooting Hints . . . . .	55
EDGE Error Vector Magnitude (EVM) Measurements . . . . .	56
Configuring the Measurement System . . . . .	56
Setting the MS (Example) . . . . .	57
Measurement Procedure . . . . .	57
Results . . . . .	58
Troubleshooting Hints . . . . .	59
EDGE Output RF Spectrum (ORFS) Measurements . . . . .	60
Configuring the Measurement System . . . . .	60
Setting the MS (Example) . . . . .	61
Measurement Procedure . . . . .	61
EDGE ORFS Measurement Results . . . . .	63
EDGE Tx Band Spur Measurements . . . . .	72
Configuring the Measurement System . . . . .	72
Setting the MS (Example) . . . . .	73
Measurement Procedure . . . . .	73
Results . . . . .	74
Troubleshooting Hints . . . . .	74
GMSK Output RF Spectrum (ORFS) Measurements . . . . .	75
Configuring the Measurement System . . . . .	75
Setting the MS (Example) . . . . .	76
Measurement Procedure . . . . .	76
GMSK ORFS Measurement Results . . . . .	78
GMSK Phase and Frequency Error Measurements . . . . .	87
Configuring the Measurement System . . . . .	87

---

# Contents

Setting the MS (Example) . . . . .	.88
Measurement Procedure . . . . .	.88
Results . . . . .	.89
Troubleshooting Hints . . . . .	.91
GMSK Power vs. Time (PvT) Measurements . . . . .	.92
Configuring the Measurement System . . . . .	.92
Setting the MS (Example) . . . . .	.93
Measurement Procedure . . . . .	.93
Results . . . . .	.94
Troubleshooting Hints . . . . .	.98
GMSK Transmitter Band Spurious Signal (Tx Band Spur) Measurements . . . . .	.99
Configuring the Measurement System . . . . .	.99
Setting the MS (Example) . . . . .	100
Measurement Procedure . . . . .	100
Results . . . . .	101
Troubleshooting Hints . . . . .	101
Spectrum (Frequency Domain) Measurements . . . . .	102
Configuring the Measurement System . . . . .	102
Setting the MS . . . . .	103
Measurement Procedure . . . . .	103
Transmit Power Measurements . . . . .	113
Configuring the Measurement System . . . . .	113
Setting the MS (Example) . . . . .	114
Measurement Procedure . . . . .	114
Troubleshooting Hints . . . . .	116
Waveform (Time Domain) Measurements . . . . .	117
Configuring the Measurement System . . . . .	117
Setting the MS . . . . .	118
Measurement Procedure . . . . .	118
Using Option B7C Baseband I/Q Inputs . . . . .	127
Baseband I/Q Measurements Available for E4406A VSA Series Transmitter Tester . . . . .	127
Baseband I/Q Measurement Overview . . . . .	128
Baseband I/Q Measurement Result Examples . . . . .	129
Using Basic Mode . . . . .	132
Basic Mode in E4406A VSA Series Transmitter Testers . . . . .	132
Basic Mode in PSA Series Spectrum Analyzers . . . . .	132
Interpreting Error Codes . . . . .	133
<b>3. Key Reference</b>	
Instrument Front Panel Highlights . . . . .	136
Front Panel Keys . . . . .	139
FREQUENCY Channel Key Menu . . . . .	139
Measurement Control Key Menu . . . . .	142
MODE Key Menu . . . . .	142
Mode Setup Key Menu . . . . .	143
Input/Output Key Menu . . . . .	148
Measurement Keys . . . . .	152
EDGE EVM (Error Vector Magnitude)	
Measurement Keys . . . . .	152

EDGE Output RF Spectrum Measurement Keys . . . . .	162
EDGE Power vs. Time Measurement Keys . . . . .	173
EDGE Tx Band Spur Measurement Keys . . . . .	181
GMSK Output RF Spectrum Measurement Keys . . . . .	184
GMSK Phase and Frequency Error Measurement Keys . . . . .	195
GMSK Power vs. Time Measurement Keys . . . . .	201
GMSK Tx Band Spur Measurement Keys . . . . .	211
Spectrum (Frequency Domain) Keys . . . . .	214
Transmit Power Measurement Keys . . . . .	228
Waveform (Time Domain) Keys . . . . .	233
Baseband I/Q Inputs (Option B7C ) Keys . . . . .	247
Input Port Key Menu . . . . .	247
I/Q Setup Key Menu . . . . .	248
I/Q Range Key Menu . . . . .	250
Baseband I/Q Key Access Locations . . . . .	251
<b>4. Programming Commands</b>	
SCPI Command Subsystems . . . . .	254
Programming Command Compatibility	
Across Model Numbers and Across Modes . . . . .	255
Across PSA Modes: Command Subsystem Similarities . . . . .	255
Across PSA Modes: Specific Command Differences . . . . .	257
Using Applications in PSA Series vs. VSA E4406A . . . . .	258
CALCulate Subsystem . . . . .	260
Test Current Results Against all Limits . . . . .	261
Data Query . . . . .	262
Calculate/Compress Trace Data Query . . . . .	263
Calculate Peaks of Trace Data . . . . .	272
CALCulate EDGE EVM Subsystem . . . . .	274
EDGE TX Band Spur Calculate Commands . . . . .	290
CALCulate:MARKers Subsystem . . . . .	291
CALCulate Phase and Frequency Error Subsystem . . . . .	303
Baseband I/Q - Spectrum I/Q Marker Query . . . . .	308
Transmit Band Spurious - Limits . . . . .	309
Baseband I/Q - Waveform I/Q Marker Query . . . . .	310
CONFigure Subsystem . . . . .	311
Configure the Selected Measurement . . . . .	311
Configure Query . . . . .	311
DISPlay Subsystem . . . . .	312
Adjacent Channel Power - View Selection . . . . .	312
Turn the Display On/Off . . . . .	312
EDGE PVT - Limit Mask On/Off . . . . .	313
Select Display Format . . . . .	313
Select Display Format . . . . .	313
Full Screen Display (PSA Only) . . . . .	314
PVT - Limit Mask Display . . . . .	314
Spectrum - Y-Axis Scale/Div . . . . .	315
Spectrum - Y-Axis Reference Level . . . . .	316
Turn a Trace Display On/Off . . . . .	317

---

# Contents

Waveform - Y-Axis Scale/Div . . . . .	321
Waveform - Y-Axis Reference Level . . . . .	322
FETCh Subsystem . . . . .	324
Fetch the Current Measurement Results . . . . .	324
FORMat Subsystem . . . . .	325
Byte Order . . . . .	325
Numeric Data Format . . . . .	325
INITiate Subsystem . . . . .	327
Take New Data Acquisition for Selected Measurement . . . . .	327
Continuous or Single Measurements . . . . .	327
Take New Data Acquisitions . . . . .	328
Restart the Measurement . . . . .	328
INSTrument Subsystem . . . . .	329
Catalog Query . . . . .	329
Select Application by Number . . . . .	329
Select Application . . . . .	330
MEASure Group of Commands . . . . .	332
Command Interactions: MEASure, CONFIgure, FETCh, INITiate and READ . . . . .	333
50 MHz Amplitude Reference Measurement . . . . .	337
EDGE Error Vector Magnitude Measurement . . . . .	338
EDGE Output RF Spectrum Measurement . . . . .	341
EDGE Power vs. Time Measurement . . . . .	345
EDGE Transmit Band Spurs Measure Commands . . . . .	348
GMSK Output RF Spectrum Measurement . . . . .	350
GMSK Phase & Frequency Error Measurement . . . . .	354
GMSK Power vs. Time Measurement . . . . .	357
Sensor Measurement . . . . .	361
Spectrum (Frequency Domain) Measurement . . . . .	362
Timebase Frequency Measurement . . . . .	365
GMSK Transmit Band Spurs Measurement . . . . .	366
GMSK Transmit Power Measurement . . . . .	367
Waveform (Time Domain) Measurement . . . . .	369
READ Subsystem . . . . .	371
Initiate and Read Measurement Data . . . . .	371
SENSE Subsystem . . . . .	372
Baseband I/Q Commands (E4406A only) . . . . .	372
Channel Commands . . . . .	374
Signal Corrections Commands . . . . .	379
EDGE Error Vector Magnitude Measurement . . . . .	380
EDGE Output RF Spectrum Measurement . . . . .	385
EDGE Power vs. Time (Burst Power) Measurement . . . . .	403
EDGE Transmit Band Spurs Measurement . . . . .	418
RF Input Signal Alignments . . . . .	420
Frequency Commands . . . . .	422
GMSK Output RF Spectrum Measurement . . . . .	423
GMSK Phase & Frequency Error Measurement . . . . .	439
Select I/Q Power Range (E4406A only) . . . . .	443
Select I/Q Voltage Range (E4406A only) . . . . .	443
RF Power Commands . . . . .	444

GMSK Power vs. Time Measurement . . . . .	447
Radio Standards Commands . . . . .	463
Reference Oscillator Commands . . . . .	468
Spectrum (Frequency-Domain) Measurement . . . . .	471
Synchronization Commands . . . . .	486
GMSK Transmit Band Spurs Measurement . . . . .	487
Transmit Power Measurement . . . . .	490
Waveform (Time-Domain) Measurement . . . . .	494
TRIGger Subsystem . . . . .	502
Automatic Trigger Control . . . . .	502
Automatic Trigger Time . . . . .	502
External Trigger Delay . . . . .	503
External Trigger Level . . . . .	503
External Trigger Slope . . . . .	503
Frame Trigger Adjust . . . . .	504
Frame Trigger Period . . . . .	504
Frame Trigger Sync Source . . . . .	505
Frame Trigger Synchronization Offset . . . . .	505
Trigger Holdoff . . . . .	506
Video (IF) Trigger Delay . . . . .	506
Video (IF) Trigger Level . . . . .	506
Video (IF) Trigger Slope . . . . .	507
RF Burst Trigger Delay . . . . .	507
RF Burst Trigger Level . . . . .	507
RF Burst Trigger Slope . . . . .	508

**5. Concepts**

What are GSM and EDGE? . . . . .	510
Frequently Used Terms . . . . .	513
Mobile Stations and Base Transceiver Stations . . . . .	513
Uplink and Downlink . . . . .	513
ARFCN. . . . .	513
Timeslots . . . . .	513
Transmit Power Measurement Concepts . . . . .	514
Purpose . . . . .	514
Measurement Method. . . . .	514
GMSK Power vs. Time Measurement Concepts . . . . .	515
Purpose . . . . .	515
Measurement Method. . . . .	515
Measurement Adjustments . . . . .	516
Measurement Results. . . . .	519
GMSK Phase and Frequency Error Measurement Concepts . . . . .	521
Purpose . . . . .	521
Measurement Method. . . . .	521
Measurement Adjustments . . . . .	521
GMSK Output RF Spectrum Measurement Concepts . . . . .	524
Purpose . . . . .	524
Measurement Method. . . . .	524
Changing the View . . . . .	527

---

# Contents

GMSK Tx Band Spur Measurement Concepts .....	.528
Purpose .....	.528
Measurement Method .....	.528
Changing the View .....	.529
EDGE Power vs. Time Measurement Concepts .....	.530
Purpose .....	.530
Measurement Method .....	.530
Measurement Adjustments .....	.531
EDGE EVM Measurement Concepts .....	.532
Purpose .....	.532
Measurement Method .....	.532
Measurement Adjustments .....	.532
EDGE Output RF Spectrum Measurement Concepts .....	.537
Purpose .....	.537
Measurement Method .....	.537
Measurement Adjustments .....	.541
EDGE Tx Band Spur Measurement Concepts .....	.542
Purpose .....	.542
Measurement Method .....	.542
Measurement Adjustments .....	.543
Spectrum (Frequency Domain) Measurement Concepts .....	.544
Purpose .....	.544
Measurement Method .....	.544
Troubleshooting Hints .....	.544
Waveform (Time Domain) Measurement Concepts .....	.545
Purpose .....	.545
Measurement Method .....	.545
Baseband I/Q Inputs (Option B7C ) Measurement Concepts .....	.546
What are Baseband I/Q Inputs? .....	.546
What are Baseband I/Q Signals? .....	.547
Why Make Measurements at Baseband? .....	.547
Selecting Input Probes for Baseband Measurements .....	.547
Baseband I/Q Measurement Views .....	.550
Other Sources of Measurement Information .....	.553
Instrument Updates at <a href="http://www.agilent.com">www.agilent.com</a> .....	.553
<b>6. Menu Maps</b>	
EDGE and GSM Measurement Key Flow .....	.556



---

## List of Commands

:CALCulate:CLIMits:FAIL? .....	261
:CALCulate:DATA<n>:COMPRESS? BLOCK   CFIT   MAXimum   MINimum   MEAN   DMEan   RMS   SAMPLe   SDEViation [,<soffset>[,<length>[,<roffset>[,<rlimit>]]]] .....	263
:CALCulate:DATA<n>:PEAKs? <threshold>,<excursion>[,AMPLitude   FREQuency   TIME] ...	272
:CALCulate:DATA[n]? .....	262
:CALCulate:EEVM:LIMit:BTS:EXTRemE:EVMP95 <real>.....	274
:CALCulate:EEVM:LIMit:BTS:EXTRemE:EVMP95? .....	274
:CALCulate:EEVM:LIMit:BTS:EXTRemE:FERRor <real> .....	274
:CALCulate:EEVM:LIMit:BTS:EXTRemE:FERRor? .....	274
:CALCulate:EEVM:LIMit:BTS:EXTRemE:IQOOffset <float> .....	275
:CALCulate:EEVM:LIMit:BTS:EXTRemE:IQOOffset? .....	275
:CALCulate:EEVM:LIMit:BTS:EXTRemE:PEVM <real>.....	276
:CALCulate:EEVM:LIMit:BTS:EXTRemE:PEVM? .....	276
:CALCulate:EEVM:LIMit:BTS:EXTRemE:REVM <real> .....	277
:CALCulate:EEVM:LIMit:BTS:EXTRemE:REVM? .....	277
:CALCulate:EEVM:LIMit:BTS:NORMal:EVMP95 <real>.....	277
:CALCulate:EEVM:LIMit:BTS:NORMal:EVMP95? .....	278
:CALCulate:EEVM:LIMit:BTS:NORMal:FERRor <real> .....	278
:CALCulate:EEVM:LIMit:BTS:NORMal:FERRor? .....	278
:CALCulate:EEVM:LIMit:BTS:NORMal:IQOOffset <float> .....	279
:CALCulate:EEVM:LIMit:BTS:NORMal:IQOOffset? .....	279
:CALCulate:EEVM:LIMit:BTS:NORMal:PEVM <real>.....	280
:CALCulate:EEVM:LIMit:BTS:NORMal:PEVM? .....	280
:CALCulate:EEVM:LIMit:BTS:NORMal:REVM <real>.....	280
:CALCulate:EEVM:LIMit:BTS:NORMal:REVM? .....	280
:CALCulate:EEVM:LIMit:MBTS:EXTRemE:FERRor <real>.....	282
:CALCulate:EEVM:LIMit:MBTS:EXTRemE:FERRor? .....	282
:CALCulate:EEVM:LIMit:MBTS:NORMal:FERRor <real>.....	283
:CALCulate:EEVM:LIMit:MBTS:NORMal:FERRor? .....	283
:CALCulate:EEVM:LIMit:MS:EXTRemE:EVMP95 <real> .....	281
:CALCulate:EEVM:LIMit:MS:EXTRemE:EVMP95? .....	281

---

# List of Commands

:CALCulate:EEVM:LIMit:MS:EXTReme:FERRor <real>	.282
:CALCulate:EEVM:LIMit:MS:EXTReme:FERRor?	.282
:CALCulate:EEVM:LIMit:MS:EXTReme:IQOOffset <real>	.283
:CALCulate:EEVM:LIMit:MS:EXTReme:IQOOffset?	.283
:CALCulate:EEVM:LIMit:MS:EXTReme:PEVM <real>	.284
:CALCulate:EEVM:LIMit:MS:EXTReme:PEVM?	.284
:CALCulate:EEVM:LIMit:MS:EXTReme:REVM <real>	.285
:CALCulate:EEVM:LIMit:MS:EXTReme:REVM?	.285
:CALCulate:EEVM:LIMit:MS:NORMal:EVMP95 <real>	.285
:CALCulate:EEVM:LIMit:MS:NORMal:EVMP95?	.285
:CALCulate:EEVM:LIMit:MS:NORMal:FERRor <real>	.286
:CALCulate:EEVM:LIMit:MS:NORMal:FERRor?	.286
:CALCulate:EEVM:LIMit:MS:NORMal:IQOOffset <real>	.286
:CALCulate:EEVM:LIMit:MS:NORMal:IQOOffset?	.286
:CALCulate:EEVM:LIMit:MS:NORMal:PEVM <real>	.287
:CALCulate:EEVM:LIMit:MS:NORMal:PEVM?	.287
:CALCulate:EEVM:LIMit:MS:NORMal:REVM <real>	.287
:CALCulate:EEVM:LIMit:MS:NORMal:REVM?	.287
:CALCulate:EEVM:LIMit:PBTS:EXTReme:FERRor <real>	.288
:CALCulate:EEVM:LIMit:PBTS:EXTReme:FERRor?	.288
:CALCulate:EEVM:LIMit:PBTS:NORMal:FERRor <real>	.289
:CALCulate:EEVM:LIMit:PBTS:NORMal:FERRor?	.289
:CALCulate:ETSPur:LIMit:TEST ABSolute   RELative	.290
:CALCulate:ETSPur:LIMit:TEST?	.290
:CALCulate:ETSPur:LIMit[:UPPer][:DATA] <power>	.290
:CALCulate:ETSPur:LIMit[:UPPer][:DATA]?	.290
:CALCulate:PFER:LIMit:BTS:FERRor <real>	.303
:CALCulate:PFER:LIMit:BTS:FERRor?	.303
:CALCulate:PFER:LIMit:BTS:PPHase <degree>	.303
:CALCulate:PFER:LIMit:BTS:PPHase?	.303
:CALCulate:PFER:LIMit:BTS:RPHase <degree>	.304

---

# List of Commands

:CALCulate:PFER:LIMit:BTS:RPHase? . . . . .	304
:CALCulate:PFER:LIMit:MBTS:FERRor <real> . . . . .	304
:CALCulate:PFER:LIMit:MBTS:FERRor? . . . . .	304
:CALCulate:PFER:LIMit:MS:FERRor <real>. . . . .	305
:CALCulate:PFER:LIMit:MS:FERRor? . . . . .	305
:CALCulate:PFER:LIMit:MS:PPHase <degree>. . . . .	305
:CALCulate:PFER:LIMit:MS:PPHase? . . . . .	305
:CALCulate:PFER:LIMit:MS:RPHase <degree> . . . . .	306
:CALCulate:PFER:LIMit:MS:RPHase? . . . . .	306
:CALCulate:PFER:LIMit:PBTS:FERRor <real>. . . . .	307
:CALCulate:PFER:LIMit:PBTS:FERRor? . . . . .	307
:CALCulate:SPECTrum:MARKer[1]   2   3   4:IQ? . . . . .	308
:CALCulate:TSPur:LIMit:TEST ABSolute   RELative . . . . .	309
:CALCulate:TSPur:LIMit:TEST? . . . . .	309
:CALCulate:TSPur:LIMit[:UPPer][:DATA] <power> . . . . .	309
:CALCulate:TSPur:LIMit[:UPPer][:DATA]? . . . . .	309
:CALCulate:WAVEform:MARKer[1]   2   3   4:IQ? . . . . .	310
:CALCulate:<measurement>:MARKer:AOFF . . . . .	294
:CALCulate:<measurement>:MARKer[1]   2   3   4:FUNCtion:RESult? . . . . .	294
:CALCulate:<measurement>:MARKer[1]   2   3   4:MAXimum . . . . .	294
:CALCulate:<measurement>:MARKer[1]   2   3   4:MINimum . . . . .	295
:CALCulate:<measurement>:MARKer[1]   2   3   4:MODE POSition   DELTa . . . . .	295
:CALCulate:<measurement>:MARKer[1]   2   3   4:MODE POSition   DELTa   RMSDegree   RMSRadian   RFM   RMSJitter   OFF . . . . .	295
:CALCulate:<measurement>:MARKer[1]   2   3   4:MODE?. . . . .	295
:CALCulate:<measurement>:MARKer[1]   2   3   4:TRACe <trace_name>. . . . .	296
:CALCulate:<measurement>:MARKer[1]   2   3   4:TRACe? . . . . .	296
:CALCulate:<measurement>:MARKer[1]   2   3   4:X <param>. . . . .	300
:CALCulate:<measurement>:MARKer[1]   2   3   4:X:POSition <integer> . . . . .	301
:CALCulate:<measurement>:MARKer[1]   2   3   4:X:POSition? . . . . .	301
:CALCulate:<measurement>:MARKer[1]   2   3   4:X? . . . . .	300

---

# List of Commands

:CALCulate:<measurement>:MARKer[1]   2   3   4:Y? . . . . .	.301
:CALCulate:<measurement>:MARKer[1]   2   3   4[:STATe] OFF   ON   0   1 . . . . .	.296
:CALCulate:<measurement>:MARKer[1]   2   3   4[:STATe]? . . . . .	.296
:CONFigure:AREFERENCE . . . . .	.337
:CONFigure:EEVM . . . . .	.338
:CONFigure:EORFSpectr . . . . .	.341
:CONFigure:EPVTime . . . . .	.345
:CONFigure:ETSPur . . . . .	.348
:CONFigure:ORFSpectrum . . . . .	.350
:CONFigure:PFERror . . . . .	.354
:CONFigure:PVTime . . . . .	.357
:CONFigure:SENSors . . . . .	.361
:CONFigure:SPECTrum . . . . .	.362
:CONFigure:TBFrequency . . . . .	.365
:CONFigure:TSPur . . . . .	.366
:CONFigure:TXPower . . . . .	.367
:CONFigure:WAVEform . . . . .	.369
:CONFigure:<measurement> . . . . .	.311
:CONFigure? . . . . .	.311
:DISPlay:ACP:VIEW BGRaph   SPECTrum . . . . .	.312
:DISPlay:ACP:VIEW? . . . . .	.312
:DISPlay:ENABLE OFF   ON   0   1 . . . . .	.312
:DISPlay:ENABLE? . . . . .	.312
:DISPlay:EPVTime:LIMit:MASK OFF   ON   0   1 . . . . .	.313
:DISPlay:EPVTime:LIMit:MASK? . . . . .	.313
:DISPlay:FORMat:TILE . . . . .	.313
:DISPlay:FORMat:ZOOM . . . . .	.313
:DISPlay:FSCREEN[:STATe] OFF   ON   0   1 . . . . .	.314
:DISPlay:FSCREEN[:STATe]? . . . . .	.314
:DISPlay:FSCREEN   FULLSCREEN[:STATe] ON   OFF   1   0 . . . . .	.314
:DISPlay:FSCREEN   FULLSCREEN[:STATe]? . . . . .	.314

---

## List of Commands

:DISPlay:PVTIme:LIMit:MASK OFF   ON   0   1	314
:DISPlay:PVTIme:LIMit:MASK?	314
:DISPlay:SPECtrum[n]:WINDow[m]:TRACe:Y[:SCALe]:PDIVision <power>	315
:DISPlay:SPECtrum[n]:WINDow[m]:TRACe:Y[:SCALe]:PDIVision?	315
:DISPlay:SPECtrum[n]:WINDow[m]:TRACe:Y[:SCALe]:RLEVel <power>	316
:DISPlay:SPECtrum[n]:WINDow[m]:TRACe:Y[:SCALe]:RLEVel?	316
:DISPlay:TRACe[n][:STATe] OFF   ON   0   1	317
:DISPlay:TRACe[n][:STATe]?	317
:DISPlay:WAVEform[n]:WINDow[m]:TRACe:Y[:SCALe]:PDIVision <power>	321
:DISPlay:WAVEform[n]:WINDow[m]:TRACe:Y[:SCALe]:PDIVision?	321
:DISPlay:WAVEform[n]:WINDow[m]:TRACe:Y[:SCALe]:RLEVel <power>	322
:DISPlay:WAVEform[n]:WINDow[m]:TRACe:Y[:SCALe]:RLEVel?	322
:FETCh:AREFERENCE[n]?	337
:FETCh:EEVM[n]?	338
:FETCh:EORFspectr[n]?	341
:FETCh:EPVTime[n]?	345
:FETCh:ETSPur[n]?	348
:FETCh:ORFspectrum[n]?	350
:FETCh:PFERror[n]?	354
:FETCh:PVTIme[n]?	357
:FETCh:SENSors[n]?	361
:FETCh:SPECtrum[n]?	362
:FETCh:TBFRequency[n]?	365
:FETCh:TSPur[n]?	366
:FETCh:TXPower[n]?	367
:FETCh:WAVEform[n]?	369
:FETCh:<measurement>[n]?	324
:FORMat:BORDER NORMAl   SWAPped	325
:FORMat:BORDER?	325
:FORMat[:DATA] ASCii   REAL,32   REAL,64	325
:FORMat[:DATA]?	325

---

# List of Commands

:FORMat[:TRACe][:DATA] ASCii   INTeger,16   INTeger,32   REAL,32   REAL,64   UINTeGer,16	.325
:FORMat[:TRACe][:DATA] ASCii   REAL[,32]	.325
:FORMat[:TRACe][:DATA]?	.325
:FORMat[:TRACe][:DATA]?	.325
:INITiate:AREFERENCE	.337
:INITiate:CONTinuous OFF   ON   0   1	.327
:INITiate:CONTinuous?	.327
:INITiate:EEVM	.338
:INITiate:EORFspectr	.341
:INITiate:EPVTime	.345
:INITiate:ETSPur	.348
:INITiate:ORFSpectrum	.350
:INITiate:PFERror?	.354
:INITiate:PVTime	.357
:INITiate:REStart	.328
:INITiate:SENSors	.361
:INITiate:SPECTrum	.362
:INITiate:TBFRequency	.365
:INITiate:TSPur	.366
:INITiate:TXPower	.367
:INITiate:WAVeform	.369
:INITiate:<measurement>	.327
:INITiate[:IMMEDIATE]	.328
:INSTrument:CATalog?	.329
:INSTrument:CATalog[:FULL]?	.329
:INSTrument:NSElect <integer>	.329
:INSTrument:NSElect?	.329
:INSTrument[:SElect] BASIC   SERVICE   CDMA   CDMA2K   GSM   EDGEgSM   IDEN   NADC   PDC   WCDMA   CDMA1XEV	.330
:INSTrument[:SElect] SA   PNOISE   BASIC   CDMA   CDMA2K   EDGEgSM   NADC   PDC   WCDMA   CDMA1XEV   NFIGURE	.330
:INSTrument[:SElect]?	.330

---

# List of Commands

:MEASure:AREFERENCE[n]?	337
:MEASure:EEVM[n]?	338
:MEASure:EORFspectr[n]?	341
:MEASure:EPVTime[n]?	345
:MEASure:ETSPur[n]?	348
:MEASure:ORFSpectrum[n]?	350
:MEASure:PFERror[n]?	354
:MEASure:PVTime[n]?	357
:MEASure:SENSors[n]?	361
:MEASure:SPECTrum[n]?	362
:MEASure:TBFRequency[n]?	365
:MEASure:TSPur[n]?	366
:MEASure:TXPower[n]?	367
:MEASure:WAVEform[n]?	369
:READ:AREFERENCE[n]?	337
:READ:EEVM[n]?	338
:READ:EORFspectr[n]?	341
:READ:EPVTime[n]?	345
:READ:ETSPur[n]?	348
:READ:ORFSpectrum[n]?	350
:READ:PFERror[n]?	354
:READ:PVTime[n]?	357
:READ:SENSors[n]?	361
:READ:SPECTrum[n]?	362
:READ:TBFRequency[n]?	365
:READ:TSPur[n]?	366
:READ:TXPower[n]?	367
:READ:WAVEform[n]?	369
:READ:<measurement>[n]?	371
:TRIGger[:SEQuence]:AUTO:STATe OFF   ON   0   1	502
:TRIGger[:SEQuence]:AUTO:STATe?	502

---

# List of Commands

:TRIGger[:SEQuence]:AUTO[:TIME] <time> . . . . .	502
:TRIGger[:SEQuence]:AUTO[:TIME]? . . . . .	502
:TRIGger[:SEQuence]:EXTErnal[1]   2:DELAy <time> . . . . .	503
:TRIGger[:SEQuence]:EXTErnal[1]   2:DELAy? . . . . .	503
:TRIGger[:SEQuence]:EXTErnal[1]   2:LEVEl <voltage> . . . . .	503
:TRIGger[:SEQuence]:EXTErnal[1]   2:LEVEl? . . . . .	503
:TRIGger[:SEQuence]:EXTErnal[1]   2:SLOPe NEGative   POSitive . . . . .	503
:TRIGger[:SEQuence]:EXTErnal[1]   2:SLOPe? . . . . .	504
:TRIGger[:SEQuence]:FRAMe:ADJust <time> . . . . .	504
:TRIGger[:SEQuence]:FRAMe:PERiod <time> . . . . .	504
:TRIGger[:SEQuence]:FRAMe:PERiod? . . . . .	504
:TRIGger[:SEQuence]:FRAMe:SYNC EXTFRont   EXTREar   OFF . . . . .	505
:TRIGger[:SEQuence]:FRAMe:SYNC:OFFSet <time> . . . . .	505
:TRIGger[:SEQuence]:FRAMe:SYNC:OFFSet? . . . . .	505
:TRIGger[:SEQuence]:FRAMe:SYNC? . . . . .	505
:TRIGger[:SEQuence]:HOLDoff <time> . . . . .	506
:TRIGger[:SEQuence]:HOLDoff? . . . . .	506
:TRIGger[:SEQuence]:IF:DELAy <time> . . . . .	506
:TRIGger[:SEQuence]:IF:DELAy? . . . . .	506
:TRIGger[:SEQuence]:IF:LEVEl <ampl> . . . . .	506
:TRIGger[:SEQuence]:IF:LEVEl? . . . . .	506
:TRIGger[:SEQuence]:IF:SLOPe NEGative   POSitive . . . . .	507
:TRIGger[:SEQuence]:IF:SLOPe? . . . . .	507
:TRIGger[:SEQuence]:RFBurst:DELAy <time> . . . . .	507
:TRIGger[:SEQuence]:RFBurst:DELAy? . . . . .	507
:TRIGger[:SEQuence]:RFBurst:LEVEl <rel_power> . . . . .	507
:TRIGger[:SEQuence]:RFBurst:LEVEl? . . . . .	507
:TRIGger[:SEQuence]:RFBurst:SLOPe NEGative   POSitive . . . . .	508
:TRIGger[:SEQuence]:RFBurst:SLOPe? . . . . .	508
[:SENSe]:CHANnel:ARFCn   RFCHannel <integer> . . . . .	374
[:SENSe]:CHANnel:ARFCn   RFCHannel:BOTTom . . . . .	374



---

## List of Commands

[:SENSe]:CHANnel:ARFCn   RFCHannel:MIDDLE . . . . .	375
[:SENSe]:CHANnel:ARFCn   RFCHannel:TOP . . . . .	376
[:SENSe]:CHANnel:ARFCn   RFCHannel? . . . . .	374
[:SENSe]:CHANnel:BURSt NORMal   SYNC   ACCess . . . . .	376
[:SENSe]:CHANnel:BURSt? . . . . .	376
[:SENSe]:CHANnel:SLOT <integer> . . . . .	377
[:SENSe]:CHANnel:SLOT:AUTO OFF   ON   0   1 . . . . .	377
[:SENSe]:CHANnel:SLOT:AUTO? . . . . .	377
[:SENSe]:CHANnel:SLOT? . . . . .	377
[:SENSe]:CHANnel:TSCode <integer> . . . . .	378
[:SENSe]:CHANnel:TSCode:AUTO OFF   ON   0   1 . . . . .	378
[:SENSe]:CHANnel:TSCode:AUTO? . . . . .	378
[:SENSe]:CHANnel:TSCode? . . . . .	378
[:SENSe]:CORRection:BTS[:RF]:LOSS <rel_power> . . . . .	379
[:SENSe]:CORRection:BTS[:RF]:LOSS? . . . . .	379
[:SENSe]:CORRection:MS[:RF]:LOSS <rel_power> . . . . .	379
[:SENSe]:CORRection:MS[:RF]:LOSS? . . . . .	379
[:SENSe]:EEVM:AVERAge:COUNt <integer> . . . . .	380
[:SENSe]:EEVM:AVERAge:COUNt? . . . . .	380
[:SENSe]:EEVM:AVERAge:TCONtrol EXPonential   REPeat . . . . .	381
[:SENSe]:EEVM:AVERAge:TCONtrol? . . . . .	381
[:SENSe]:EEVM:AVERAge[:STATe] OFF   ON   0   1 . . . . .	380
[:SENSe]:EEVM:AVERAge[:STATe]? . . . . .	380
[:SENSe]:EEVM:BSYNc:SOURce RFBurst   TSEQUence   NONE . . . . .	381
[:SENSe]:EEVM:BSYNc:SOURce? . . . . .	381
[:SENSe]:EEVM:BSYNc:SOURce? . . . . .	381
[:SENSe]:EEVM:DROop OFF   ON   0   1 . . . . .	382
[:SENSe]:EEVM:DROop? . . . . .	382
[:SENSe]:EEVM:ELIMit OFF   ON   0   1 . . . . .	382
[:SENSe]:EEVM:ELIMit? . . . . .	382
[:SENSe]:EEVM:FERRor:TRANge WIDE   NORMal . . . . .	382

---

# List of Commands

[:SENSe]:EEVM:FERRor:TRANge? .....	.382
[:SENSe]:EEVM:SDOTs[:STATe] OFF   ON   0   1 .....	.383
[:SENSe]:EEVM:SDOTs[:STATe]? .....	.383
[:SENSe]:EEVM:TRACe:SDOTs <integer> .....	.383
[:SENSe]:EEVM:TRACe:SDOTs? .....	.383
[:SENSe]:EEVM:TRIGger:SOURce EXTernal[1]   EXTernal2   FRAMe   IF   IMMEDIATE   RFBurst.	383
[:SENSe]:EEVM:TRIGger:SOURce IMMEDIATE   RFBurst   EXTernal   FRAMe .....	.383
[:SENSe]:EEVM:TRIGger:SOURce? .....	.383
[:SENSe]:EEVM:TRIGger:SOURce? .....	.383
[:SENSe]:EEVM:TYPE:LIMit NORMAl   EXTRemE .....	.384
[:SENSe]:EEVM:TYPE:LIMit? .....	.384
[:SENSe]:EORFSpectrum:DETEctor:SWITChing:FAST[:STATe] OFF   ON   0   1 .....	.390
[:SENSe]:EORFSpectrum:DETEctor:SWITChing? .....	.390
[:SENSe]:EORFspectr:AVERAge:COUNt <integer> .....	.385
[:SENSe]:EORFspectr:AVERAge:COUNt? .....	.385
[:SENSe]:EORFspectr:AVERAge:FAST[:STATe] OFF   ON   0   1 .....	.385
[:SENSe]:EORFspectr:AVERAge:FAST[:STATe]? .....	.385
[:SENSe]:EORFspectr:AVERAge:MODulation:TYPE LOG   RMS. ....	.386
[:SENSe]:EORFspectr:AVERAge:MODulation:TYPE? .....	.386
[:SENSe]:EORFspectr:AVERAge[:STATe] OFF   ON   0   1 .....	.386
[:SENSe]:EORFspectr:AVERAge[:STATe]? .....	.386
[:SENSe]:EORFspectr:BANDwidth[:RESolution] :MODulation:OFFSet:CLOSe <freq> .....	.387
[:SENSe]:EORFspectr:BANDwidth[:RESolution] :MODulation:OFFSet:CLOSe? .....	.387
[:SENSe]:EORFspectr:BANDwidth[:RESolution] :MODulation:OFFSet:FAR <freq> .....	.388
[:SENSe]:EORFspectr:BANDwidth[:RESolution] :MODulation:OFFSet:FAR? .....	.388
[:SENSe]:EORFspectr:BANDwidth[:RESolution] :SWITChing:OFFSet:CLOSe <freq> .....	.389
[:SENSe]:EORFspectr:BANDwidth[:RESolution] :SWITChing:OFFSet:CLOSe? .....	.389

---

# List of Commands

[[:SENSE]:EORFspectr:BANDwidth[:RESolution] :SWITching:OFFSet:FAR <freq> . . . . .	389
[[:SENSE]:EORFspectr:BANDwidth[:RESolution] :SWITching:OFFSet:FAR? . . . . .	389
[[:SENSE]:EORFspectr:BANDwidth   BWIDth[:RESolution] :MODulation:CARRier <freq> . . . . .	386
[[:SENSE]:EORFspectr:BANDwidth   BWIDth[:RESolution] :MODulation:CARRier? . . . . .	386
[[:SENSE]:EORFspectr:BANDwidth   BWIDth[:RESolution] :MODulation:OFFSet:CLOSe <freq>. . . . .	387
[[:SENSE]:EORFspectr:BANDwidth   BWIDth[:RESolution] :MODulation:OFFSet:CLOSe? . . . . .	387
[[:SENSE]:EORFspectr:BANDwidth   BWIDth[:RESolution] :MODulation:OFFSet:FAR <freq> . . . . .	387
[[:SENSE]:EORFspectr:BANDwidth   BWIDth[:RESolution] :MODulation:OFFSet:FAR? . . . . .	388
[[:SENSE]:EORFspectr:BANDwidth   BWIDth[:RESolution] :SWITching:CARRier <freq> . . . . .	388
[[:SENSE]:EORFspectr:BANDwidth   BWIDth[:RESolution] :SWITching:CARRier? . . . . .	388
[[:SENSE]:EORFspectr:BANDwidth   BWIDth[:RESolution] :SWITching:OFFSet:CLOSe <freq>. . . . .	389
[[:SENSE]:EORFspectr:BANDwidth   BWIDth[:RESolution] :SWITching:OFFSet:CLOSe? . . . . .	389
[[:SENSE]:EORFspectr:BANDwidth   BWIDth[:RESolution] :SWITching:OFFSet:FAR <freq> . . . . .	389
[[:SENSE]:EORFspectr:BANDwidth   BWIDth[:RESolution] :SWITching:OFFSet:FAR? . . . . .	389
[[:SENSE]:EORFspectr:BFRequency <freq>. . . . .	390
[[:SENSE]:EORFspectr:BFRequency? . . . . .	390
[[:SENSE]:EORFspectr:LIST:MODulation:APPLy RELative   BOTH   ABSolute{,RELative   BOTH   ABSolute} . . . . .	391
[[:SENSE]:EORFspectr:LIST:MODulation:APPLy? . . . . .	391
[[:SENSE]:EORFspectr:LIST:MODulation:BANDwidth   BWIDth <res bw>{,<res bw>} . . . . .	392
[[:SENSE]:EORFspectr:LIST:MODulation:BANDwidth   BWIDth? . . . . .	392
[[:SENSE]:EORFspectr:LIST:MODulation:LOFFset [:RCARRier]<level>{,<level>}. . . . .	394

---

# List of Commands

[:SENSe]:EORFspectr:LIST:MODulation:LOFFset [:RCARrier]? .....	.394
[:SENSe]:EORFspectr:LIST:MODulation:LOFFset:ABSolute <level>{,<level>} .....	.393
[:SENSe]:EORFspectr:LIST:MODulation:LOFFset:ABSolute? .....	.393
[:SENSe]:EORFspectr:LIST:MODulation:STATe OFF   ON   0   1{,OFF   ON   0   1} .....	.392
[:SENSe]:EORFspectr:LIST:MODulation:STATe? .....	.393
[:SENSe]:EORFspectr:LIST:MODulation[:FREQuency] <offset freq>{,<offset freq>} .....	.392
[:SENSe]:EORFspectr:LIST:MODulation[:FREQuency]? .....	.392
[:SENSe]:EORFspectr:LIST:SElect CUSTom   SHORt   STANdard .....	.395
[:SENSe]:EORFspectr:LIST:SElect SHORt   STANdard .....	.395
[:SENSe]:EORFspectr:LIST:SElect? .....	.395
[:SENSe]:EORFspectr:LIST:SElect? .....	.395
[:SENSe]:EORFspectr:LIST:SWITching:APPLy RELative   BOTH   ABSolute{,RELative   BOTH   ABSolute} .....	.396
[:SENSe]:EORFspectr:LIST:SWITching:APPLy? .....	.396
[:SENSe]:EORFspectr:LIST:SWITching:BANDwidth   BWIDth <res bw>{,<res bw>} .....	.398
[:SENSe]:EORFspectr:LIST:SWITching:BANDwidth   BWIDth? .....	.398
[:SENSe]:EORFspectr:LIST:SWITching:LOFFset [:RCARrier] <level>{,<level>} .....	.399
[:SENSe]:EORFspectr:LIST:SWITching:LOFFset [:RCARrier]? .....	.399
[:SENSe]:EORFspectr:LIST:SWITching:LOFFset:ABSolute <level>{,<level>} .....	.396
[:SENSe]:EORFspectr:LIST:SWITching:LOFFset:ABSolute? .....	.397
[:SENSe]:EORFspectr:LIST:SWITching:STATe OFF   ON   0   1{,OFF   ON   0   1} .....	.397
[:SENSe]:EORFspectr:LIST:SWITching:STATe? .....	.397
[:SENSe]:EORFspectr:LIST:SWITching[:FREQuency] <offset freq>{,<offset freq>} .....	.397
[:SENSe]:EORFspectr:LIST:SWITching[:FREQuency] <offset freq>{,<offset freq>} .....	.399
[:SENSe]:EORFspectr:LIST:SWITching[:FREQuency]? .....	.397
[:SENSe]:EORFspectr:LIST:SWITching[:FREQuency]? .....	.399
[:SENSe]:EORFspectr:MEASure MULTiple   SINGLE   SWEPT .....	.391
[:SENSe]:EORFspectr:MEASure MULTiple   SINGLE   SWEPT .....	.400
[:SENSe]:EORFspectr:MEASure? .....	.391
[:SENSe]:EORFspectr:MEASure? .....	.400
[:SENSe]:EORFspectr:OFRequency <freq> .....	.400

---

## List of Commands

[:SENSe]:EORFspectr:OFRequency? . . . . .	400
[:SENSe]:EORFspectr:TRIGger:SOURce EXTernal[1]   EXTernal2   FRAMe   IMMEDIATE   RFBurst. . . . .	401
[:SENSe]:EORFspectr:TRIGger:SOURce EXTernal   FRAMe   RFBurst . . . . .	401
[:SENSe]:EORFspectr:TRIGger:SOURce? . . . . .	401
[:SENSe]:EORFspectr:TRIGger:SOURce? . . . . .	401
[:SENSe]:EORFspectr:TYPE MODulation   MSWitching   SWITChing   FFModulation . . . . .	401
[:SENSe]:EORFspectr:TYPE MODulation   SWITChing. . . . .	402
[:SENSe]:EORFspectr:TYPE:MODulation[:METHod] DISCrete   SWEep . . . . .	402
[:SENSe]:EORFspectr:TYPE:MODulation[:METHod]? . . . . .	402
[:SENSe]:EORFspectr:TYPE? . . . . .	402
[:SENSe]:EORFspectr:TYPE? . . . . .	402
[:SENSe]:EPVTime:AVERAge:COUNT <integer> . . . . .	403
[:SENSe]:EPVTime:AVERAge:COUNT? . . . . .	403
[:SENSe]:EPVTime:AVERAge:TCONtrol EXPonential   REPeat . . . . .	403
[:SENSe]:EPVTime:AVERAge:TCONtrol? . . . . .	403
[:SENSe]:EPVTime:AVERAge:TYPE LOG   MAXimum   MINimum   MXMinimum   RMS . . . . .	404
[:SENSe]:EPVTime:AVERAge:TYPE LPOWer   POWer . . . . .	404
[:SENSe]:EPVTime:AVERAge:TYPE? . . . . .	404
[:SENSe]:EPVTime:AVERAge:TYPE? . . . . .	404
[:SENSe]:EPVTime:AVERAge[:STATe] OFF   ON   0   1. . . . .	403
[:SENSe]:EPVTime:AVERAge[:STATe]? . . . . .	403
[:SENSe]:EPVTime:BANDwidth   BWIDth[:RESolution] <freq>. . . . .	405
[:SENSe]:EPVTime:BANDwidth   BWIDth[:RESolution]:TYPE FLATtop   GAUSSian . . . . .	405
[:SENSe]:EPVTime:BANDwidth   BWIDth[:RESolution]:TYPE? . . . . .	405
[:SENSe]:EPVTime:BANDwidth   BWIDth[:RESolution]? . . . . .	405
[:SENSe]:EPVTime:BSYNc:SLENgth EVEN   INTeger . . . . .	405
[:SENSe]:EPVTime:BSYNc:SLENgth? . . . . .	405
[:SENSe]:EPVTime:BSYNc:SOURce TSEQUence   RFBurst   NONE . . . . .	406
[:SENSe]:EPVTime:BSYNc:SOURce? . . . . .	406
[:SENSe]:EPVTime:LIMit:MASK OFF   ON   0   1 . . . . .	407

---

# List of Commands

[:SENSe]:EPVTime:LIMit:MASK? .....	407
[:SENSe]:EPVTime:MASK:LIST:LOWer:ABSolute <power>,<power>,<power>,<power>,<power>,.....	407
[:SENSe]:EPVTime:MASK:LIST:LOWer:ABSolute? .....	407
[:SENSe]:EPVTime:MASK:LIST:LOWer:POINts? .....	408
[:SENSe]:EPVTime:MASK:LIST:LOWer:RELative <rel_power>,<rel_power>,<rel_power>,<rel_power>,<rel_power>,.....	408
[:SENSe]:EPVTime:MASK:LIST:LOWer:RELative? .....	408
[:SENSe]:EPVTime:MASK:LIST:LOWer:TIME <seconds>,<seconds>,<seconds>,<seconds>,<seconds>,.....	409
[:SENSe]:EPVTime:MASK:LIST:LOWer:TIME? .....	409
[:SENSe]:EPVTime:MASK:LIST:UPPer:ABSolute <power>,<power>,<power>,<power>,<power>,.....	409
[:SENSe]:EPVTime:MASK:LIST:UPPer:ABSolute? .....	409
[:SENSe]:EPVTime:MASK:LIST:UPPer:POINts? .....	410
[:SENSe]:EPVTime:MASK:LIST:UPPer:RELative <rel_power>,<rel_power>,<rel_power>,<rel_power>,<rel_power>,.....	410
[:SENSe]:EPVTime:MASK:LIST:UPPer:RELative? .....	410
[:SENSe]:EPVTime:MASK:LIST:UPPer:TIME <seconds>,<seconds>,<seconds>,<seconds>,<seconds>,.....	412
[:SENSe]:EPVTime:MASK:LIST:UPPer:TIME? .....	412
[:SENSe]:EPVTime:MASK:SELEct STANdard   CUSTom .....	412
[:SENSe]:EPVTime:MASK:SELEct? .....	412
[:SENSe]:EPVTime:PCLevel <integer> .....	415
[:SENSe]:EPVTime:PCLevel? .....	415
[:SENSe]:EPVTime:SWEep:TIME <integer> .....	415
[:SENSe]:EPVTime:SWEep:TIME? .....	415
[:SENSe]:EPVTime:TRIGger:SOURce EXTErnal[1]   EXTErnal2   FRAMe   IF   IMMEDIATE   RFBurst .....	416
[:SENSe]:EPVTime:TRIGger:SOURce RFBurst   EXTErnal   FRAMe .....	416
[:SENSe]:EPVTime:TRIGger:SOURce? .....	416
[:SENSe]:EPVTime:TRIGger:SOURce? .....	416
[:SENSe]:ETSPur:AVERage:COUNt <integer> .....	418
[:SENSe]:ETSPur:AVERage:COUNt? .....	418

---

# List of Commands

[:SENSe]:ETSPur:AVERage:TCONtrol EXPonential   REPeat	418
[:SENSe]:ETSPur:AVERage:TCONtrol?	418
[:SENSe]:ETSPur:AVERage:TYPE LOG   MAXimum   RMS	419
[:SENSe]:ETSPur:AVERage:TYPE?	419
[:SENSe]:ETSPur:AVERage[:STATe] OFF   ON   0   1	418
[:SENSe]:ETSPur:AVERage[:STATe]?	418
[:SENSe]:ETSPur:TYPE EXAMine   FULL	419
[:SENSe]:ETSPur:TYPE?	419
[:SENSe]:FEED RF   AREFERENCE   IFALign   WBALign	420
[:SENSe]:FEED RF   IQ   IONLy   QONLy   AREFERENCE   IFALign	420
[:SENSe]:FEED?	420
[:SENSe]:FREQuency:CENTer <freq>	422
[:SENSe]:FREQuency:CENTer:STEP[:INCRement] <freq>	422
[:SENSe]:FREQuency:CENTer:STEP[:INCRement]?	422
[:SENSe]:FREQuency:CENTer?	422
[:SENSe]:ORFSpectrum:AVERage:COUNt <integer>	424
[:SENSe]:ORFSpectrum:AVERage:COUNt?	424
[:SENSe]:ORFSpectrum:AVERage:FAST[:STATe] OFF   ON   0   1	424
[:SENSe]:ORFSpectrum:AVERage:FAST[:STATe]?	424
[:SENSe]:ORFSpectrum:AVERage:MODulation:TYPE LOG   RMS	425
[:SENSe]:ORFSpectrum:AVERage:MODulation:TYPE?	425
[:SENSe]:ORFSpectrum:AVERage:SWITching:TYPE?	425
[:SENSe]:ORFSpectrum:AVERage[:STATe] OFF   ON   0   1	425
[:SENSe]:ORFSpectrum:AVERage[:STATe]?	425
[:SENSe]:ORFSpectrum:BANDwidth   BWIDth[:RESolution] :MODulation:CARRier <freq>	426
[:SENSe]:ORFSpectrum:BANDwidth   BWIDth[:RESolution] :MODulation:CARRier?	426
[:SENSe]:ORFSpectrum:BANDwidth   BWIDth[:RESolution] :MODulation:OFFSet:CLOSe <freq>	426
[:SENSe]:ORFSpectrum:BANDwidth   BWIDth[:RESolution] :MODulation:OFFSet:CLOSe?	426

---

# List of Commands

[:SENSe]:ORFSpectrum:BANDwidth   BWIDth[:RESolution] :MODulation:OFFSet:FAR <freq> .....	426
[:SENSe]:ORFSpectrum:BANDwidth   BWIDth[:RESolution] :MODulation:OFFSet:FAR? .....	427
[:SENSe]:ORFSpectrum:BANDwidth   BWIDth[:RESolution] :SWITching:CARRier <freq> .....	427
[:SENSe]:ORFSpectrum:BANDwidth   BWIDth[:RESolution] :SWITching:CARRier? .....	427
[:SENSe]:ORFSpectrum:BANDwidth   BWIDth[:RESolution] :SWITching:OFFSet:CLOSe <freq> .....	427
[:SENSe]:ORFSpectrum:BANDwidth   BWIDth[:RESolution] :SWITching:OFFSet:CLOSe? .....	427
[:SENSe]:ORFSpectrum:BANDwidth   BWIDth[:RESolution] :SWITching:OFFSet:FAR <freq> .....	428
[:SENSe]:ORFSpectrum:BANDwidth   BWIDth[:RESolution] :SWITching:OFFSet:FAR? .....	428
[:SENSe]:ORFSpectrum:BFRequency <freq> .....	428
[:SENSe]:ORFSpectrum:BFRequency? .....	428
[:SENSe]:ORFSpectrum:DETEctor:SWITching:FAST[:STATe] OFF   ON   0   1 .....	429
[:SENSe]:ORFSpectrum:DETEctor:SWITching? .....	429
[:SENSe]:ORFSpectrum:LIST:MODulation:APPLY RELative   BOTH   ABSolute{,RELA- tive   BOTH   ABSolute} .....	423
[:SENSe]:ORFSpectrum:LIST:MODulation:APPLY? .....	423
[:SENSe]:ORFSpectrum:LIST:MODulation:BANDwidth   BWIDth <res bw>{,<res bw>} .....	429
[:SENSe]:ORFSpectrum:LIST:MODulation:BANDwidth   BWIDth? .....	429
[:SENSe]:ORFSpectrum:LIST:MODulation:LOFFset:ABSolute <level>{,<level>} .....	430
[:SENSe]:ORFSpectrum:LIST:MODulation:LOFFset:ABSolute? .....	431
[:SENSe]:ORFSpectrum:LIST:MODulation:LOFFset[:RCARRier] <level>{,<level>} .....	430
[:SENSe]:ORFSpectrum:LIST:MODulation:LOFFset[:RCARRier]? .....	430
[:SENSe]:ORFSpectrum:LIST:MODulation:STATe OFF   ON   0   1{,OFF   ON   0   1} .....	431
[:SENSe]:ORFSpectrum:LIST:MODulation:STATe? .....	431
[:SENSe]:ORFSpectrum:LIST:MODulation[:FREQuency] <offset freq>{,<offset freq>} .....	431
[:SENSe]:ORFSpectrum:LIST:MODulation[:FREQuency]? .....	431



---

# List of Commands

[:SENSe]:ORFSpectrum:LIST:SElect CUSTom   SHORt   STANdard	432
[:SENSe]:ORFSpectrum:LIST:SElect?	432
[:SENSe]:ORFSpectrum:LIST:SWITching:APPLy <RELative   BOTH   ABSolute>{,<RELative   BOTH   ABSolute>}	433
[:SENSe]:ORFSpectrum:LIST:SWITching:APPLy?	433
[:SENSe]:ORFSpectrum:LIST:SWITching:BANDwidth   BWIDth <res_bw>{,<res_bw>}	434
[:SENSe]:ORFSpectrum:LIST:SWITching:BANDwidth   BWIDth?	434
[:SENSe]:ORFSpectrum:LIST:SWITching:LOFFset:ABSolute <level>{,<level>}	435
[:SENSe]:ORFSpectrum:LIST:SWITching:LOFFset:ABSolute?	435
[:SENSe]:ORFSpectrum:LIST:SWITching:LOFFset[:RCARrier] <level>{,<level>}	434
[:SENSe]:ORFSpectrum:LIST:SWITching:LOFFset[:RCARrier]?	434
[:SENSe]:ORFSpectrum:LIST:SWITching:STATe OFF   ON   0   1{,OFF   ON   0   1}	436
[:SENSe]:ORFSpectrum:LIST:SWITching:STATe?	436
[:SENSe]:ORFSpectrum:LIST:SWITching[:FREQuency] <offset freq>{,<offset freq>}	436
[:SENSe]:ORFSpectrum:LIST:SWITching[:FREQuency]?	436
[:SENSe]:ORFSpectrum:MEASure MULTiple   SINGLE   SWEpt.	437
[:SENSe]:ORFSpectrum:MEASure?	437
[:SENSe]:ORFSpectrum:MEASure?	437
[:SENSe]:ORFSpectrum:OFRequency <freq>	438
[:SENSe]:ORFSpectrum:OFRequency?	438
[:SENSe]:ORFSpectrum:TRIGger:SOURce EXTernal[1]   EXTernal2   FRAMe   IMMEDIATE   RFBurst	438
[:SENSe]:ORFSpectrum:TRIGger:SOURce?	438
[:SENSe]:ORFSpectrum:TYPE MODulation   MSWitching   SWITching   FFModulation.	439
[:SENSe]:ORFSpectrum:TYPE?	439
[:SENSe]:PFERror:AVERage:COUNt <integer>	440
[:SENSe]:PFERror:AVERage:COUNt?	440
[:SENSe]:PFERror:AVERage:TCONtrol EXPonential   REPeat.	440
[:SENSe]:PFERror:AVERage:TCONtrol?	440
[:SENSe]:PFERror:AVERage:TYPE MEAN   MAXimum	441
[:SENSe]:PFERror:AVERage:TYPE?	441

---

# List of Commands

[:SENSe]:PFERror:AVERage[:STATe] OFF   ON   0   1	440
[:SENSe]:PFERror:AVERage[:STATe]?	440
[:SENSe]:PFERror:BSYNc:SOURce EXTernal[1]   EXTernal2   NONE   RFBurst   TSEquence	441
[:SENSe]:PFERror:BSYNc:SOURce?	441
[:SENSe]:PFERror:IQOFfset[:STATe] OFF   ON   0   1	441
[:SENSe]:PFERror:IQOFfset[:STATe]?	441
[:SENSe]:PFERror:TRACe[:STATe] OFF   ON   0   1	442
[:SENSe]:PFERror:TRACe[:STATe]?	442
[:SENSe]:PFERror:TRIGger:SOURce EXTernal[1]   EXTernal2   FRAMe   IF   IMMEDIATE   RFBurst	442
[:SENSe]:PFERror:TRIGger:SOURce?	442
[:SENSe]:POWer:IQ:RANGe[:UPPer] <Float 64>{DBM}   DBMV   W	443
[:SENSe]:POWer:IQ:RANGe[:UPPer] <power> [DBM]   DBMV   W	372
[:SENSe]:POWer:IQ:RANGe[:UPPer]?	372
[:SENSe]:POWer:IQ:RANGe[:UPPer]?	443
[:SENSe]:POWer[:RF]:ATTenuation <rel_power>	444
[:SENSe]:POWer[:RF]:ATTenuation?	444
[:SENSe]:POWer[:RF]:GAIN:ATTenuation <integer>	444
[:SENSe]:POWer[:RF]:GAIN[:STATe] ON   OFFMecha Atten	444
[:SENSe]:POWer[:RF]:RANGe:AUTO OFF   ON   0   1	445
[:SENSe]:POWer[:RF]:RANGe:AUTO?	445
[:SENSe]:POWer[:RF]:RANGe[:UPPer] <power>	445
[:SENSe]:POWer[:RF]:RANGe[:UPPer]?	445
[:SENSe]:PVTime:AVERage:COUNT <integer>	447
[:SENSe]:PVTime:AVERage:COUNT?	447
[:SENSe]:PVTime:AVERage:TCONtrol EXPONential   REPEAT	448
[:SENSe]:PVTime:AVERage:TCONtrol?	448
[:SENSe]:PVTime:AVERage:TYPE LOG   MAXimum   MINimum   MXMinimum   RMS	448
[:SENSe]:PVTime:AVERage:TYPE LOG   MAXimum   MINimum   MXMinimum   RMS   POWer	448
[:SENSe]:PVTime:AVERage:TYPE LOG   MAXimum   MINimum   RMS   SCALar	448
[:SENSe]:PVTime:AVERage:TYPE RMS   MAXimum   MINimum	448

---

# List of Commands

[[:SENSe]:PVTime:AVERAge:TYPE? .....	448
[[:SENSe]:PVTime:AVERAge[:STATe] OFF   ON   0   1 .....	447
[[:SENSe]:PVTime:AVERAge[:STATe]? .....	447
[[:SENSe]:PVTime:BANDwidth   BWIDth[:RESolution] <freq> .....	449
[[:SENSe]:PVTime:BANDwidth   BWIDth[:RESolution]:TYPE FLATtop   GAUSSian .....	450
[[:SENSe]:PVTime:BANDwidth   BWIDth[:RESolution]:TYPE? .....	450
[[:SENSe]:PVTime:BANDwidth   BWIDth[:RESolution]? .....	449
[[:SENSe]:PVTime:BSYNc:SLENgth EVEN   INTeger .....	450
[[:SENSe]:PVTime:BSYNc:SLENgth? .....	450
[[:SENSe]:PVTime:BSYNc:SOURce TSEQUence   RFBurst   NONE .....	451
[[:SENSe]:PVTime:BSYNc:SOURce? .....	451
[[:SENSe]:PVTime:LIMit:MASK OFF   ON   0   1 .....	452
[[:SENSe]:PVTime:LIMit:MASK? .....	452
[[:SENSe]:PVTime:MASK:LIST:LOWer:ABSolute <power>,<power>,<power>,<power>,<power>,... .....	452
[[:SENSe]:PVTime:MASK:LIST:LOWer:ABSolute? .....	452
[[:SENSe]:PVTime:MASK:LIST:LOWer:POINts? .....	453
[[:SENSe]:PVTime:MASK:LIST:LOWer:RELative <rel_power>,<rel_power>,<rel_power>,<rel_power>,<rel_power>,... .....	453
[[:SENSe]:PVTime:MASK:LIST:LOWer:RELative? .....	453
[[:SENSe]:PVTime:MASK:LIST:LOWer:TIME <seconds>{,<seconds>} .....	454
[[:SENSe]:PVTime:MASK:LIST:LOWer:TIME? .....	454
[[:SENSe]:PVTime:MASK:LIST:UPPer:ABSolute <power>,<power>,<power>,<power>,<power>,... .....	455
[[:SENSe]:PVTime:MASK:LIST:UPPer:ABSolute? .....	455
[[:SENSe]:PVTime:MASK:LIST:UPPer:POINts? .....	455
[[:SENSe]:PVTime:MASK:LIST:UPPer:RELative <rel_power>, <rel_power>,<rel_power>,<rel_power>,<rel_power>,... .....	456
[[:SENSe]:PVTime:MASK:LIST:UPPer:RELative? .....	456
[[:SENSe]:PVTime:MASK:LIST:UPPer:TIME <seconds>,<seconds>,<seconds>,<seconds>,<seconds>,... .....	457
[[:SENSe]:PVTime:MASK:LIST:UPPer:TIME? .....	457
[[:SENSe]:PVTime:MASK:SELEct STANdard   CUSTom .....	458

---

# List of Commands

[:SENSe]:PVTime:MASK:SElect?	458
[:SENSe]:PVTime:PCLevel <integer>	460
[:SENSe]:PVTime:PCLevel?	460
[:SENSe]:PVTime:SWEEP:TIME <integer>	461
[:SENSe]:PVTime:SWEEP:TIME?	461
[:SENSe]:PVTime:TRIGger:SOURce EXTernal[1]   EXTernal2   FRAMe   IF   IMMEDIATE   RFBURSt	461
[:SENSe]:PVTime:TRIGger:SOURce?	461
[:SENSe]:RADio:CARRier:HOP OFF   ON   0   1	463
[:SENSe]:RADio:CARRier:HOP?	463
[:SENSe]:RADio:CARRier:NUMber SINGLE   MULTiple	463
[:SENSe]:RADio:CARRier:NUMber?	463
[:SENSe]:RADio:CARRier[:TYPE] BURSt   CONTInuous	464
[:SENSe]:RADio:CARRier[:TYPE]?	464
[:SENSe]:RADio:DEVice BTS   MS	464
[:SENSe]:RADio:DEVice:BASE[:TYPE] NORMAl   MICRo   MICR1   MICR2   MICR3   PICO	464
[:SENSe]:RADio:DEVice:BASE[:TYPE]?	464
[:SENSe]:RADio:DEVice?	464
[:SENSe]:RADio:STANdard:BAND PGSM   EGSM   RGSM   DCS1800   PCS1900   GSM450   GSM480   GSM700   GSM850	465
[:SENSe]:RADio:STANdard:BAND?	465
[:SENSe]:ROSCillator:EXTernal:FREQuency <frequency>	468
[:SENSe]:ROSCillator:EXTernal:FREQuency?	468
[:SENSe]:ROSCillator:OUTPut?	468
[:SENSe]:ROSCillator:OUTPut[:STATe] OFF   ON   0   1	468
[:SENSe]:ROSCillator:SOURce INTernal   EXTernal	468
[:SENSe]:ROSCillator:SOURce?	468
[:SENSe]:SPECTrum:ACQuisition:PACKing AUTO   LONG   MEDium   SHORt	471
[:SENSe]:SPECTrum:ACQuisition:PACKing?	471
[:SENSe]:SPECTrum:ADC:DITHer[:STATe] AUTO   ON   OFF   2   1   0	471
[:SENSe]:SPECTrum:ADC:DITHer[:STATe]?	471
[:SENSe]:SPECTrum:ADC:RANGe AUTO   APeak   APlock   M6   P0   P6   P12   P18   P24	472

---

## List of Commands

[:SENSe]:SPECtrum:ADC:RANGe AUTO   APEak   APLOCK   NONE   P0   P6   P12   P18 . . . . .	472
[:SENSe]:SPECtrum:ADC:RANGe? . . . . .	472
[:SENSe]:SPECtrum:AVERAge:CLEar . . . . .	473
[:SENSe]:SPECtrum:AVERAge:COUNT <integer> . . . . .	473
[:SENSe]:SPECtrum:AVERAge:COUNT? . . . . .	473
[:SENSe]:SPECtrum:AVERAge:TCONtrol EXPonential   REPeat . . . . .	474
[:SENSe]:SPECtrum:AVERAge:TCONtrol? . . . . .	474
[:SENSe]:SPECtrum:AVERAge:TYPE LOG   MAXimum   MINimum   RMS   SCALar . . . . .	474
[:SENSe]:SPECtrum:AVERAge:TYPE? . . . . .	475
[:SENSe]:SPECtrum:AVERAge[:STATe] OFF   ON   0   1 . . . . .	474
[:SENSe]:SPECtrum:AVERAge[:STATe]? . . . . .	474
[:SENSe]:SPECtrum:BANDwidth   BWIDth:IF:AUTO OFF   ON   0   1 . . . . .	475
[:SENSe]:SPECtrum:BANDwidth   BWIDth:IF:AUTO? . . . . .	475
[:SENSe]:SPECtrum:BANDwidth   BWIDth:IF:FLATness OFF   ON   0   1 . . . . .	476
[:SENSe]:SPECtrum:BANDwidth   BWIDth:IF:FLATness? . . . . .	476
[:SENSe]:SPECtrum:BANDwidth   BWIDth:PADC OFF   ON   0   1 . . . . .	476
[:SENSe]:SPECtrum:BANDwidth   BWIDth:PADC? . . . . .	476
[:SENSe]:SPECtrum:BANDwidth   BWIDth:PFFT:TYPE FLAT   GAUSSian . . . . .	477
[:SENSe]:SPECtrum:BANDwidth   BWIDth:PFFT:TYPE? . . . . .	477
[:SENSe]:SPECtrum:BANDwidth   BWIDth:PFFT[:SIZE] <freq> . . . . .	476
[:SENSe]:SPECtrum:BANDwidth   BWIDth:PFFT[:SIZE]? . . . . .	476
[:SENSe]:SPECtrum:BANDwidth   BWIDth[:RESolution] <freq> . . . . .	478
[:SENSe]:SPECtrum:BANDwidth   BWIDth[:RESolution]:AUTO OFF   ON   0   1 . . . . .	478
[:SENSe]:SPECtrum:BANDwidth   BWIDth[:RESolution]:AUTO? . . . . .	478
[:SENSe]:SPECtrum:BANDwidth   BWIDth[:RESolution]? . . . . .	478
[:SENSe]:SPECtrum:DECimate[:FACTor] <integer> . . . . .	478
[:SENSe]:SPECtrum:DECimate[:FACTor]? . . . . .	479
[:SENSe]:SPECtrum:FFT:LENGth <integer> . . . . .	479
[:SENSe]:SPECtrum:FFT:LENGth:AUTO OFF   ON   0   1 . . . . .	480
[:SENSe]:SPECtrum:FFT:LENGth:AUTO? . . . . .	480
[:SENSe]:SPECtrum:FFT:LENGth? . . . . .	479

---

# List of Commands

[:SENSe]:SPECTrum:FFT:RBWPoints <real> .....	480
[:SENSe]:SPECTrum:FFT:RBWPoints? .....	480
[:SENSe]:SPECTrum:FFT:WINDow:DELay <real> .....	481
[:SENSe]:SPECTrum:FFT:WINDow:DELay? .....	481
[:SENSe]:SPECTrum:FFT:WINDow:LENGth <integer> .....	481
[:SENSe]:SPECTrum:FFT:WINDow:LENGth? .....	481
[:SENSe]:SPECTrum:FFT:WINDow[:TYPE] BH4Tap   BLACkman   FLATtop   GAUSSian   HAM- Ming   HANNing   KB70   KB90   KB110   UNIFORM .....	482
[:SENSe]:SPECTrum:FFT:WINDow[:TYPE]? .....	482
[:SENSe]:SPECTrum:FREQuency:SPAN <freq> .....	482
[:SENSe]:SPECTrum:FREQuency:SPAN? .....	482
[:SENSe]:SPECTrum:SWEep:TIME:AUTO OFF   ON   0   1 .....	483
[:SENSe]:SPECTrum:SWEep:TIME:AUTO .....	483
[:SENSe]:SPECTrum:SWEep:TIME? .....	483
[:SENSe]:SPECTrum:SWEep:TIME[:VALue] <time> .....	483
[:SENSe]:SPECTrum:TRIGger:SOURce EXTernal[1]   EXTernal2   FRAME   IF   LINE   IMMEDIATE   RFBurst .....	484
[:SENSe]:SPECTrum:TRIGger:SOURce? .....	484
[:SENSe]:SYNC:ALIGnment GSM   HBIT .....	486
[:SENSe]:SYNC:ALIGnment? .....	486
[:SENSe]:SYNC:BURSt:RFAMplitude:DELay <time> .....	486
[:SENSe]:SYNC:BURSt:RFAMplitude:DELay? .....	486
[:SENSe]:SYNC:BURSt:STHReshold <rel_power> .....	486
[:SENSe]:SYNC:BURSt:STHReshold? .....	486
[:SENSe]:TSPur:AVERAge:COUNt <integer> .....	487
[:SENSe]:TSPur:AVERAge:COUNt? .....	487
[:SENSe]:TSPur:AVERAge:TCONtrol EXPonential   REPeat .....	488
[:SENSe]:TSPur:AVERAge:TCONtrol? .....	488
[:SENSe]:TSPur:AVERAge:TYPE LOG   MAXimum   RMS .....	488
[:SENSe]:TSPur:AVERAge:TYPE? .....	488
[:SENSe]:TSPur:AVERAge[:STATe] OFF   ON   0   1 .....	487
[:SENSe]:TSPur:AVERAge[:STATe]? .....	488

---

# List of Commands

[[:SENSe]:TSPur:TYPE EXAMine   FULL	489
[[:SENSe]:TSPur:TYPE?	489
[[:SENSe]:TXPower:AVERage:COUNT <integer>	490
[[:SENSe]:TXPower:AVERage:COUNT?	490
[[:SENSe]:TXPower:AVERage:TCONtrol EXPonential   REPEAT.	490
[[:SENSe]:TXPower:AVERage:TCONtrol?	490
[[:SENSe]:TXPower:AVERage:TYPE   LOG   MAX   MIN   RMS	491
[[:SENSe]:TXPower:AVERage:TYPE?	491
[[:SENSe]:TXPower:AVERage[:STATe] OFF   ON   0   1	490
[[:SENSe]:TXPower:AVERage[:STATe]?	490
[[:SENSe]:TXPower:BANDwidth   BWIDth[:RESolution] <freq>	491
[[:SENSe]:TXPower:BANDwidth   BWIDth[:RESolution]:TYPE FLAT   GAUSSian	491
[[:SENSe]:TXPower:BANDwidth   BWIDth[:RESolution]:TYPE?	491
[[:SENSe]:TXPower:BANDwidth   BWIDth[:RESolution]?	491
[[:SENSe]:TXPower:SWEep:TIME <integer>	492
[[:SENSe]:TXPower:SWEep:TIME?	492
[[:SENSe]:TXPower:THReshold <power>	492
[[:SENSe]:TXPower:THReshold:TYPE ABSolute   RELative	493
[[:SENSe]:TXPower:THReshold:TYPE?	493
[[:SENSe]:TXPower:THReshold?	492
[[:SENSe]:TXPower:TRIGger:SOURce EXTernal[1]   EXTernal2   IF   IMMEDIATE   RFBURST	493
[[:SENSe]:TXPower:TRIGger:SOURce?	493
[[:SENSe]:VOLTage:IQ:RANGe[:UPPer] <level>	372
[[:SENSe]:VOLTage:IQ:RANGe[:UPPer]<Float 64> [V]	443
[[:SENSe]:VOLTage:IQ:RANGe[:UPPer]?	373
[[:SENSe]:VOLTage:IQ:RANGe[:UPPer]?	443
[[:SENSe]:WAVEform:ACQuisition:PACKing AUTO   LONG   MEDIUM   SHORT.	494
[[:SENSe]:WAVEform:ACQuisition:PACKing?	494
[[:SENSe]:WAVEform:ADC:DITHer[:STATe] AUTO   ON   OFF   2   1   0	494
[[:SENSe]:WAVEform:ADC:DITHer[:STATe]?	494
[[:SENSe]:WAVEform:ADC:FILTer[:STATe] OFF   ON   0   1.	495

---

# List of Commands

[:SENSe]:WAVeform:ADC:FILTer[:STATe]?	495
[:SENSe]:WAVeform:ADC:RANGe AUTO   APEak   APLOCK   GROund   M6   P0   P6   P12   P18   P24	495
[:SENSe]:WAVeform:ADC:RANGe AUTO   APEak   APLOCK   GROund   NONE   P0   P6   P12   P18	495
[:SENSe]:WAVeform:ADC:RANGe?	495
[:SENSe]:WAVeform:APERture?	496
[:SENSe]:WAVeform:AVERAge:COUNT <integer>	496
[:SENSe]:WAVeform:AVERAge:COUNT?	496
[:SENSe]:WAVeform:AVERAge:TCONtrol EXPonential   REPeat	497
[:SENSe]:WAVeform:AVERAge:TCONtrol?	497
[:SENSe]:WAVeform:AVERAge:TYPE LOG   MAXimum   MINimum   RMS   SCALar	497
[:SENSe]:WAVeform:AVERAge:TYPE?	497
[:SENSe]:WAVeform:AVERAge[:STATe] OFF   ON   0   1	496
[:SENSe]:WAVeform:AVERAge[:STATe]?	497
[:SENSe]:WAVeform:BANDwidth[:RESolution]:ACTual?	498
[:SENSe]:WAVeform:BANDwidth   BWIDth[:RESolution] <freq>	498
[:SENSe]:WAVeform:BANDwidth   BWIDth[:RESolution]:TYPE FLATtop   GAUSSian	499
[:SENSe]:WAVeform:BANDwidth   BWIDth[:RESolution]:TYPE?	499
[:SENSe]:WAVeform:BANDwidth   BWIDth[:RESolution]?	498
[:SENSe]:WAVeform:DECimate:STATe OFF   ON   0   1	500
[:SENSe]:WAVeform:DECimate:STATe?	500
[:SENSe]:WAVeform:DECimate[:FACTor] <integer>	499
[:SENSe]:WAVeform:DECimate[:FACTor]?	499
[:SENSe]:WAVeform:SWEep:TIME <time>	500
[:SENSe]:WAVeform:SWEep:TIME?	500
[:SENSe]:WAVeform:TRIGger:SOURce EXTernal[1]   EXTernal2   FRAMe   IF   IMMEDIATE   LINE   RFBurst	501
[:SENSe]:WAVeform:TRIGger:SOURce?	501



---

# 1 Introduction to GSM and EDGE

This chapter provides overall information on the GSM and EDGE communications systems Options 202 and BAH, and describes GSM and EDGE measurements made by the analyzer. Installation instructions for adding this option to your analyzer are provided in this section, in case you purchased this option separately.

---

## What Do the Agilent PSA Series Option 202 and VSA E4406A Option BAH do?

This instrument personality makes measurements that conform to the ETSI EN 300 910 (GSM 05.05), ETSI EN 300 607.1, (GSM 11.10-1), ETSI EN 301 087 (GSM 11.21), and ANSI J-STD-007 specifications. It also complies with the 3GPP TS 51.021 Base Station System (BSS) equipment specification; Radio Aspects (Release-5) V .5.3.0 (2003-06).

These documents define complex, multi-part measurements used to maintain an interference-free environment. For example, the documents include measuring the power of a carrier. The instrument automatically makes these measurements using the measurement methods and limits defined in the standards. The detailed results displayed by the measurements allow you to analyze GSM and EDGE system performance. You may alter the measurement parameters for specialized analysis.

This instrument was primarily developed for making measurements on digital transmission carriers. These measurements can help determine if a GSM or EDGE transmitter is working correctly. The instrument is capable of measuring the continuous carrier of a base station transmitter.

For infrastructure test, the instrument can test base station transmitters in a non-interfering manner through use of a coupler or power splitter.

This measurement personality makes the following measurements:

- Transmit Power Measurement - see page 113
- GMSK Power vs. Time Measurement - see page 92
- GMSK Phase and Frequency Error Measurement - see page 87
- GMSK Output RF Spectrum (ORFS) Measurement - see page 75
- GMSK Tx Band Spur Measurement - see page 99
- EDGE Power vs. Time Measurement - see page 50
- EDGE Error Vector Magnitude (EVM) Measurement - see page 56
- EDGE Output RF Spectrum (ORFS) Measurement - see page 60
- EDGE Tx Band Spur Measurement - see page 72
- Spectrum (Frequency Domain) Measurement - see page 102
- Waveform (Time Domain) Measurement - see page 117

For conceptual information about these measurements see Chapter 5 , “Concepts,” on page 509 .

---

## Installing Optional Measurement Personalities

When you install a measurement personality, you need to follow a three step process:

1. Determine whether your memory capacity is sufficient to contain all the options you want to load. If not, decide which options you want to install now, and consider upgrading your memory. Details follow in [“Do You Have Enough Memory to Load All Your Personality Options?”](#) on page 35.
2. Install the measurement personality firmware into the instrument memory. Details follow in [“Loading an Optional Measurement Personality”](#) on page 39.
3. Enter a license key number that activates the measurement personality. Details follow in [“Obtaining and Installing a License Key”](#) on page 39.

Adding measurement personalities requires the purchase of a retrofit kit for the desired option. The retrofit kit contains the measurement personality firmware and an entitlement certificate that is used to generate a license key from the internet website. A separate license key is required for each option on a specific instrument serial number and host ID.

### Do You Have Enough Memory to Load All Your Personality Options?

If you want to operate the instrument with four or less personality options installed, you can skip ahead to the next section, [“Loading an Optional Measurement Personality”](#) on page 39. If, after installing your options, you get error messages relating to memory issues, you can return to this section to learn more about how to optimize your configuration.

If you want to install your 5th or 6th option, you should check to see how much memory you have installed.

---

**NOTE**

When you install a firmware package, the installation program will tell you if you have enough memory to install the options you select.

If you have 64 MBytes of memory installed in your instrument, you should have ample memory to install six optional personalities, with plenty of memory to spare for data and states.

If you have less than 64 MBytes of installed memory, depending how much data you save, you are unlikely to have any memory issues until

you want to install your 4th or 5th option. If this is the case, you can either swap the applications in/out of memory as needed, or you can upgrade your hardware to 64 MBytes of memory.

To see the size of your installed memory for PSA Series Spectrum Analyzers:

1. Ensure that the spectrum analyzer is in spectrum analyzer mode because this can affect the screen size.
2. Press the **System** key, **MORE (1 of 3)**, and **Show Hdwr** keys.
3. Read Flash Memory size on the last line of the table.

PSA Flash Memory Size	Available Memory With No Options	Available Memory With Option B7J and/or Option 122
64 Mbytes	33.1 MBytes	30.7 MBytes
48 Mbytes	17.4 MBytes	15.0 MBytes

To see the size of your installed memory for E4406A Transmitter Testers:

1. Press the **System** key, **MORE (1 of 3)**, and **MORE (2 of 3)** keys.
2. Read the **File System Key** - The total of the entries for **Used** and **Free** memory will total the installed flash memory, either 48 or 64 MBytes.

If you have 48 MBytes of memory, and you want to install more than 3 optional personalities, you may need to manage your memory resources. The following section, [“How to Predict Your Memory Requirements” on page 37](#), will help you decide how to configure your installed options to provide optimal operation.

## How to Predict Your Memory Requirements

If you plan to install many optional personalities, you should review your memory requirements, so you can determine whether you have enough memory. There is an Agilent “Memory Calculator” available online that can help you do this, or you can make a calculated approximation using the information that follows. You will need to know your instrument’s installed memory size as determined in the previous section and then select your desired applications.

For E4406A see: [http://www.agilent.com/find/vsa\\_firmware](http://www.agilent.com/find/vsa_firmware)

For PSA series see: [http://www.agilent.com/find/psa\\_firmware](http://www.agilent.com/find/psa_firmware)

Select the “Memory Calculator” link. You can try any combination of available personalities to see if you desired configuration is compatible with your installed memory.

When you install a firmware package, the installation program will also tell you if you have enough memory to install the options you select.

---

### NOTE

For PSA: After loading all your optional measurement personalities, you must retain a reserve of ~2 MBytes of memory to facilitate mode switching. Less available memory will increase mode switching time.

You can estimate your total memory requirements by adding up your projected memory allocations, as described in the following steps. Compare the desired total memory required with the available memory that you identified in the previous section. This especially important if you plan to save many states or screens, as the automated memory calculators described above do not take those allocations into account.

1. Program memory - See “Measurement Personality Options and Memory Required” on page 38.
2. For PSA and VSA: shared libraries require 5.68 MBytes
3. For PSA only: required mode swap space is 2 MBytes
4. Screens - .gif files need 20-25 KBytes each
5. State memory - State file sizes range from 21 KBytes for SA mode to 40 KBytes for W-CDMA. The state of every mode accessed since power-on will be saved in the state file. File sizes can exceed 150 KBytes each when several modes are accessed after power-on.

---

### TIP

State memory retains settings for all states accessed before the **Save State** command. To reduce this usage to a minimum, reduce the modes accessed before the **Save State** is executed. You can set the PSA to boot into a selected mode by assessing the desired mode, then pressing the **System, Power On/Presets, Power On** keys and toggle the setting to **Last**.

### Measurement Personality Options and Memory Required

Personality Options <sup>a</sup> (for PSA series Spectrum Analyzers and E4406A Transmitter Tester)	Option	File Size (PSA Rev: A.07) (E4406A Rev: A.08)
cdmaOne measurement personality	<b>BAC</b>	2.00 Mbytes <sup>b</sup>
NADC and PDC measurement personalities (not available separately)	<b>BAE</b>	2.50 Mbytes <sup>b</sup>
W-CDMA or W-CDMA w/ HSDPA measurement personality	<b>BAF, 210</b>	5.25 Mbytes <sup>b</sup>
cdma2000 or cdma2000 w/ 1xEV-DV measurement personality	<b>B78, 214</b>	4.14 Mbytes <sup>b</sup>
1xEV-DO measurement personality	<b>204</b>	4.95 Mbytes <sup>b</sup>
GSM (with EDGE) measurement personality	<b>202</b>	3.42 Mbytes <sup>b</sup>
Shared measurement library <sup>b</sup>	n/a	5.68 Mbytes
<b>PSA only Options:</b>		
Phase noise measurement personality	<b>226</b>	2.93 Mbytes <sup>c</sup>
Noise Figure measurement personality	<b>219</b>	4.87 Mbytes <sup>c</sup>
Basic measurement personality with digital demod hardware	<b>B7J</b>	Cannot be deleted
HP8566B/HP8568B Programming Code Compatibility <sup>d</sup>	<b>266</b>	1.08 Mbytes <sup>c</sup>
TD-SCDMA	<b>211</b>	5.27 Mbytes <sup>c</sup>
Flexible Digital Modulation Analysis	<b>241</b>	1.93 Mbytes
Shared measurement library <sup>b</sup>	n/a	5.68 Mbytes
<b>E4406A only Options:</b>		
GSM measurement personality	<b>BAH</b>	3.42 Mbytes <sup>b</sup>
EDGE upgrade from BAH measurement personality	<b>252</b>	3.42 Mbytes <sup>b</sup>
iDEN measurement personality	<b>HN1</b>	1.80 Mbytes <sup>b</sup>
Baseband I/Q Inputs	<b>B7C</b>	n/a (hardware only)

a. Available as of the print date of this guide.

b. Many PSA Series and VSA E4406A personality options use a 5.68 MByte shared measurement library. If you are loading multiple personalities that use this library, you only need to add this memory allocation once.

- c. Shared measurement library allocation not required
- d. This is a no charge option that does not require a license key.

### Memory Upgrade Kits

The PSA 64 MByte Memory Upgrade kit p/n is E4440AU Option ANE.  
The VSA 64 MByte Memory Upgrade kit p/n is E4406AU Option ANE.

For more information about memory upgrade kits contact your local sales/service office, or see:

<http://www.agilent.com/find/saupgrades>

### Loading an Optional Measurement Personality

You must use a PC to load the desired personality option into the instrument memory. Loading can be done from a firmware CD-ROM or an internet location. An automatic loading program comes with the files and runs from your PC.

You can check the Agilent internet website for the latest firmware versions available for downloading:

For PSA, see [http://www.agilent.com/find/psa\\_firmware](http://www.agilent.com/find/psa_firmware)

For VSA, see [http://www.agilent.com/find/vsa\\_firmware](http://www.agilent.com/find/vsa_firmware)

---

**NOTE**

When you add a new option, or update an existing option, you will get the updated versions of all your current options as they are all reloaded simultaneously. This process may also require you to update the instrument core firmware so that it is compatible with the new option.

Depending on your installed hardware memory, you may not be able to fit all of the available measurement personalities in instrument memory at the same time. You may need to delete an existing option file from memory and load the one you want. Use the automatic update program that is provided with the files. Refer to the table showing “[Measurement Personality Options and Memory Required](#)” on page 38.

The approximate memory requirements for the options are listed above. These numbers are worst case examples. Some options share components and libraries, therefore the total memory usage of multiple options may not be exactly equal to the combined total.

### Obtaining and Installing a License Key

If you purchase an optional personality that requires installation, you will receive an “Entitlement Certificate” which may be redeemed for a license key specific to one instrument. Follow the instructions that accompany the certificate to obtain your license key.

To install a license key number for the selected personality option, use

the following procedure:

---

**NOTE**

---

You can also use this procedure to reinstall a license key number that has been deleted during an uninstall process, or lost due to a memory failure.

For PSA:

1. Press **System, More, More, Licensing, Option** to access the alpha editor. Use this alpha editor to enter letters (upper-case), and the front-panel numeric keys to enter numbers for the option designation. You will validate your option entry in the active function area of the display. Then, press the **Enter** key.
2. Press **License Key** to enter the letters and digits of your license key. You will validate your license key entry in the active function area of the display. Then, press the **Enter** key.
3. Press the **Activate License** key.

For E4406A:

1. Press **System, More, More, Install, Choose Option** to access the alpha editor. Use this alpha editor to enter letters (upper-case), and the front-panel numeric keys to enter numbers for the option designation. You will validate your option entry in the active function area of the display. Then, press the **Done** key.

---

**NOTE**

---

Before you enter the license key for the EDGE Retrofit Option 252, you must already have entered the license key for the GSM Option BAH.

2. Press **License Key** to enter the letters and digits of your license key. You will validate your license key entry in the active function area of the display. Then, press the **Done** key.
3. Press the **Install Now** key. The message “New option keys become active after reboot.” will appear, along with the **Yes/No** menu: press the **Yes** key and cycle the instrument power off and then on to complete your installation process, or press the **No** key to cancel the installation process.



## Viewing a License Key

Measurement personalities purchased with your instrument have been installed and activated at the factory before shipment. The instrument requires a **License Key** unique to every measurement personality purchased. The license key number is a hexadecimal number specific to your measurement personality, instrument serial number and host ID. It enables you to install, or reactivate that particular personality.

Use the following procedure to display the license key number unique to your personality option that is already installed in your instrument:

For PSA:

Press **System, More, More, Licensing, Show License**. The **System, Personality** key displays the personalities loaded, version information, and whether the personality are licensed.

For E4406A:

Press **System, More, More, Install, Choose Option** to enter the letters/numbers for the option you want. You can see the key on the **License Key** softkey. Press the Done key.

---

### NOTE

*You will want to keep a copy of your license key number in a secure location. Press **System, More**, then **Licensing, Show License** for PSA, or **Show System** for E4406A, and print out a copy of the display that shows the license numbers. If you should lose your license key number, call your nearest Agilent Technologies service or sales office for assistance.*

---

## Using the Delete License Key (PSA Only)

This key will make the option unavailable for use, but will not delete it from memory. Write down the 12-digit license key number for the option before you delete it. If you want to use that measurement personality later, you will need the license key number to reactivate the personality firmware.

---

### NOTE

Using the **Delete License** key does not remove the personality from the instrument memory, and does not free memory to be available to install another option. If you need to free memory to install another option, refer to the instructions for loading firmware updates located at the URL: <http://www.agilent.com/find/psa/>

---

1. Press **System, More, More, Licensing, Option**. Pressing the **Option** key will activate the alpha editor menu. Use the alpha editor to enter the letters (upper-case) and the front-panel numeric keyboard to enter the digits (if required) for the option, then press the **Enter** key. As you enter the option, you will see your entry in the active function area of the display.
2. Press **Delete License** to remove the license key from memory.

## Using the Uninstall Key (E4406A Only)

This key will make the option unavailable for use, but will not delete it from memory. The message “Application Not Licensed” will appear in the Status/Info bar at the bottom of the display. Record the 12-digit license key number for the option before you delete it. If you want to use that measurement personality later, you will need the license key number to reactivate the personality firmware.

---

### NOTE

Using the **Uninstall** key does not remove the personality firmware from the instrument memory, and does not free memory to be available to install another option. If you need to free memory to install another option, refer to the instructions for loading firmware updates available at the URL: <http://www.agilent.com/find/vsa/>

1. Press **System, More(1 of 3), More(2 of 3), Uninstall, Choose Option** to access the alpha editor. Use this alpha editor to enter the letters (upper-case), and the front-panel numeric keys to enter the numbers (if required) for the installed option. You will validate your option entry in the active function area of the display. Then, press the **Done** key.
2. Pressing the **Uninstall Now** key will activate the **Yes/No** menu: press the **Yes** key to continue your uninstall process, or press the **No** key to cancel the uninstall process.
3. Cycle the instrument power off and then on to complete the uninstall process.

## Performing a Security Erase on PSA Series Spectrum Analyzers

A Security Erase of a PSA can perform the following functions:

- Blank the display
- Erase user files
- Erase all memory including the operating system

To perform a security erase of your instrument memory you will need to have PSA Option HS7, a free firmware option, installed. For more information see:

<http://www.agilent.com/find/security>

Instructions for security erase procedures and the PSA Option HS7 firmware upgrade are available for downloading.

---

### CAUTION

Security Erase procedures can leave your instrument in an inoperative state. Be sure to follow the instructions carefully.

## Ordering Optional Measurement Personalities

To order a measurement personality option you need to supply the instrument model number, the host ID and the serial number.

<b>Required Information:</b>	<b>Front Panel Key Path:</b>
Model #: (Ex. E4406A)	
Host ID: _____	<b>System, Show System</b>
Instrument Serial Number: _____	<b>System, Show System</b>



---

---

## 2

# Making Measurements

This chapter describes procedures used for making measurements of GSM and EDGE BTS or MS. Instructions to help you set up and perform the measurements are provided, and examples of GSM and EDGE measurement results are shown.

---

## GSM and EDGE Measurements

The following measurements for the GSM 450, GSM 480, GSM 700, GSM 850, GSM 900, DCS 1800, and PCS 1900 bands are available by pressing the **Measure** key (except for the Tx Band Spurs and EDGE Tx Band Spurs measurements, which support P-GSM, E-GSM, R-GSM, DCS 1800, and PCS 1900 only):

These are referred to as one-button measurements. When you press the key to select the measurement it will become the active measurement, using settings and a display unique to that measurement. Data acquisitions will automatically begin provided trigger requirements, if any, are met.

**Transmit Power** – This test verifies in-channel power for GSM and EDGE systems. Good measurement results ensure that dynamic power control is optimized, over all system interference is minimized, and mobile station battery life is maximized. See [“Transmit Power Measurements” on page 113](#)

**Power vs. Time** – Verifies that the transmitter output power has the correct amplitude, shape, and timing for the GSM or EDGE format. GMSK and EDGE versions of this measurement are available. See [“GMSK Power vs. Time \(PvT\) Measurements” on page 92](#) and [“EDGE Power vs. Time \(PVT\) Measurements” on page 50](#).

**Output RF Spectrum (ORFS)** – Verifies that the modulation, wideband noise, and power level switching spectra are within limits and do not produce significant interference in the adjacent base transceiver station (BTS) channels. GMSK and EDGE versions of this measurement are available. See [“GMSK Output RF Spectrum \(ORFS\) Measurements” on page 75](#) and [“EDGE Output RF Spectrum \(ORFS\) Measurements” on page 60](#).

**Tx Band Spur** – Verifies that the transmitter does not transmit undesirable energy into the transmit band. This energy may cause interference for other users of the GSM system. GMSK and EDGE versions of this measurement are available. See [“GMSK Transmitter Band Spurious Signal \(Tx Band Spur\) Measurements” on page 99](#) and [“EDGE Tx Band Spur Measurements” on page 72](#).

**Phase and Frequency** – Verifies modulation quality of the 0.3 GMSK signal for GSM systems. The modulation quality indicates the carrier to noise performance of the system, which is critical for mobiles with low signal levels, at the edge of a cell, or under difficult fading or Doppler conditions. See [“GMSK Phase and Frequency Error Measurements” on page 87](#).

**Error Vector Magnitude (EVM)** – Provides a measure of

modulation accuracy. The EDGE 8 PSK modulation pattern uses a rotation of  $3\pi/8$  radians to avoid zero crossing, thus providing a margin of linearity relief for amplifier performance. This is an EDGE only measurement. See [“EDGE Error Vector Magnitude \(EVM\) Measurements” on page 56](#).

**Spectrum** – Provides spectrum analysis capability similar to a swept tuned analyzer. The spectrum measurement is FFT (Fast Fourier Transform) based. See [“Spectrum \(Frequency Domain\) Measurements” on page 102](#).

**Waveform** – Enables you to view waveforms in the time domain. This measurement provides fast zero span functionality which is a crucial feature of traditional spectrum analyzers. See [“Waveform \(Time Domain\) Measurements” on page 117](#).

For E4406A, Baseband I/Q Inputs, Option B7C, is available for use with these measurements. For details see [“Using Option B7C Baseband I/Q Inputs” on page 127](#).

## Setting up and Making a Measurement

### Making the Initial Signal Connection

---

**CAUTION**

Before connecting a signal to the instrument, make sure the instrument can safely accept the signal level provided. The signal level limits are marked next to the connectors on the front panel.

See “[Input/Output Key Menu](#)” on page 148 for details on selecting input ports and setting internal attenuation to prevent overloading the instrument.

For PSA only, the “[Input/Output Key Menu](#)” on page 148 also provides details of **Int Preamp** operation.

### Using Instrument Mode and Measurement Presets

If you want to set your current measurement personality to a known, factory default state, press **Preset**. This initializes the instrument by returning the mode setup and all of the measurement setups in the mode to the factory default parameters.

---

**NOTE**

For PSA, note that pressing the **Preset** key will switch instrument modes unless the type of preset is selected under **System, Power On/Preset** is set to **Mode** or **Save User Preset**.

To preset only the parameters that are specific to an active, selected measurement, press **Meas Setup**, then **Restore Meas Defaults**. **Restore Meas Defaults** will return all the measurement setup parameters to the factory defaults, but only for the currently selected measurement. The **Restore Meas Defaults** key may not appear on the first page of the **Meas Setup** menu. If not, press **More** until the key is available.



## The 3 Steps to Set Up and Make Measurements

All measurements need to be set up in 3 steps: first at the Mode level, second at the Measurement level, then finally the result display may be adjusted.

### 1. Select and Set Up the Mode

Press **MODE** - All licensed, installed Modes available are shown.

Press **EDGE w/ GSM, GSM**, or select **Basic** mode to make measurements of signals with non-standard formats.

Press **Mode Setup** - Make any required adjustments to the mode settings. These settings apply to all measurement in the mode.

### 2. Select and Set Up the Measurement

Press **MEASURE** - Select a specific measurement to be performed (e.g. **ACP, Spectrum** or **Waveform**). The measurement begins as soon as any required trigger conditions are met. The resulting data is shown on the display or is available for export.

Press **Meas Setup** - Make any adjustments as required to the selected measurement settings. The settings only apply to this measurement.

### 3. Select and Set Up a View of the Results

Press **Trace/View** - Select a display format for the current measurement data. Depending on the mode and measurement selected, other graphical and tabular data presentations may be available. **X-Scale** and **Y-Scale** adjustments may also be made now.

---

**NOTE**

A setting may be reset at any time, and will be in effect on the next measurement cycle or View.

---

Step	Primary Key	Setup Keys	Related Keys
1. Select & set up a Mode	<b>MODE</b>	<b>Mode Setup, Input (E4406A), Input/Output (PSA), FREQUENCY Channel</b>	<b>System</b>
2. Select & set up a Measurement	<b>MEASURE</b>	<b>Meas Setup</b>	<b>Meas Control, Restart</b>
3. Select & set up a View of the Results	<b>View/Trace (E4406A), Trace/View (PSA)</b>	<b>SPAN X Scale, AMPLITUDE Y Scale, Display, Next Window, Zoom</b>	<b>File, Save, Print, Print Setup, Marker, Search (E4406A), Peak Search (PSA)</b>

## EDGE Power vs. Time (PvT) Measurements

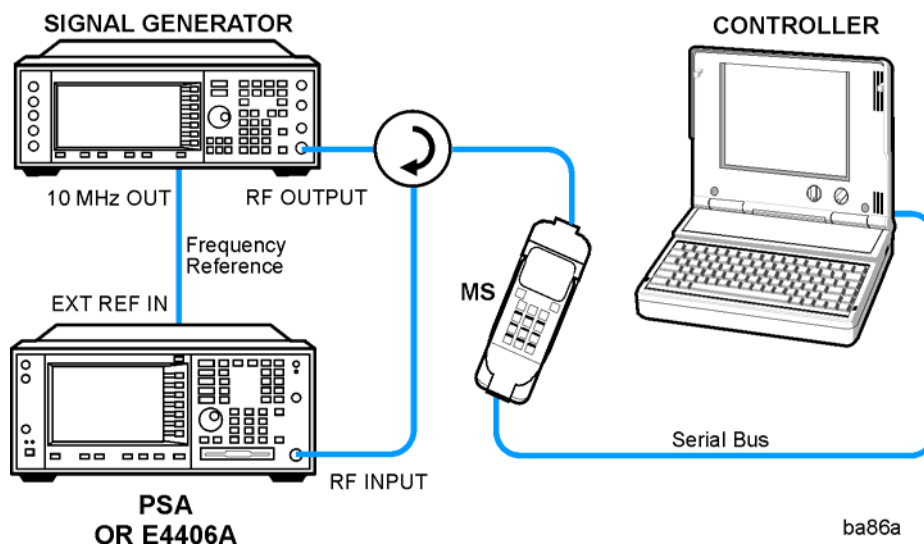
This section explains how to make an EDGE Power versus Time (PvT) measurement on an EDGE mobile station. Good PvT measurement results verify that the transmitter output power has the correct amplitude, shape, and timing for the EDGE format.

**NOTE** This measurement is designed for EDGE. For the GSM PvT measurement see “GMSK Power vs. Time (PvT) Measurements” on page 92.

### Configuring the Measurement System

This example shows a mobile station (MS) under test set up to transmit RF power, and being controlled remotely by a system controller. The transmitting signal is connected to the analyzer RF input port. Connect the equipment as shown.

**Figure 2-1** EDGE Pwr vs Time Measurement System



1. Using the appropriate cables, adapters, and circulator, connect the output signal of the MS to the RF input of the instrument.
2. Connect the base transmission station simulator or signal generator to the MS through a circulator to initiate a link constructed with sync and pilot channels, if required.
3. Connect a BNC cable between the 10 MHz OUT port of the signal generator and the EXT REF IN port of the instrument.
4. Connect the system controller to the MS through the serial bus cable to control the MS operation.

## Setting the MS (Example)

From the base transmission station simulator and the system controller, set up a call using loopback mode for the MS to transmit the RF power as follows:

MS:                    Symbol Rate: 270.833kbps  
Frequency:        935.2000 MHz (ARFCN number 1)  
Output Power:    -3 dBW (0.5 W)

## Measurement Procedure

- Step 1.** Press the **Preset** key to preset the instrument.
- Step 2.** Press the **MODE, GSM (w/EDGE)** keys to enable the GSM with EDGE mode measurements.
- Step 3.** Press the **Mode Setup, Trigger** keys to select a trigger source as described in the section titled [“EDGE Power vs. Time Measurement Keys” on page 173](#).
- Step 4.** Press the **Radio, Band** keys to select the desired band. This will determine the frequency and band-related presets. Our example will use the default setting, **P-GSM**.
- Step 5.** Press the **Radio, Device** keys to toggle the device to **MS**.
- Step 6.** Press the **FREQUENCY Channel** key to select the desired center frequency or ARFCN as described in the section titled [“FREQUENCY Channel Key Menu” on page 139](#).
- Step 7.** Press the **Burst Type** key to select the desired burst type as described in the section titled [“FREQUENCY Channel Key Menu” on page 139](#).
- Step 8.** If your signal of interest contains more than 1 Training Sequence, press the **TSC** key, and select a standard Training Sequence (numbered 0-7) to which the measurement will synchronize. The default setting for **TSC** is **Auto**, which will automatically correlate to any one of the standard Training Sequences numbered 0-7. See [“FREQUENCY Channel Key Menu” on page 139](#).
- Step 9.** Press the **MEASURE, EDGE Pwr vs Time** keys to initiate the EDGE Power vs Time measurement.
- Step 10.** Press the **Meas Setup, More, Pwr Ctrl Lvl** keys to select the desired power control level. Our example will use the default setting **0**.

For more details about changing measurement parameters, see [“EDGE Power vs. Time Measurement Concepts” on page 530](#)

If you have a problem, and get an error message, see [“Interpreting Error Codes” on page 133](#).

## Results

The views available under the **View/Trace** menu are **Burst**, **Rise & Fall**, and **Multi-Slot**. For more information see “[EDGE Power vs. Time Measurement Keys](#)” on page 173.

Information shown in the left margin of the displays include:

- **MaxP** - This is total input power allowed for the measurement. This value is coupled to the internal RF **Input Atten** setting.
- **ExtAt** - This value reflects the **External RF Atten** setting.
- **Sync** - The **Burst Sync** setting used in the current measurement
- **Trig** - The **Trigger Source** setting used in the current measurement

The **Mean Transmit Power** is displayed at the bottom left of the Burst and Rise & Fall views:

- **Mean Transmit Power** - This is the RMS average power across the “useful” part of the burst, or the 147 bits centered on the transition from bit 13 to bit 14 (the “T0” time point) of the 26 bit training sequence. An RMS calculation is performed and displayed regardless of the averaging mode selected for the trace data.

If Averaging = ON, the result displayed is the RMS average power of all bursts measured. If Averaging = OFF, the result is the RMS average power of the single burst measured. This is a different measurement result from Mean Transmit Pwr, below.

The **Current Data** displayed at the bottom of the Burst and Rise & Fall views include:

- **Mean Transmit Pwr** - This result appears only if Averaging = ON. It is the RMS average of power across the “useful” part of the burst, for the current burst only. If a single measurement of “n” averages has been completed, the result will indicate the Mean Transmit Pwr of the last burst. The RMS calculation is performed and displayed regardless of the averaging mode selected for the trace data. This is a different measurement result from Mean Transmit Power, above.
- **Max Pt.** - Maximum signal power point in dBm
- **Min Pt.** - Minimum signal power point in dBm
- **Burst Width** - Time duration of burst at -3 dB power point (half-power)
- **Mask Ref Pwr Midamble** - The Mask Reference Power is the average power in dBm of the middle 16 symbols in the midamble. The times displayed are the corresponding start and stop times of the middle 16 symbols.
- **1st Error Pt** - (Error Point) The time (displayed in ms or  $\mu$ s)

indicates the point on the X Scale where the first failure of a signal was detected. Use a marker to locate this point in order to examine the nature of the failure.

The table in the lower portion of the multi-slot view shows the output power in dBm for each timeslot, as determined by the integer (1 to 8) entered in the **Meas Setup, Meas Time** setting. Output power levels are presented for the active slots; a dashed line will appear for any slot that is inactive. The timeslot that contains the burst of interest is highlighted in blue.

**Figure 2-2** EDGE Power vs. Time Result - Burst View

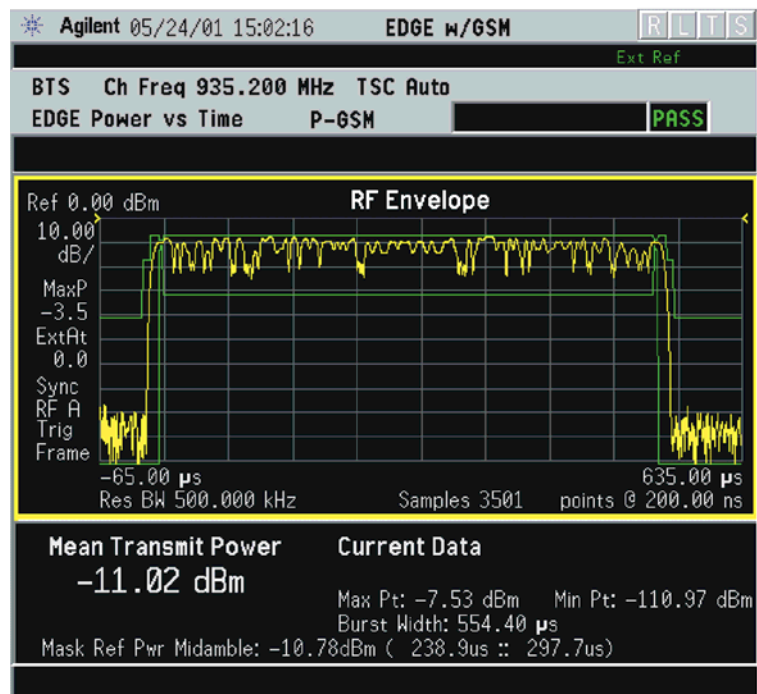


Figure 2-3

EDGE Power vs. Time Result - Rise & Fall View

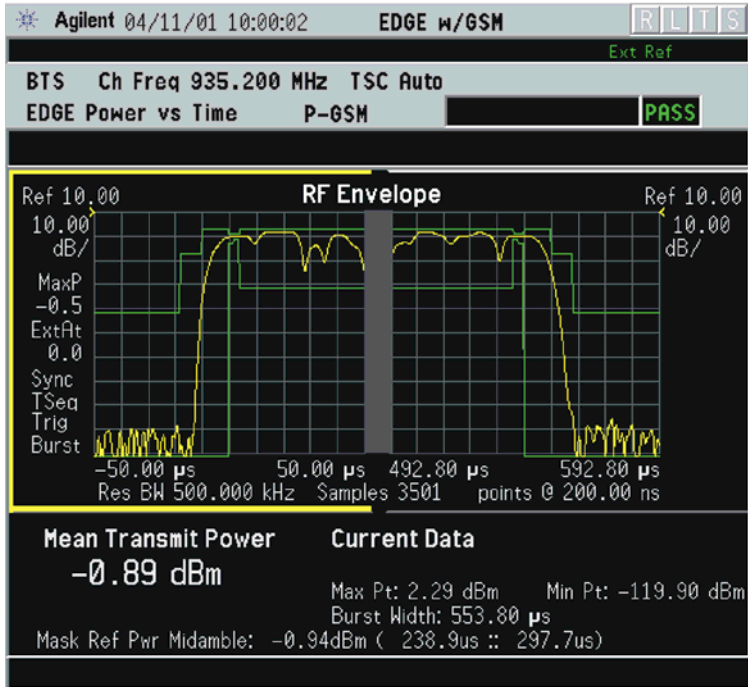
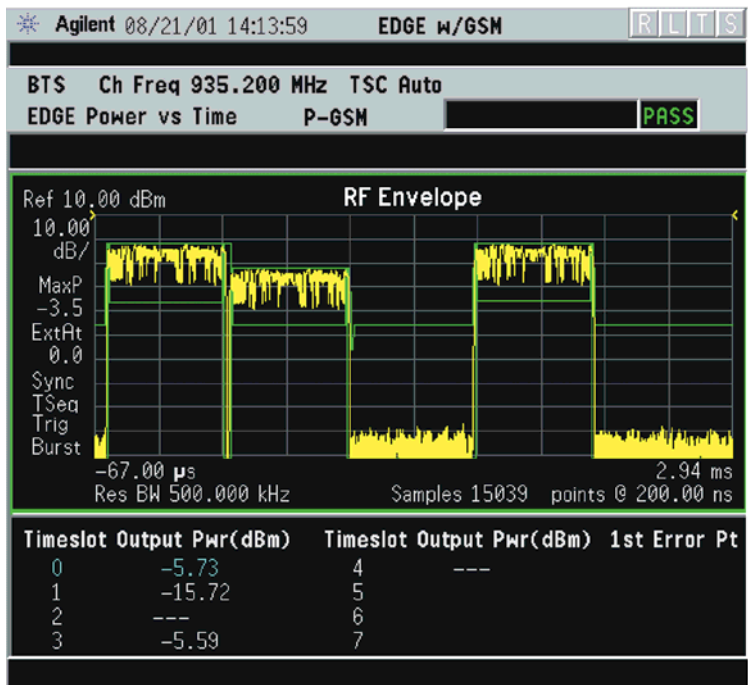
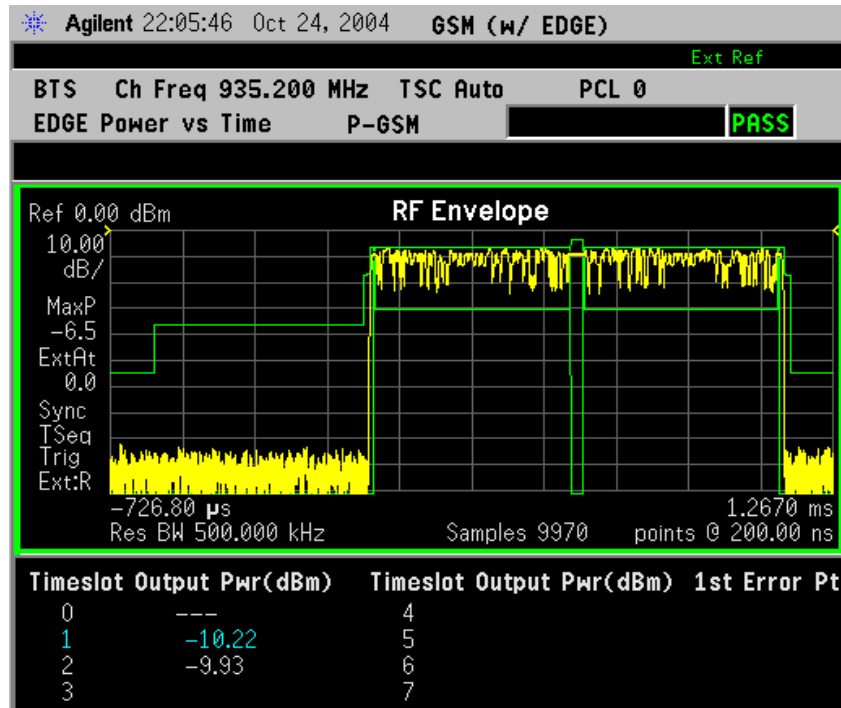


Figure 2-4

EDGE Result - Multi-Slot View



**Figure 2-5** EDGE PVT Result - Custom Limit Mask Example of Two Consecutive Bursts



For more information on making measurements of two consecutive bursts, including the SCPI commands used to make the measurement, refer to the section in the Programming Commands chapter. See “EDGE PVT Custom Limit Mask Example of Two Consecutive Bursts” on page 413.

### Troubleshooting Hints

If a transmitter fails the EDGE Power vs. Time measurement this usually indicates a problem with the units output amplifier or leveling loop.

## EDGE Error Vector Magnitude (EVM) Measurements

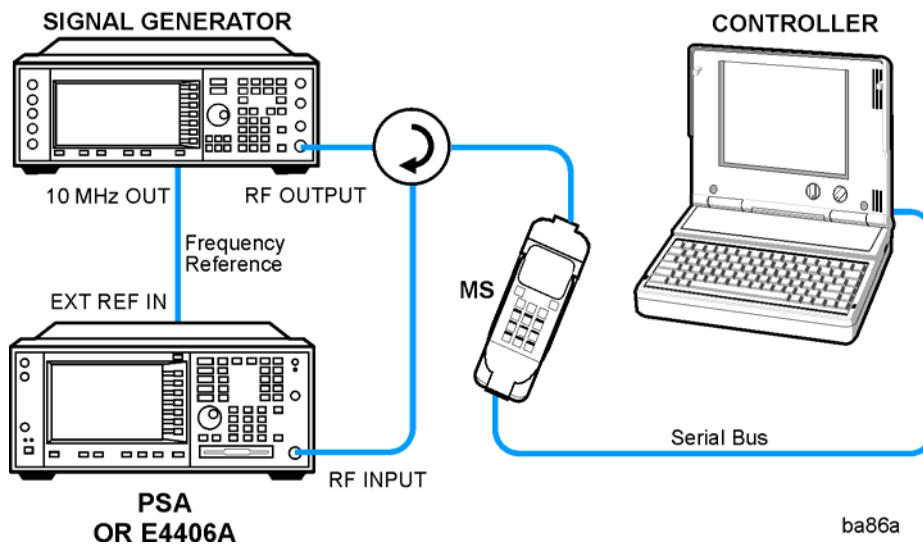
This section explains how to make an EDGE Error Vector Magnitude (EVM) measurement on an EDGE mobile station. EVM provides a measure of modulation accuracy. The EDGE 8 PSK modulation pattern uses a rotation of  $3\pi/8$  radians to avoid zero crossing, thus providing a margin of linearity relief for amplifier performance.

**NOTE** This is an EDGE only measurement.

### Configuring the Measurement System

This example shows a mobile station (MS) under test set up to transmit RF power, and being controlled remotely by a system controller. The transmitting signal is connected to the analyzer RF input port. Connect the equipment as shown.

**Figure 2-6** EDGE EVM Measurement System



1. Using the appropriate cables, adapters, and circulator, connect the output signal of the MS to the RF input of the instrument.
2. Connect the base transmission station simulator or signal generator to the MS through a circulator to initiate a link constructed with sync and pilot channels, if required.
3. Connect a BNC cable between the 10 MHz OUT port of the signal generator and the EXT REF IN port of the instrument.
4. Connect the system controller to the MS through the serial bus cable to control the MS operation.



## Setting the MS (Example)

From the base transmission station simulator and the system controller, set up a call using loopback mode for the MS to transmit the RF power as follows:

MS:                   Symbol Rate: 270.833kbps  
Frequency:        935.2000 MHz (ARFCN number 1)  
Output Power:    -3 dBW (0.5 W)

## Measurement Procedure

- Step 1.** Press the **Preset** key to preset the instrument.
- Step 2.** Press the **MODE, GSM (w/EDGE)** keys to enable the GSM with EDGE mode measurements.
- Step 3.** Press the **Mode Setup, Trigger** keys to select a trigger source as described in the section titled [“EDGE EVM \(Error Vector Magnitude\) Measurement Keys”](#) on page 152.
- Step 4.** Press the **Radio, Device** keys to toggle the device to **MS**.
- Step 5.** Press the **FREQUENCY Channel** key to select the desired center frequency or ARFCN as described in the section titled [“FREQUENCY Channel Key Menu”](#) on page 139.
- Step 6.** Press the **Burst Type** key to select the desired burst type as described in the section titled [“FREQUENCY Channel Key Menu”](#) on page 139.
- Step 7.** If your signal of interest contains more than 1 Training Sequence, press the **TSC** key, and select a standard Training Sequence (numbered 0-9) to which the measurement will synchronize. The default setting for **TSC** is **Auto**, which will automatically correlate to any one of the standard Training Sequences numbered 0-9. See [“FREQUENCY Channel Key Menu”](#) on page 139.
- Step 8.** Press the **MEASURE, EDGE EVM** keys to initiate the EDGE Error Vector Magnitude measurement.

For more details about changing measurement parameters, see [“EDGE EVM Measurement Concepts”](#) on page 532

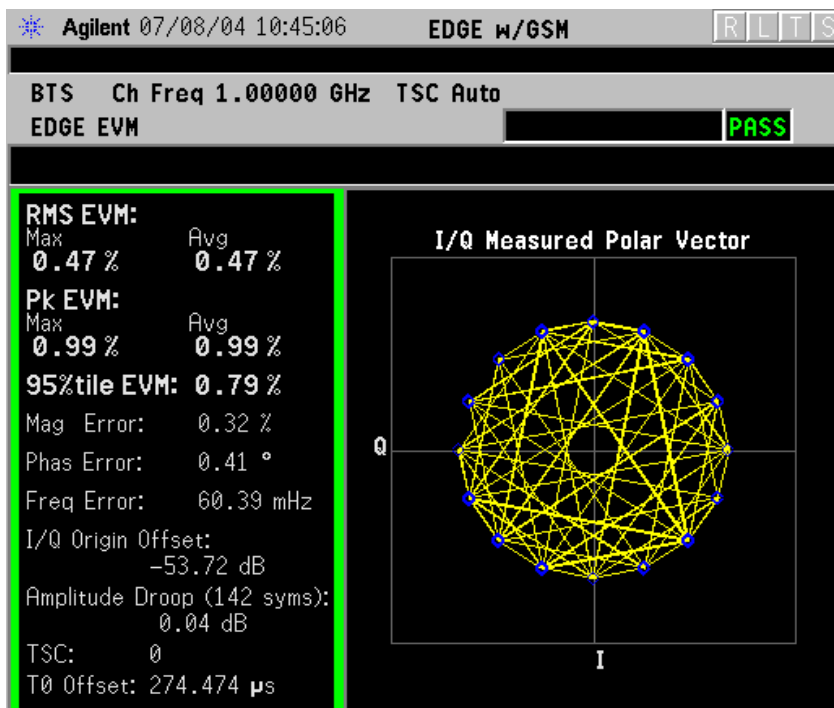
If you have a problem, and get an error message, see [“Interpreting Error Codes”](#) on page 133.

## Results

The next figure shows an example of measurement result with the graphic and text windows. The measured summary data is shown in the left window and the dynamic vector trajectory of the I/Q demodulated signal is shown as a polar vector display in the right window.

Figure 2-7

### EDGE EVM Result - Polar Vector View



## Troubleshooting Hints

Use the spectrum (frequency domain) measurement to verify that the signal is present and approximately centered on the display.

The data used for testing can have a detrimental effect on the EVM results, causing erratic or falsely high EVM, especially in the case of sending all 0 bits with the Trigger Source set to RF Burst. In that unique situation, better results will be obtained using Free Run or Video triggers.

Poor EVM indicates a problem at the I/Q baseband generator, filters, and/or modulator in the transmitter circuitry. The output amplifier in the transmitter can also create distortion that causes unacceptably high EVM. In a real system, poor EVM will reduce the ability of a receiver to correctly demodulate the signal, especially in marginal signal conditions. Poor EVM may also indicate that a measurement restart was not performed after the signal level was changed. Press **Restart** after a change in the input signal to ensure that an auto-attenuation adjustment is performed.

The I/Q Error Quad View display may be used to determine where demodulation errors are concentrated.

## EDGE Output RF Spectrum (ORFS) Measurements

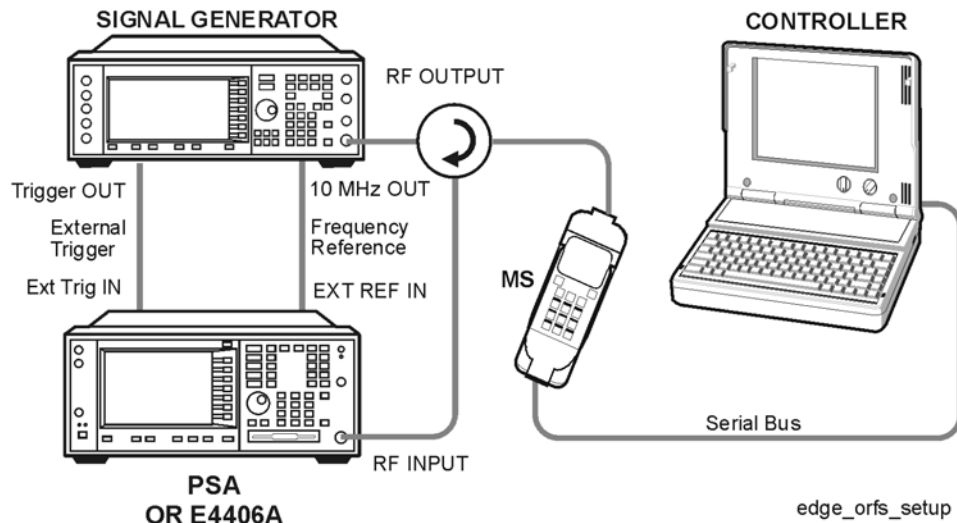
This section explains how to make an EDGE Output RF Spectrum measurement on an EDGE mobile station. This test verifies that the modulation, wideband noise, and power level switching spectra are within limits and do not produce significant interference in the adjacent base transceiver station (BTS) channels.

**NOTE** This measurement is designed for EDGE. For the GSM Output RF Spectrum measurement see “GMSK Output RF Spectrum (ORFS) Measurements” on page 75.

### Configuring the Measurement System

This example shows a mobile station (MS) under test set up to transmit RF power, and being controlled remotely by a system controller. The transmitting signal is connected to the analyzer RF input port. Connect the equipment as shown.

**Figure 2-8** EDGE ORFS Measurement System



1. Using the appropriate cables, adapters, and circulator, connect the output signal of the MS to the RF input of the instrument.
2. Connect the base transmission station simulator or signal generator to the MS through a circulator to initiate a link constructed with sync and pilot channels, if required.
3. Connect a BNC cable between the 10 MHz OUT port of the signal generator and the EXT REF IN port of the instrument.

4. Connect the system controller to the MS through the serial bus cable to control the MS operation.

---

**NOTE**

If the signal being measured has more than one active slot in a frame, the default RF Burst trigger must be changed, and an external event trigger must be provided to synchronize the frame. Otherwise the measurement may trigger randomly on any burst in an active slot. This is true for all ORFS time domain measurements.

---

### Setting the MS (Example)

From the base transmission station simulator and the system controller, set up a call using loopback mode for the MS to transmit the RF power as follows:

MS:                    Symbol Rate: 270.833kbps  
Frequency:        935.2000 MHz (ARFCN number 1)  
Output Power:    -30 dBm

### Measurement Procedure

- Step 1.** Press the **Preset** key to preset the instrument.
- Step 2.** Press the **MODE, GSM (w/EDGE)** keys to enable the EDGE mode measurements.
- Step 3.** Press the **Mode Setup, Trigger** keys to select a trigger source as described in the section titled [“EDGE Output RF Spectrum Measurement Keys” on page 162](#).
- Step 4.** Press the **Radio, Device** keys to toggle the device to **MS**.
- Step 5.** Press the **Demod, Burst Align** keys to toggle the burst alignment to **1/2 Bit Offset**.
- Step 6.** Press the **FREQUENCY Channel** key to select the desired center frequency or ARFCN as described in the section titled [“FREQUENCY Channel Key Menu” on page 139](#).
- Step 7.** Press the **Burst Type** key to select the desired burst type as described in the section titled [“FREQUENCY Channel Key Menu” on page 139](#).
- Step 8.** If your signal of interest contains more than 1 Training Sequence, press the **TSC** key, and select a standard Training Sequence (numbered 0-9) to which the measurement will synchronize. The default setting for **TSC** is **Auto**, which will automatically correlate to any one of the standard Training Sequences numbered 0-9. See [“FREQUENCY Channel Key Menu” on page 139](#).

**Step 9.** Press **Meas Setup** and select the **Meas Type** and **Meas Method** for your measurement:

- **Meas Type** - accesses a menu to choose the measurement that is optimized for the type of spectral distortion being investigated.
  - **Mod & Switch** - will perform both Modulation and Switching measurements, which measures the spectrum due to the 0.3 GMSK modulation and noise, and also measures Switching (transient) spectrum measurements.
  - **Modulation** - measures the spectrum optimized for distortion due to the 0.3 GMSK modulation and noise.
  - **Switching** - measures the spectrum optimized for distortion due to switching transients (burst ramping).
  - **Full Frame Modulation (FAST)**- improves measurement speed by acquiring a full frame of data prior to performing the FFT calculation. This feature can only be used when all slots in the transmitted frame are active. Use of an external trigger can enhance measurement speed when this feature is used. When **Full Frame Modulation (FAST)** is selected the current measurement defaults to the multi-offset measurement method; therefore the **Meas Method** key is grayed out and the **Single Offset** feature is not available.

- **Meas Method** - accesses a menu to choose the measurement mode.
  - **Multi-Offset** - automatically makes measurements at all offset frequencies in the selected list (**Standard**, **Short**, or **Custom**). (See table below.) Press the **Multi-Offset Freq List** key to select a list of offsets to measure.

**Multi-Offset** measurements may be made with either **Modulation** or **Switching** measurement types.

Offset measurement results are displayed as tabular data, and may be viewed as either absolute powers in the Modulation Power and Switching Power views, or as powers relative to the margins and limit settings in the Modulation Margin and Limit and Switching Margin and Limit views. See “[EDGE Output RF Spectrum Measurement Keys](#)” on page 162, and [Figure 2-9](#) on page 63.

- **Single Offset (Examine)** - makes a measurement at a single offset frequency as set by the **Single Offset Freq** softkey.

**Single Offset (Examine)** measurements may be made with either **Modulation** or **Switching** measurement types.

Single offset measurement results are displayed in a time domain plot, with the measurement offset shown as a gate by white vertical lines. See [Figure 2-13](#) on page 67.

- **Swept** - makes a measurement using time-gated spectrum analysis to sweep the analyzer with the gate turned on for the desired portion of the burst only, as set by the **Modulation Offs (offsets) & Limits** menu. The limits mask is applied to the spectrum plot, and the **Worst Frequency** parameters are displayed. This selection is only available if **Meas Type** is set to **Modulation**. See [Figure 2-16 on page 70](#).

**Step 10.** Press the **Restart** key to re-initiate an EDGE ORFS measurement if you change the **Meas Type** or **Meas Method**. You can also set **Meas Control** to **Measure Cont** for continuous measurements.

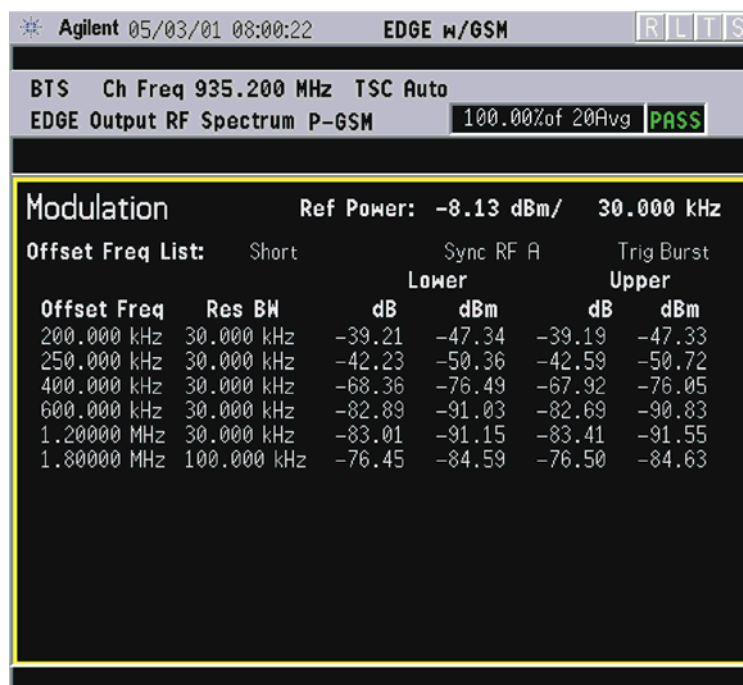
For more details about changing measurement parameters, see “[EDGE Output RF Spectrum Measurement Keys](#)” on page 162 and “[EDGE Output RF Spectrum Measurement Concepts](#)” on page 537

If you have a problem, and get an error message, see “[Interpreting Error Codes](#)” on page 133.

### EDGE ORFS Measurement Results

- **Modulation Power** - When **Meas Method** is set to **Multi-Offset**, and **Meas Type** is set to **Modulation**, or **Mod and Switch**, measurement results may be viewed as absolute powers in tabular form. The data will display offsets from any of the the **Multi-Offset Freq List** settings: **Standard**, **Short**, and **Custom**. The **Modulation Power** view is the default view for ORFS measurements. You can select the **Modulation Power** view by pressing **View/Trace**, then **Modulation Power**.

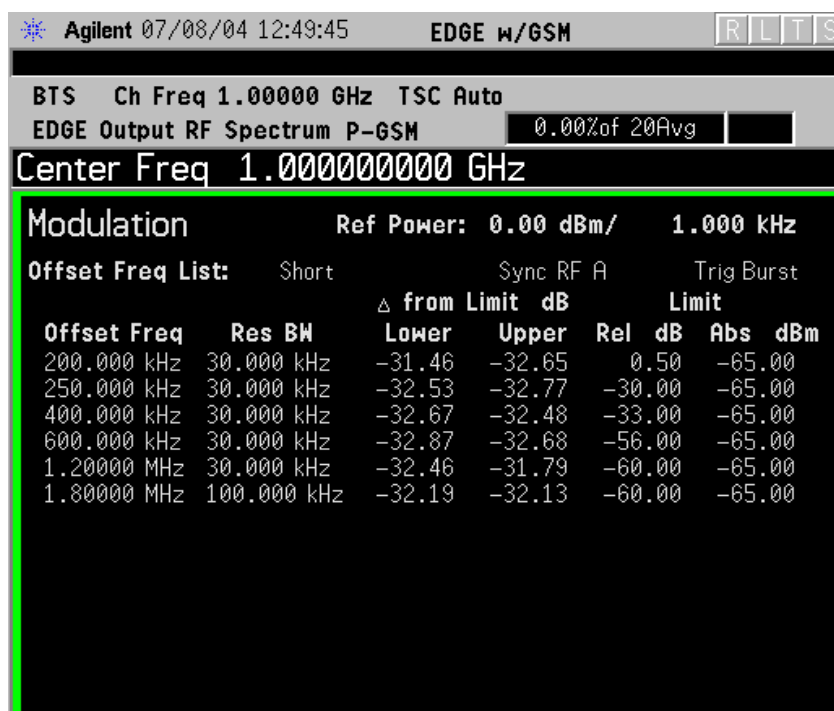
**Figure 2-9** EDGE ORFS - Example (Short List) Modulation Power View



- **Modulation Margin & Limits**- When **Meas Method** is set to **Multi-Offset**, and **Meas Type** is set to **Modulation**, or **Mod and Switch**, measurement results may be viewed as relative powers in tabular form. The data will display offsets from any of the the **Multi-Offset Freq List** settings: **Standard**, **Short**, and **Custom**, and shows the limit values selected by frequency, with the corresponding measurement result deltas.

You can select the **Modulation Margin and Limits** view by pressing **View/Trace**, then **Modulation Margin and Limits**.

**Figure 2-10** EDGE ORFS Result - Example (Short List) Modulation Margin & Limits View



For more details about changing measurement parameters, see “EDGE Output RF Spectrum Measurement Keys” on page 162 and “EDGE Output RF Spectrum Measurement Concepts” on page 537

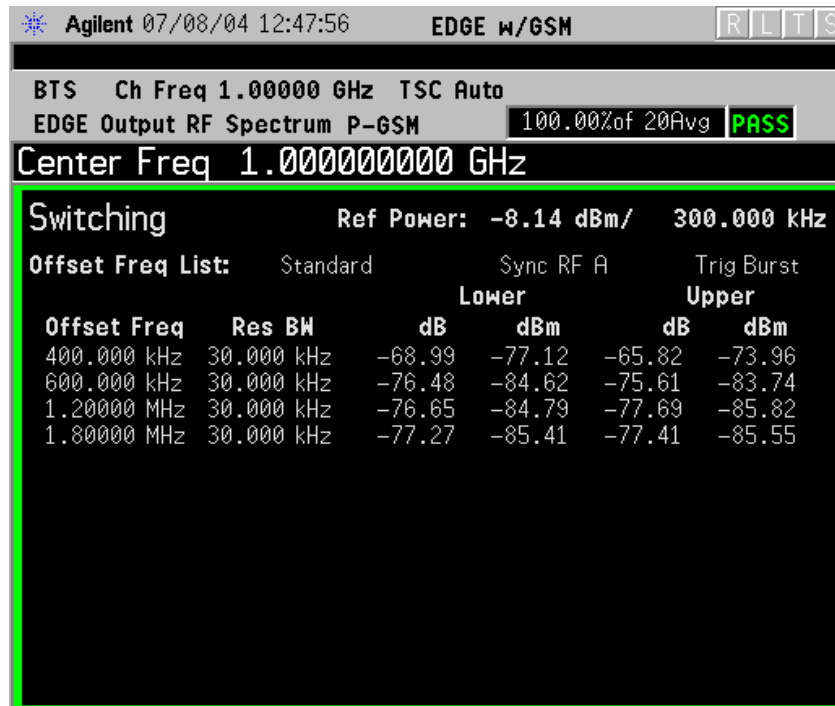
If you have a problem, and get an error message, see “Interpreting Error Codes” on page 133.



- **Switching Power** - When **Meas Method** is set to **Multi-Offset**, and **Meas Type** is set to **Switching**, or **Mod and Switch**, measurement results may be viewed as absolute powers in tabular form. The data will display offsets from any of the the **Multi-Offset Freq List** settings: **Standard**, **Short**, and **Custom**.

You can select the **Switching Power** view by pressing **View/Trace**, then **Switching Power**.

**Figure 2-11** EDGE ORFS Result - Example (Short List) Switching Power View



For more details about changing measurement parameters, see “EDGE Output RF Spectrum Measurement Keys” on page 162 and “EDGE Output RF Spectrum Measurement Concepts” on page 537

If you have a problem, and get an error message, see “Interpreting Error Codes” on page 133.

- **Switching Margin & Limits** - When **Meas Method** is set to **Multi-Offset**, and **Meas Type** is set to **Switching** or **Mod and Switch**, measurement results may be viewed as relative powers in tabular form. The data will display offsets from any of the the **Multi-Offset Freq List** settings: **Standard**, **Short**, and **Custom**, and shows the limit values selected by frequency, with the corresponding measurement result deltas.

You can select the **Switching Margin & Limits** view by pressing **View/Trace**, then **Switching Margin & Limits** .

**Figure 2-12** EDGE ORFS Result - Switching Margin & Limits View



For more details about changing measurement parameters, see “EDGE Output RF Spectrum Measurement Keys” on page 162 and “EDGE Output RF Spectrum Measurement Concepts” on page 537

If you have a problem, and get an error message, see “Interpreting Error Codes” on page 133.

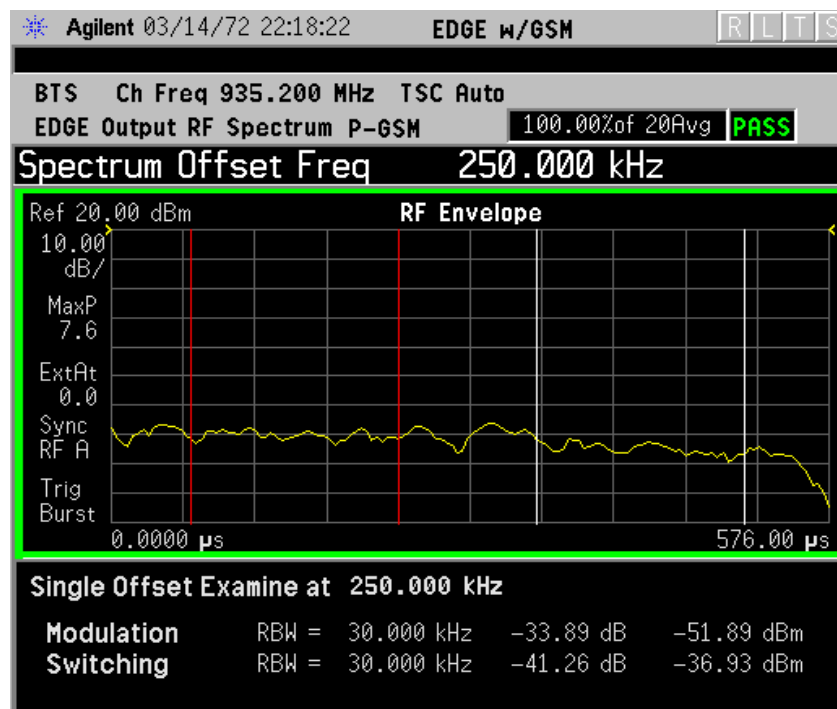
- **Single Offset (Examine)** - makes a measurement at a single offset frequency as set by the **Single Offset Freq** softkey.

Single offset measurement results are displayed as a power waveform in a time domain plot, with the measurement offset shown as a gate by white vertical lines. The red vertical lines represent the additional effective measurement window when **Fast Avg** is **ON** (default setting).

**NOTE**

The signal being displayed below is the useful part of slot 1, which in this example, is the only active slot in the frame. If any other slots are active, the default RF Burst trigger must be changed, and an external event trigger must be provided to synchronize the frame. Otherwise the measurement may trigger randomly on any burst in an active slot. This is true for all ORFS measurements.

**Figure 2-13 EDGE ORFS Result - Modulation Single Offset (Examine) View**

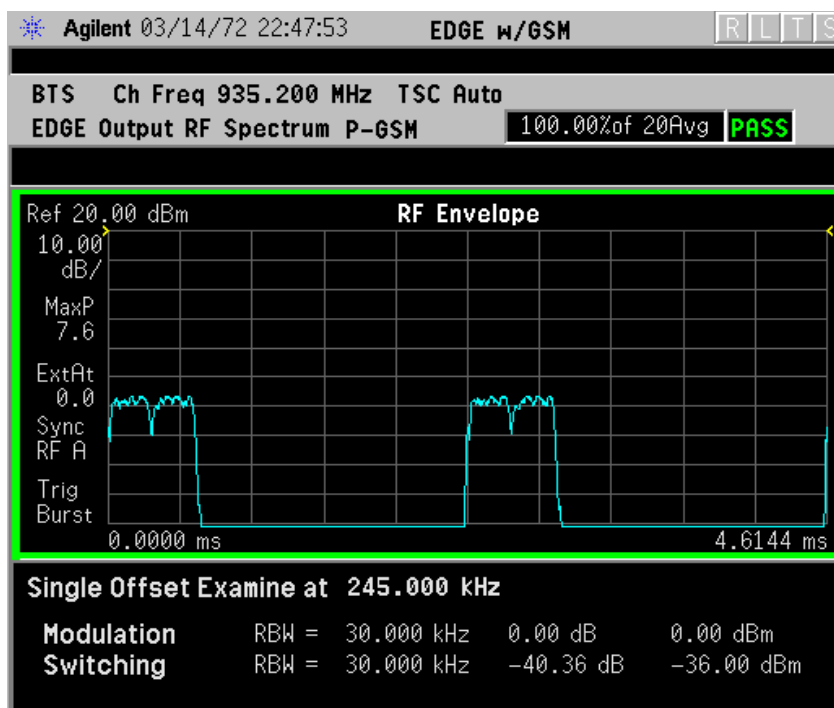


For more details about changing measurement parameters, see [“EDGE Output RF Spectrum Measurement Keys”](#) on page 162 and [“EDGE Output RF Spectrum Measurement Concepts”](#) on page 537

If you have a problem, and get an error message, see [“Interpreting Error Codes”](#) on page 133.

- Switching Single Offset measurement results are displayed in a time domain plot, but the waveform of the entire frame is displayed. In this example, slots 1 and 4 are active. Use the external trigger to maintain frame synchronization. **Fast Avg** is not available for this measurement.

**Figure 2-14 EDGE ORFS Result - Switching Single Offset (Examine) View**



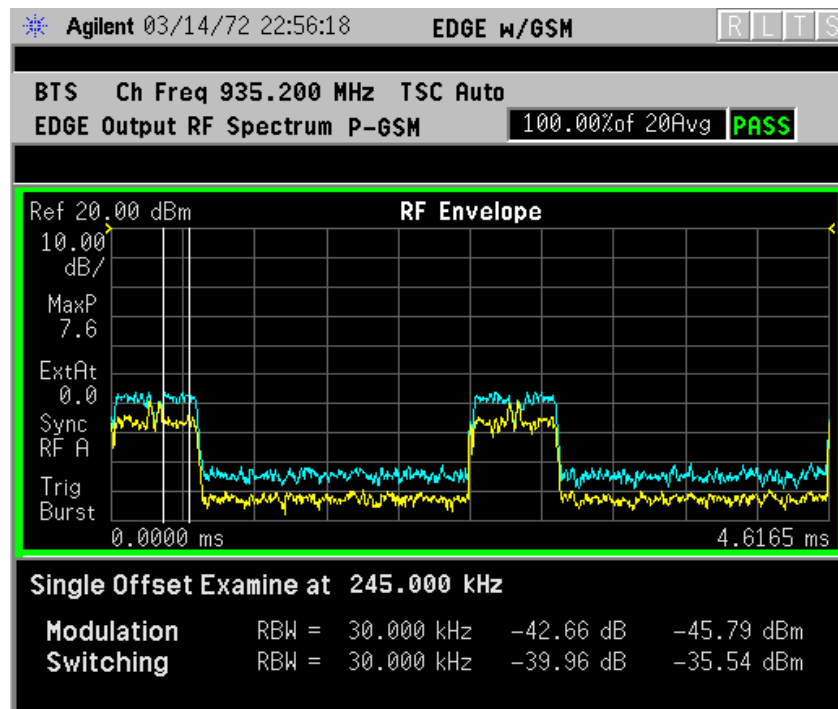
For more details about changing measurement parameters, see “EDGE Output RF Spectrum Measurement Keys” on page 162 and “EDGE Output RF Spectrum Measurement Concepts” on page 537

If you have a problem, and get an error message, see “Interpreting Error Codes” on page 133.

- Combination Modulation and Switching (**Mod & Switch**) Single Offset measurement results are displayed in a time domain plot, but the waveform of the entire frame is displayed. The blue trace is the Switching data and the yellow trace is the Modulation data, with the measurement gates shown.

In this example, slots 1 and 4 are active. Use the external trigger to maintain frame synchronization. **Fast Avg** is not available for this measurement.

**Figure 2-15 EDGE ORFS Result - Mod & Switch Single Offset (Examine) View**

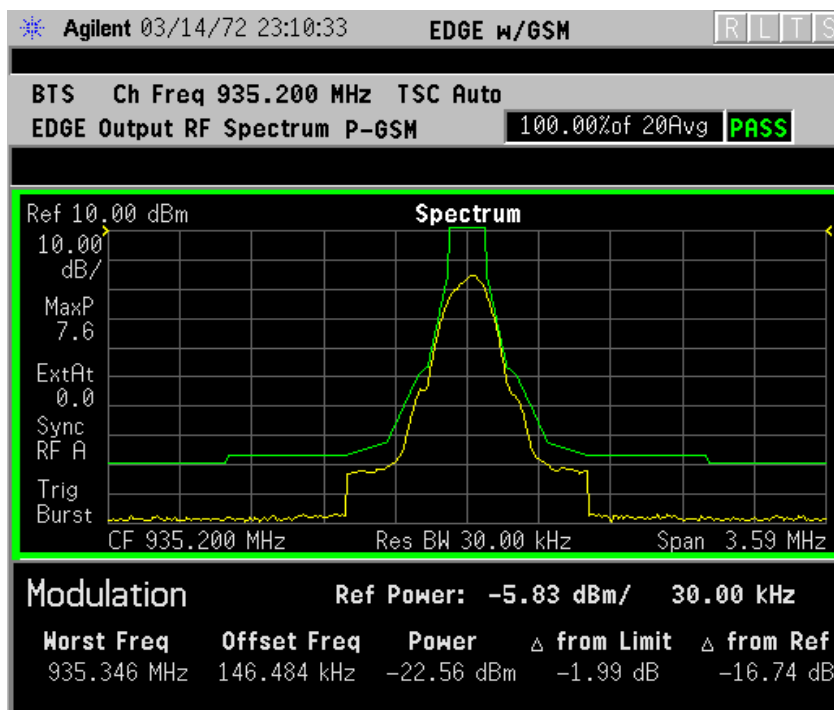


For more details about changing measurement parameters, see “EDGE Output RF Spectrum Measurement Keys” on page 162 and “EDGE Output RF Spectrum Measurement Concepts” on page 537

If you have a problem, and get an error message, see “Interpreting Error Codes” on page 133.

- **Swept** - When **Meas Type** is set to **Modulation** and **Meas Method** is set to **Swept**, measurement results may be viewed in the spectrum domain, with the limit mask applied to the spectrum plot, and the Worst Frequency parameters displayed. This selection is only available if **Meas Type** is set to **Modulation**.

**Figure 2-16** EDGE ORFS Result - Example Modulation Swept View



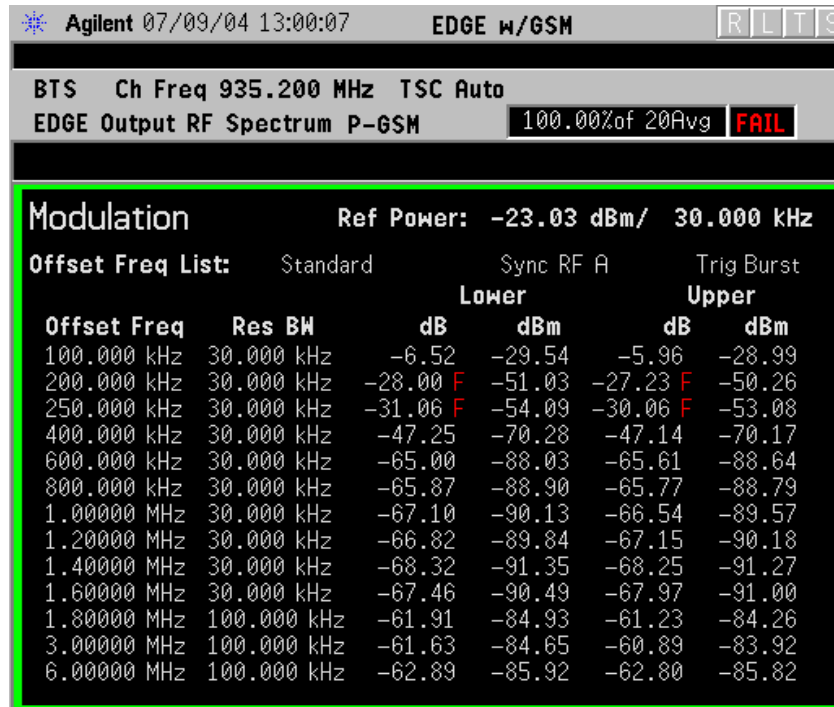
For more details about changing measurement parameters, see “EDGE Output RF Spectrum Measurement Keys” on page 162 and “EDGE Output RF Spectrum Measurement Concepts” on page 537

If you have a problem, and get an error message, see “Interpreting Error Codes” on page 133.

- **Full Frame Mode (FAST)** - When **Meas Method** is set to **Multi-Offset**, and **Meas Type** is set to **Full Frame Mode (FAST)**, measurement results may be viewed as relative and absolute powers in tabular form. The data will display offsets from any of the the **Multi-Offset Freq List** settings: **Standard**, **Short**, and **Custom**.

To measure **Full Frame Mode (FAST)** , all slots in the frame must be active. In the example below, slots 6 and 7 were inactive.

**Figure 2-17** EDGE ORFS Result - Full Frame Modulation (FAST) View



For more details about changing measurement parameters, see “EDGE Output RF Spectrum Measurement Keys” on page 162 and “EDGE Output RF Spectrum Measurement Concepts” on page 537

If you have a problem, and get an error message, see “Interpreting Error Codes” on page 133.

## EDGE Tx Band Spur Measurements

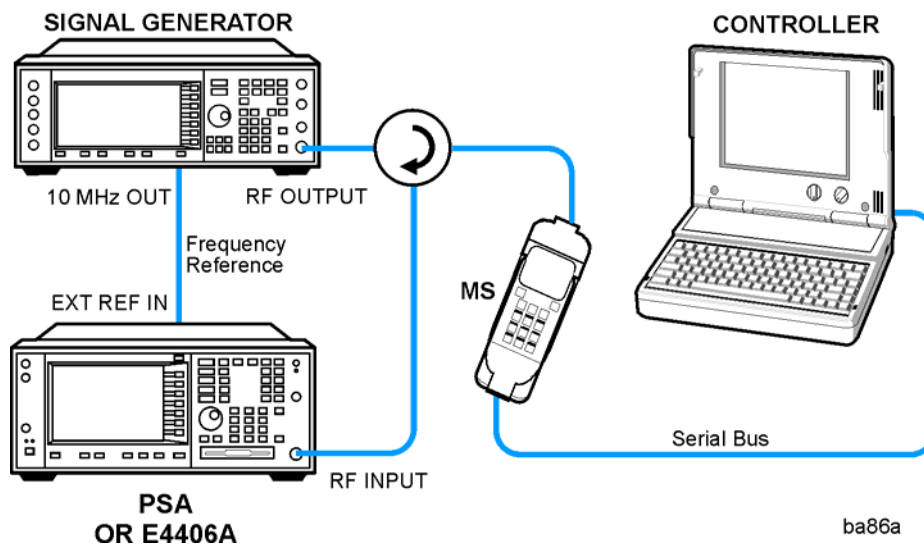
This section explains how to make an EDGE Tx Band Spur measurement on an EDGE mobile station. Good measurement results verify that the transmitter does not transmit undesirable energy into the transmit band. This energy may cause interference for other users of the EDGE system.

**NOTE** This measurement is designed for EDGE. For the GSM Output RF Spectrum measurement see “GMSK Output RF Spectrum (ORFS) Measurements” on page 75.

### Configuring the Measurement System

This example shows a mobile station (MS) under test set up to transmit RF power, and being controlled remotely by a system controller. The transmitting signal is connected to the analyzer RF input port. Connect the equipment as shown.

**Figure 2-18** EDGE Transmitter Band Spurious Measurement System



1. Using the appropriate cables, adapters, and circulator, connect the output signal of the MS to the RF input of the instrument.
2. Connect the base transmission station simulator or signal generator to the MS through a circulator to initiate a link constructed with sync and pilot channels, if required.
3. Connect a BNC cable between the 10 MHz OUT port of the signal generator and the EXT REF IN port of the instrument.
4. Connect the system controller to the MS.



## Setting the MS (Example)

From the base transmission station simulator and the system controller, set up a call using loopback mode for the MS to transmit the RF power as follows:

MS:                    Symbol Rate: 270.833kbps  
Frequency:        935.2000 MHz (ARFCN number 1)  
Output Power:    -3 dBW (0.5 W)

## Measurement Procedure

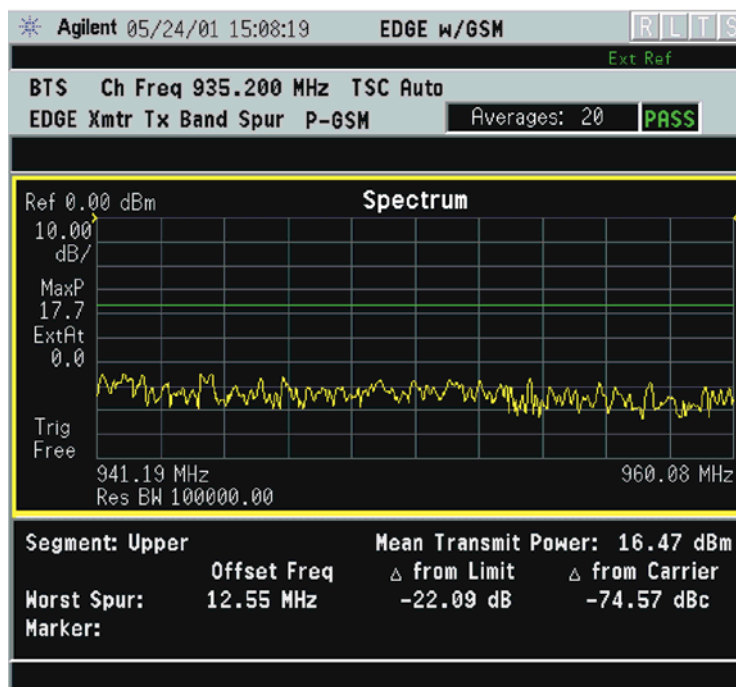
- Step 1.** Press the **Preset** key to preset the instrument.
- Step 2.** Press the **MODE, GSM (w/EDGE)** keys to enable the GSM with EDGE mode measurements.
- Step 3.** Press the **Mode Setup, Trigger** keys to select a trigger source as described in the section titled [“EDGE Tx Band Spur Measurement Keys” on page 181](#).
- Step 4.** Press the **Radio, Device** keys to toggle the device to **MS**.
- Step 5.** Press the **FREQUENCY Channel** key to select the desired center frequency or ARFCN as described in the section titled [“FREQUENCY Channel Key Menu” on page 139](#).
- Step 6.** Press the **Burst Type** key to select the desired burst type as described in the section titled [“FREQUENCY Channel Key Menu” on page 139](#).
- Step 7.** If your signal of interest contains more than 1 Training Sequence, press the **TSC** key, and select a standard Training Sequence (numbered 0-9) to which the measurement will synchronize. The default setting for **TSC** is **Auto**, which will automatically correlate to any one of the standard Training Sequences numbered 0-9. See [“FREQUENCY Channel Key Menu” on page 139](#).
- Step 8.** Press the **MEASURE, Tx Band Spur** keys to initiate the EDGE Transmitter Band Spurious products measurement.

For more details about changing measurement parameters, see [“EDGE Tx Band Spur Measurement Concepts” on page 542](#)

If you have a problem, and get an error message, see [“Interpreting Error Codes” on page 133](#).

## Results

Figure 2-19 EDGE Tx Band Spur Result - Upper Adj Segment



## Troubleshooting Hints

Almost any fault in the transmitter circuits can manifest itself in spurious results of one kind or another. Make sure the transmit band is correctly selected and the frequency is either the Bottom, Middle, or Top channel. The “Unexpected carrier frequency (BMT only)” message usually indicates the transmit band and/or carrier frequency is not correct. The “ADC overload -- unexpected carrier frequency” message usually indicates the selected channel frequency does not match the carrier frequency of the signal.

## GSMK Output RF Spectrum (ORFS) Measurements

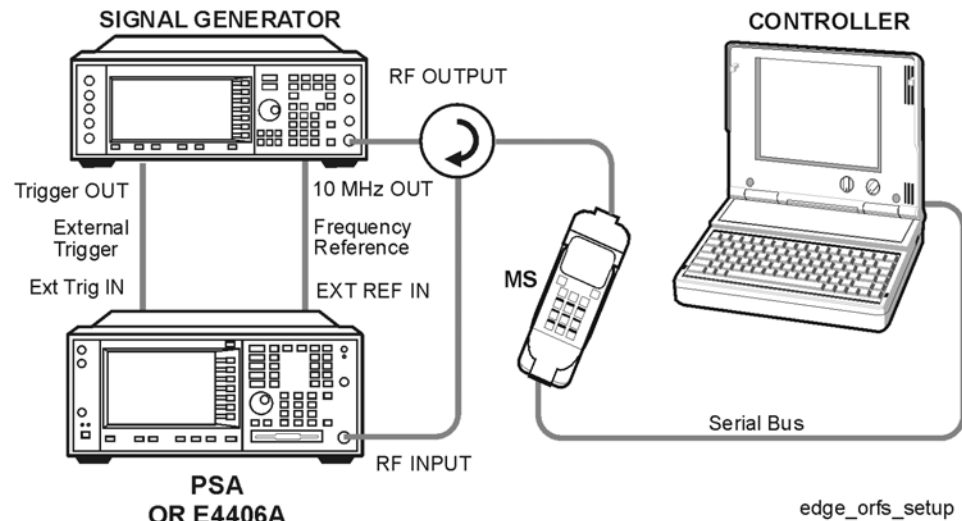
This section explains how to make a GSM Output RF Spectrum measurement on an EDGE mobile station. This test verifies that the modulation, wideband noise, and power level switching spectra are within limits and do not produce significant interference in the adjacent base transceiver station (BTS) channels.

**NOTE** This measurement is designed for GSM. For the EDGE Output RF Spectrum measurement see “EDGE Output RF Spectrum (ORFS) Measurements” on page 60.

### Configuring the Measurement System

This example shows a mobile station (MS) under test set up to transmit RF power, and being controlled remotely by a system controller. The transmitting signal is connected to the analyzer RF input port. Connect the equipment as shown.

**Figure 2-20** GSMK ORFS Measurement System



1. Using the appropriate cables, adapters, and circulator, connect the output signal of the MS to the RF input of the instrument.
2. Connect the base transmission station simulator or signal generator to the MS through a circulator to initiate a link constructed with sync and pilot channels, if required.
3. Connect a BNC cable between the 10 MHz OUT port of the signal generator and the EXT REF IN port of the instrument.

4. Connect the system controller to the MS through the serial bus cable to control the MS operation.

**NOTE**

If the signal being measured has more than one active slot in a frame, the default RF Burst trigger must be changed, and an external event trigger must be provided to synchronize the frame. Otherwise the measurement may trigger randomly on any burst in an active slot. This is true for all ORFS time domain measurements.

**Setting the MS (Example)**

From the base transmission station simulator and the system controller, set up a call using loopback mode for the MS to transmit the RF power as follows:

MS:                    Symbol Rate: 270.833kbps  
 Frequency:         935.2000 MHz (ARFCN number 1)  
 Output Power:     -30 dBm

**Measurement Procedure**

- Step 1.** Press the **Preset** key to preset the instrument.
- Step 2.** Press the **MODE**, **GSM** or **GSM (w/EDGE)** keys to enable the GSM mode measurements.
- Step 3.** Press the **Mode Setup**, **Trigger** keys to select a trigger source as described in the section titled “[EDGE Output RF Spectrum Measurement Keys](#)” on page 162.
- Step 4.** Press the **Radio**, **Device** keys to toggle the device to **MS**.
- Step 5.** Press the **FREQUENCY Channel** key to select the desired center frequency or ARFCN as described in the section titled “[FREQUENCY Channel Key Menu](#)” on page 139.
- Step 6.** Press the **Burst Type** key to select the desired burst type as described in the section titled “[FREQUENCY Channel Key Menu](#)” on page 139.
- Step 7.** If your signal of interest contains more than 1 Training Sequence, press the **TSC** key, and select a standard Training Sequence (numbered 0-9) to which the measurement will synchronize. The default setting for **TSC** is **Auto**, which will automatically correlate to any one of the standard Training Sequences numbered 0-9. See “[FREQUENCY Channel Key Menu](#)” on page 139.

**Step 8.** Press **Meas Setup** and select the **Meas Type** and **Meas Method** for your measurement:

- **Meas Type** - accesses a menu to choose the measurement that is optimized for the type of spectral distortion being investigated.
  - **Mod & Switch** - will perform both Modulation and Switching measurements, which measures the spectrum due to the 0.3 GMSK modulation and noise, and Switching (transient) measurements.
  - **Modulation** - measures the spectrum optimized for distortion due to the 0.3 GMSK modulation and noise.
  - **Switching** - measures the spectrum optimized for distortion due to switching transients (burst ramping).
  - **Full Frame Modulation (FAST)**- improves measurement speed by acquiring a full frame of data prior to performing the FFT calculation. This feature can only be used when all slots in the transmitted frame are active. Use of an external trigger can enhance measurement speed when this feature is used. When **Full Frame Modulation (FAST)** is selected the current measurement defaults to the multi-offset measurement method; therefore the **Meas Method** key is grayed out and the **Single Offset** feature is not available.
- **Meas Method** - accesses a menu to choose the measurement mode.
  - **Multi-Offset** - automatically makes measurements at all offset frequencies in the selected list (**Standard**, **Short**, or **Custom**). (See table below.) Press the **Multi-Offset Freq List** key to select a list of offsets to measure.

**Multi-Offset** measurements may be made with either **Modulation** or **Switching** measurement types.

Offset measurement results are displayed as tabular data, and may be viewed as either absolute powers in the Modulation Power and Switching Power views, or as powers relative to the margins and limit settings in the Modulation Margin and Limit and Switching Margin and Limit views. See “[GMSK Output RF Spectrum Measurement Keys](#)” on page 184, and [Figure 2-9](#) on page 63.

- **Single Offset (Examine)** - makes a measurement at a single offset frequency as set by the **Single Offset Freq** softkey.

**Single Offset (Examine)** measurements may be made with either **Modulation** or **Switching** measurement types.

Single offset measurement results are displayed in a time domain plot, with the measurement offset shown as a gate by white vertical lines. See [Figure 2-13](#) on page 67.

- **Swept** - makes a measurement using time-gated spectrum analysis to sweep the analyzer with the gate turned on for the desired portion of the burst only, as set by the **Modulation Ofs** (offsets) & **Limits** menu. The limits mask is applied to the spectrum plot, and the **Worst Frequency** parameters are displayed. This selection is only available if **Meas Type** is set to **Modulation**. See [Figure 2-16 on page 70](#).

**Step 9.** Press the **Restart** key to re-initiate a GMSK ORFS measurement if you change the **Meas Type** or **Meas Method**. You can also set **Meas Control** to **Measure Cont** for continuous measurements.

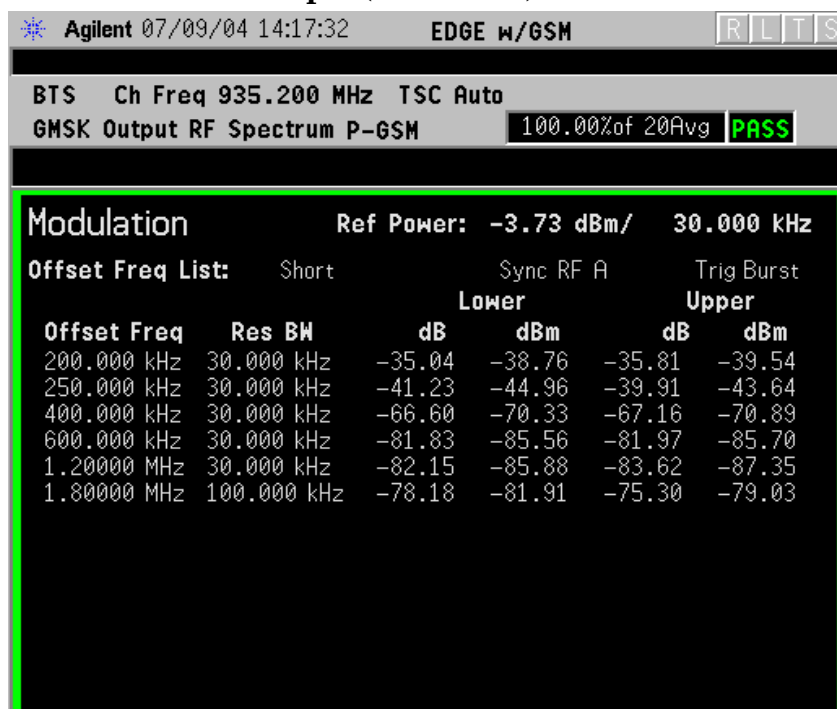
For more details about changing measurement parameters, see “[GMSK Output RF Spectrum Measurement Keys](#)” on page 184 and “[GMSK Output RF Spectrum Measurement Concepts](#)” on page 524

If you have a problem, and get an error message, see “[Interpreting Error Codes](#)” on page 133.

### GMSK ORFS Measurement Results

- **Modulation Power** - When **Meas Method** is set to **Multi-Offset**, and **Meas Type** is set to **Modulation**, or **Mod and Switch**, measurement results may be viewed as absolute powers in tabular form. The data will display offsets from any of the the **Multi-Offset Freq List** settings: **Standard**, **Short**, and **Custom**. The **Modulation Power** view is the default view for ORFS measurements. You can select the **Modulation Power** view by pressing **View/Trace**, then **Modulation Power**.

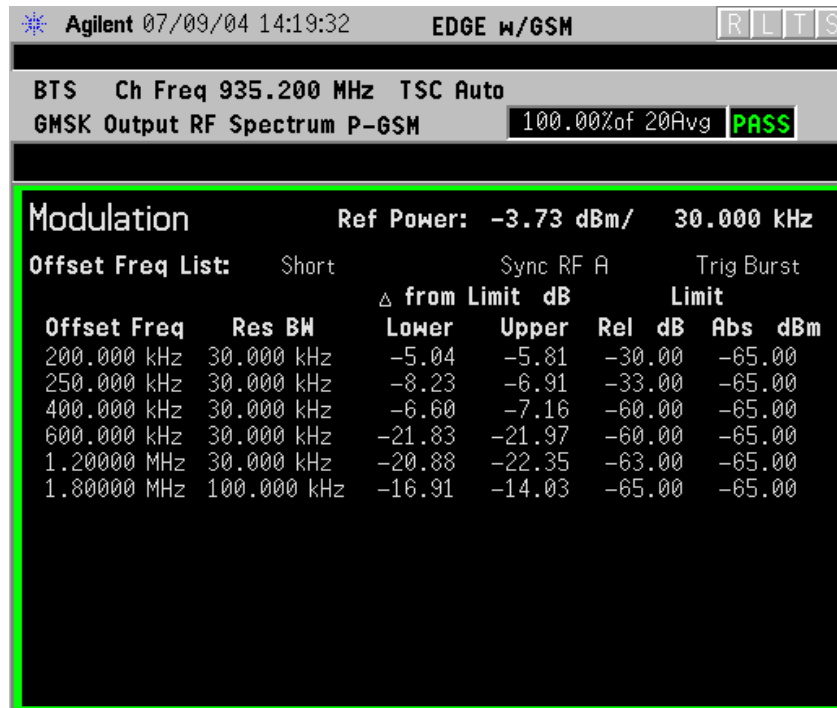
**Figure 2-21** GMSK ORFS - Example (Short List) Modulation Power View



- **Modulation Margin & Limits**- When **Meas Method** is set to **Multi-Offset**, and **Meas Type** is set to **Modulation**, or **Mod and Switch**, measurement results may be viewed as relative powers in tabular form. The data will display offsets from any of the the **Multi-Offset Freq List** settings: **Standard**, **Short**, and **Custom**, and shows the limit values selected by frequency, with the corresponding measurement result deltas.

You can select the **Modulation Margin and Limits** view by pressing **View/Trace**, then **Modulation Margin and Limits**.

**Figure 2-22 GMSK ORFS Result - Example (Short List) Modulation Margin & Limits View**



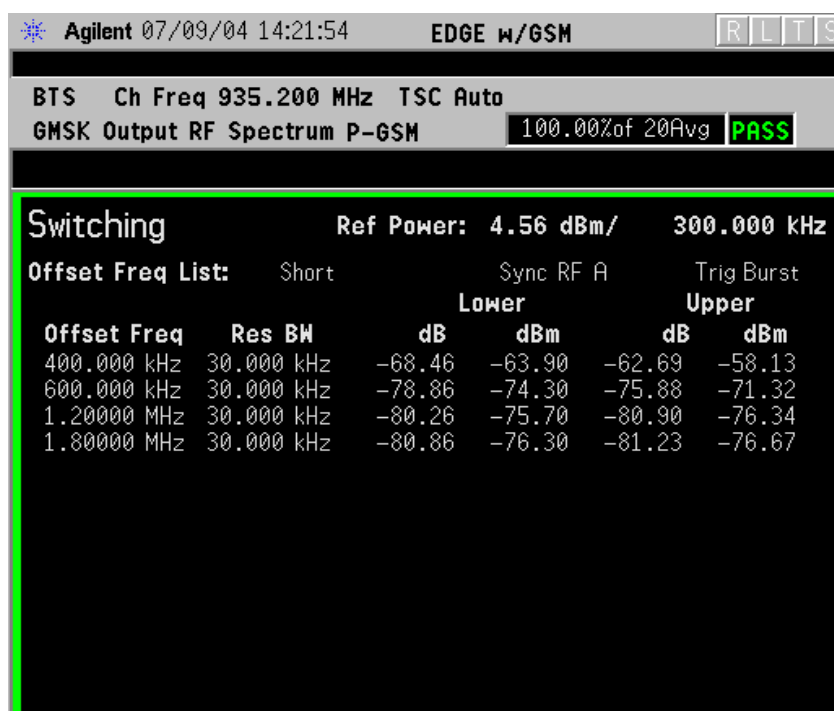
For more details about changing measurement parameters, see “GMSK Output RF Spectrum Measurement Keys” on page 184 and “GMSK Output RF Spectrum Measurement Concepts” on page 524

If you have a problem, and get an error message, see “Interpreting Error Codes” on page 133.

- **Switching Power** - When **Meas Method** is set to **Multi-Offset**, and **Meas Type** is set to **Switching**, or **Mod and Switch**, measurement results may be viewed as absolute powers in tabular form. The data will display offsets from any of the the **Multi-Offset Freq List** settings: **Standard**, **Short**, and **Custom**.

You can select the **Switching Power** view by pressing **View/Trace**, then **Switching Power**.

**Figure 2-23 GMSK ORFS Result - Example (Short List) Switching Power View**



For more details about changing measurement parameters, see “GMSK Output RF Spectrum Measurement Keys” on page 184 and “GMSK Output RF Spectrum Measurement Concepts” on page 524

If you have a problem, and get an error message, see “Interpreting Error Codes” on page 133.



- **Switching Margin & Limits** - When **Meas Method** is set to **Multi-Offset**, and **Meas Type** is set to **Switching** or **Mod and Switch**, measurement results may be viewed as relative powers in tabular form. The data will display offsets from any of the the **Multi-Offset Freq List** settings: **Standard**, **Short**, and **Custom**, and shows the limit values selected by frequency, with the corresponding measurement result deltas.

You can select the **Switching Margin & Limits** view by pressing **View/Trace**, then **Switching Margin & Limits** .

**Figure 2-24 GMSK ORFS Result - Switching Margin & Limits View**



For more details about changing measurement parameters, see “GMSK Output RF Spectrum Measurement Keys” on page 184 and “GMSK Output RF Spectrum Measurement Concepts” on page 524

If you have a problem, and get an error message, see “Interpreting Error Codes” on page 133.

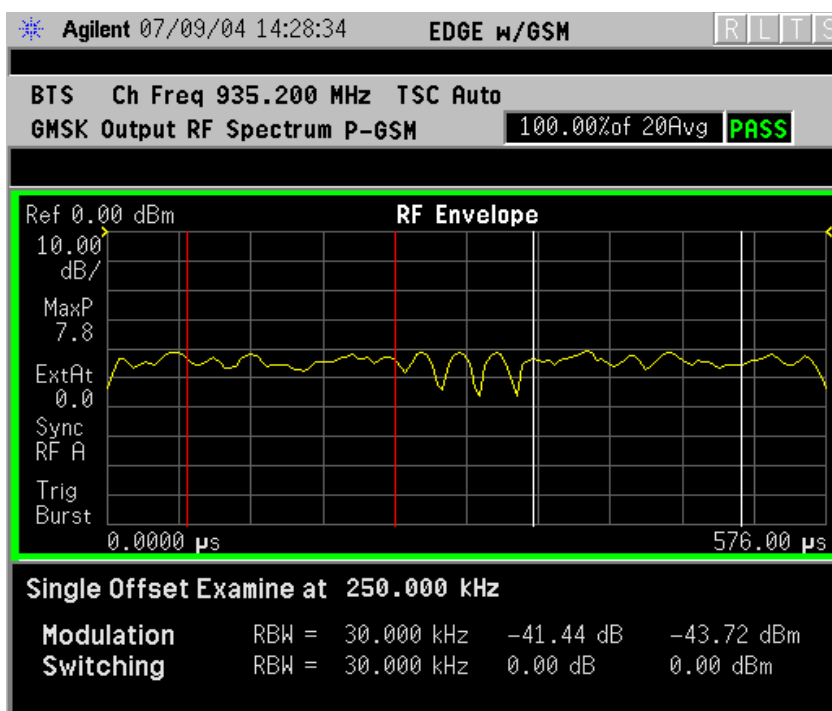
- **Single Offset (Examine)** - makes a measurement at a single offset frequency as set by the **Offset Freq** softkey.

Single offset measurement results are displayed as a power waveform in a time domain plot, with the measurement offset shown as a gate by white vertical lines. The red vertical lines represent the additional effective measurement window when **Fast Avg** is **ON** (default setting).

**NOTE**

The signal being displayed below is the useful part of slot 1, which in this example, is the only active slot in the frame. If any other slots are active, the default RF Burst trigger must be changed, and an external event trigger must be provided to synchronize the frame. Otherwise the measurement may trigger randomly on any burst in an active slot. This is true for all ORFS time domain measurements.

**Figure 2-25 GMSK ORFS Result - Modulation Single Offset (Examine) View**

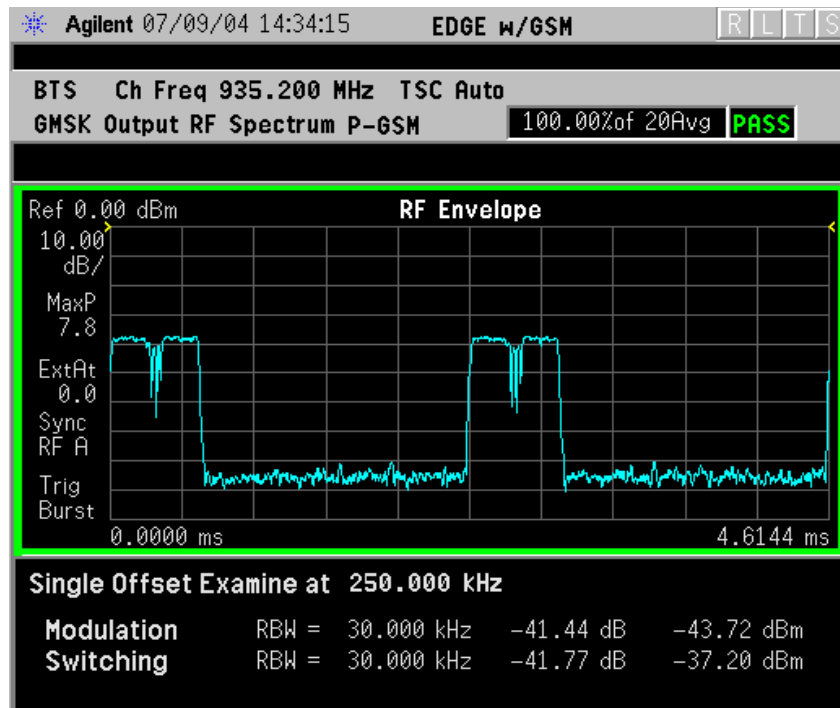


For more details about changing measurement parameters, see “GMSK Output RF Spectrum Measurement Keys” on page 184 and “GMSK Output RF Spectrum Measurement Concepts” on page 524

If you have a problem, and get an error message, see “Interpreting Error Codes” on page 133.

- Switching Single Offset measurement results are displayed in a time domain plot, but the waveform of the entire frame is displayed. In this example, slots 1 and 4 are active. Use the external trigger to maintain frame synchronization. **Fast Avg** is not available for this measurement.

**Figure 2-26 GMSK ORFS Result - Switching Single Offset (Examine) View**



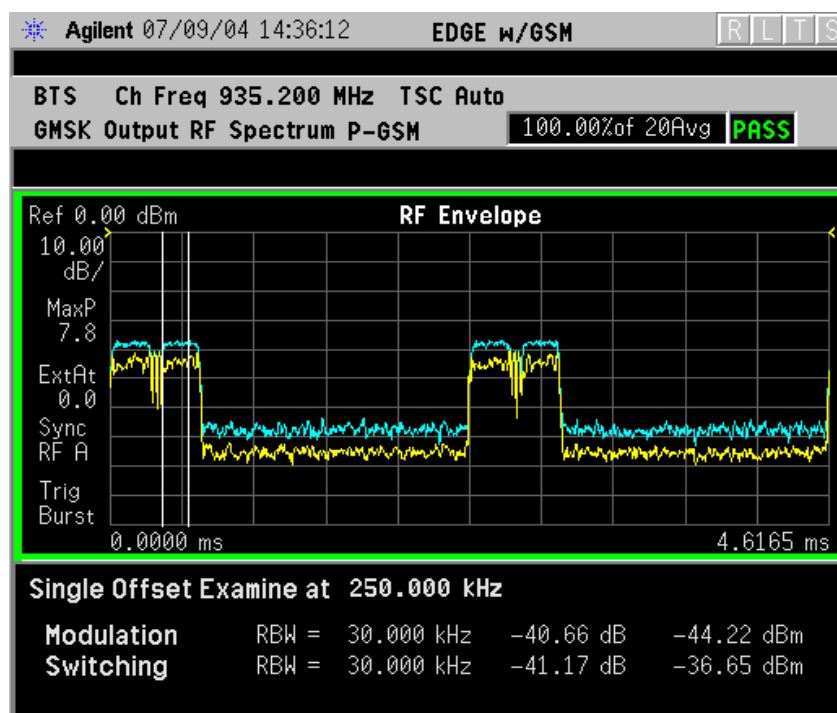
For more details about changing measurement parameters, see “GMSK Output RF Spectrum Measurement Keys” on page 184 and “GMSK Output RF Spectrum Measurement Concepts” on page 524

If you have a problem, and get an error message, see “Interpreting Error Codes” on page 133.

- Combination Modulation and Switching (**Mod & Switch**) Single Offset measurement results are displayed in a time domain plot, but the waveform of the entire frame is displayed. The blue trace is the Switching data and the yellow trace is the Modulation data, with the measurement gates shown.

In this example, slots 1 and 4 are active. Use the external trigger to maintain frame synchronization. **Fast Avg** is not available for this measurement.

**Figure 2-27 GMSK ORFS Result - Mod & Switch Single Offset (Examine) View**

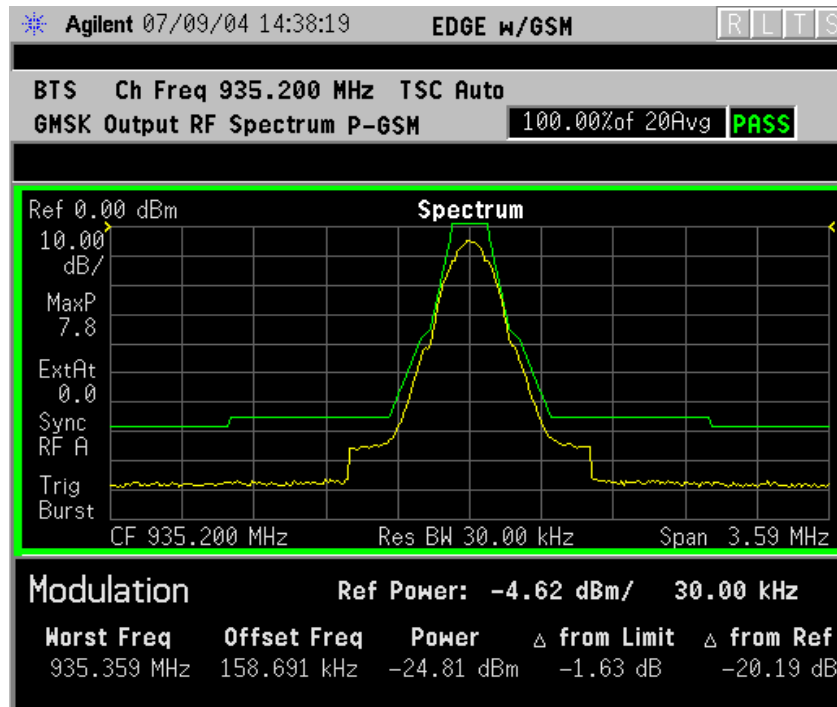


For more details about changing measurement parameters, see “GMSK Output RF Spectrum Measurement Keys” on page 184 and “GMSK Output RF Spectrum Measurement Concepts” on page 524

If you have a problem, and get an error message, see “Interpreting Error Codes” on page 133.

- **Swept** - When **Meas Type** is set to **Modulation** and **Meas Method** is set to **Swept**, measurement results may be viewed in the spectrum domain, with the limit mask applied to the spectrum plot, and the **Worst Frequency** parameters displayed. This selection is only available if **Meas Type** is set to **Modulation**.

**Figure 2-28 GMSK ORFS Result - Example Modulation Swept View**



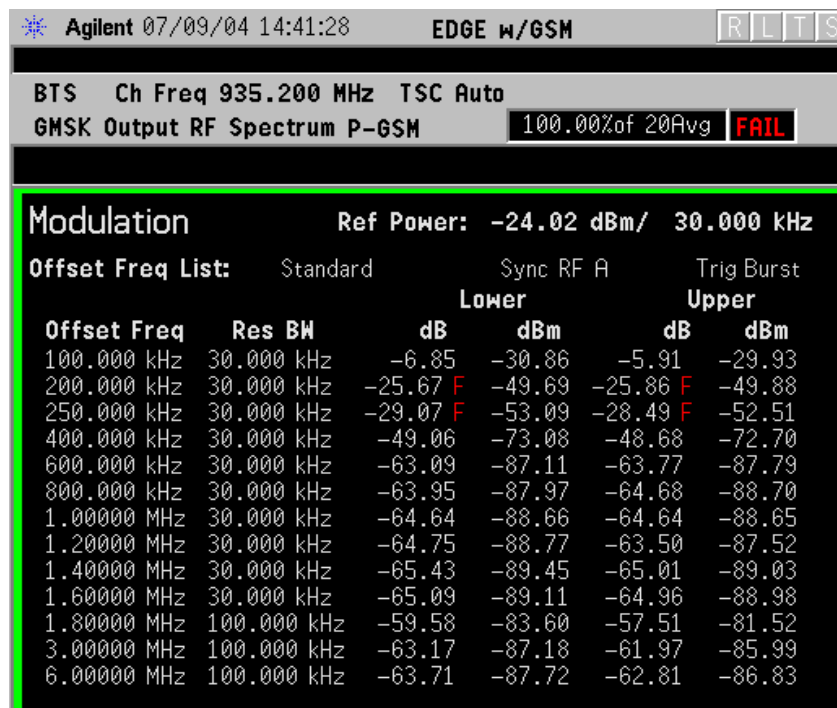
For more details about changing measurement parameters, see “GMSK Output RF Spectrum Measurement Keys” on page 184 and “GMSK Output RF Spectrum Measurement Concepts” on page 524

If you have a problem, and get an error message, see “Interpreting Error Codes” on page 133.

- **Full Frame Mode (FAST)** - When **Meas Method** is set to **Multi-Offset**, and **Meas Type** is set to **Full Frame Mode (FAST)**, measurement results may be viewed as relative and absolute powers in tabular form. The data will display offsets from any of the the **Multi-Offset Freq List** settings: **Standard**, **Short**, and **Custom**.

To measure **Full Frame Mode (FAST)**, all slots in the frame must be active. In the example below, slots 6 and 7 were inactive.

**Figure 2-29 GMSK ORFS Result - Full Frame Modulation (FAST) View**



For more details about changing measurement parameters, see “GMSK Output RF Spectrum Measurement Keys” on page 184 and “GMSK Output RF Spectrum Measurement Concepts” on page 524

If you have a problem, and get an error message, see “Interpreting Error Codes” on page 133.

## GMSK Phase and Frequency Error Measurements

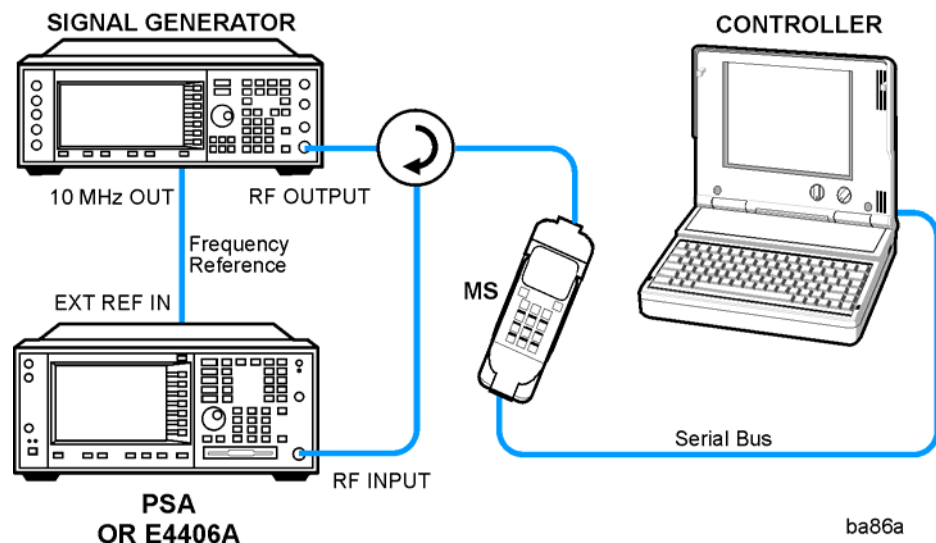
This section explains how to make a GMSK Phase and Frequency Error measurement on a GSM mobile station. Good measurement results Verify modulation quality of the 0.3 GMSK signal for GSM systems. The modulation quality indicates the carrier to noise performance of the system, which is critical for mobiles with low signal levels, at the edge of a cell, or under difficult fading or Doppler conditions.

**NOTE** This measurement is designed for GSM only.

### Configuring the Measurement System

This example shows a mobile station (MS) under test set up to transmit RF power, and being controlled remotely by a system controller. The transmitting signal is connected to the analyzer RF input port. Connect the equipment as shown.

**Figure 2-30** GMSK Phase and Frequency Measurement System



1. Using the appropriate cables, adapters, and circulator, connect the output signal of the MS to the RF input of the instrument.
2. Connect the base transmission station simulator or signal generator to the MS through a circulator to initiate a link constructed with sync and pilot channels, if required.
3. Connect a BNC cable between the 10 MHz OUT port of the signal generator and the EXT REF IN port of the instrument.
4. Connect the system controller to the MS.

## Setting the MS (Example)

From the base transmission station simulator and the system controller, set up a call using loopback mode for the MS to transmit the RF power as follows:

MS:                    Symbol Rate: 270.833kbps  
Frequency:        935.2000 MHz (ARFCN number 1)  
Output Power:    -3 dBW (0.5 W)

## Measurement Procedure

- Step 1.** Press the **Preset** key to preset the instrument.
- Step 2.** Press the **MODE, GSM (w/EDGE)** keys to enable the GSM with EDGE mode measurements.
- Step 3.** Press the **Mode Setup, Trigger** keys to select a trigger source as described in the section titled [“GMSK Phase and Frequency Error Measurement Keys” on page 195](#).
- Step 4.** Press the **Radio, Device** keys to toggle the device to **MS**.
- Step 5.** Press the **FREQUENCY Channel** key to select the desired center frequency or ARFCN as described in the section titled [“FREQUENCY Channel Key Menu” on page 139](#).
- Step 6.** Press the **Burst Type** key to select the desired burst type as described in the section titled [“FREQUENCY Channel Key Menu” on page 139](#).
- Step 7.** If your signal of interest contains more than 1 Training Sequence, press the **TSC** key, and select a standard Training Sequence (numbered 0-9) to which the measurement will synchronize. The default setting for **TSC** is **Auto**, which will automatically correlate to any one of the standard Training Sequences numbered 0-9. See [“FREQUENCY Channel Key Menu” on page 139](#).
- Step 8.** Press the **MEASURE, GMSK Phase & Freq** keys to initiate the Phase and Frequency Error measurement.

For more details about changing measurement parameters, see [“GMSK Phase and Frequency Error Measurement Concepts” on page 521](#)

If you have a problem, and get an error message, see [“Interpreting Error Codes” on page 133](#).



## Results

Figure 2-31 GMSK Phase and Frequency Error Result - Quad View

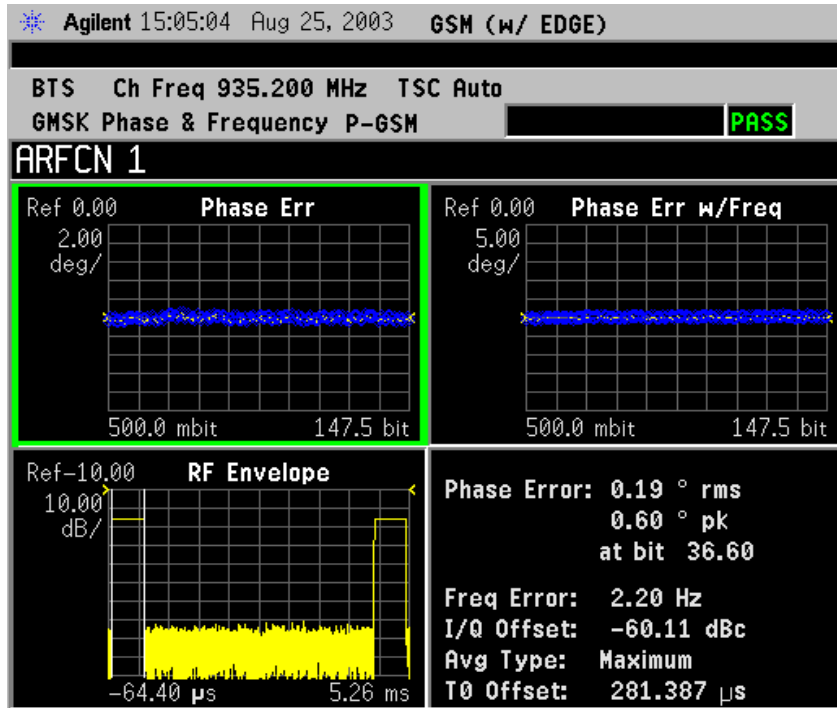


Figure 2-32 GMSK Phase and Frequency Error Result - Phase Error View

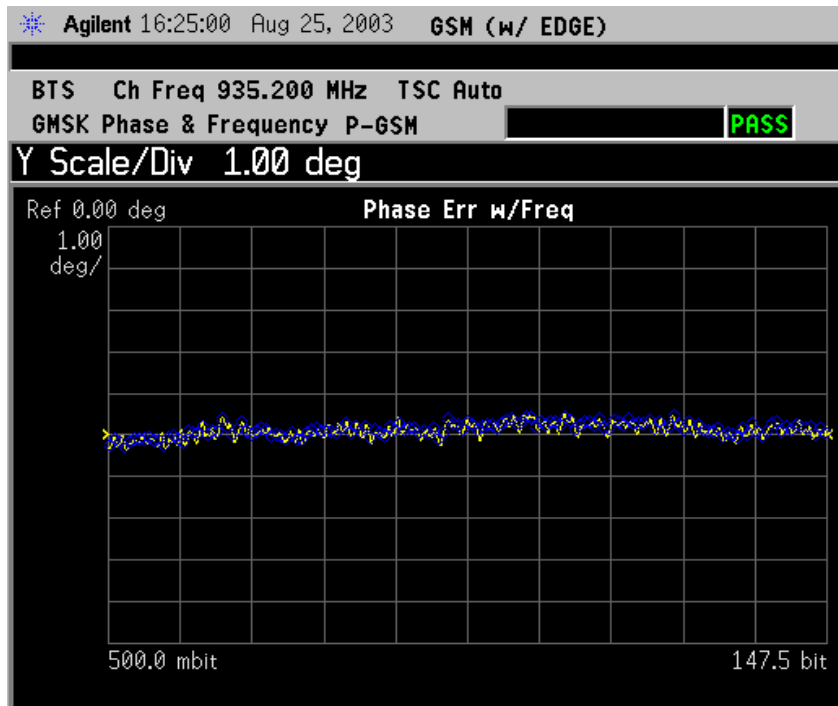


Figure 2-33 GMSK Phase and Frequency Error Result - RF Envelope View

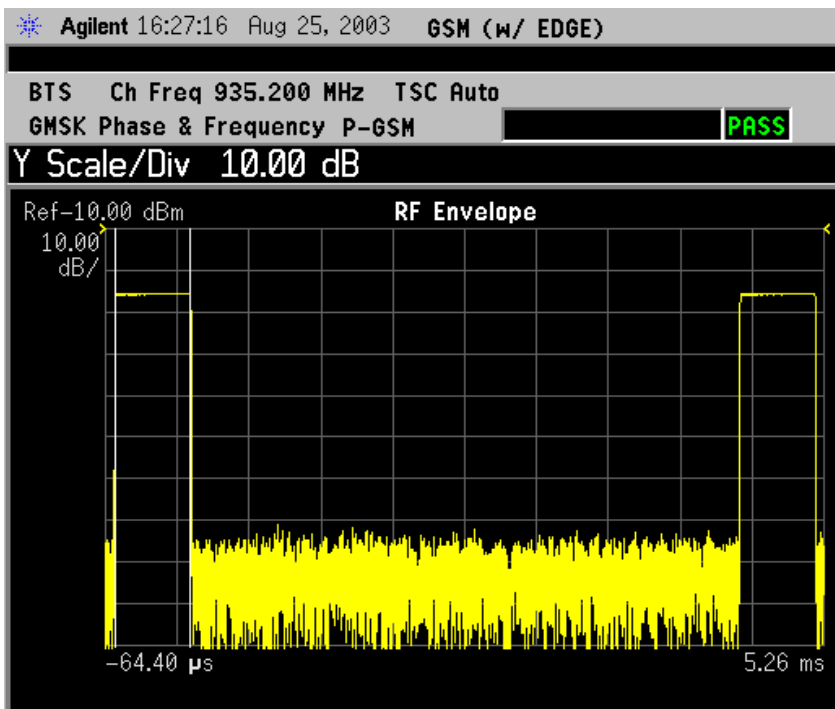
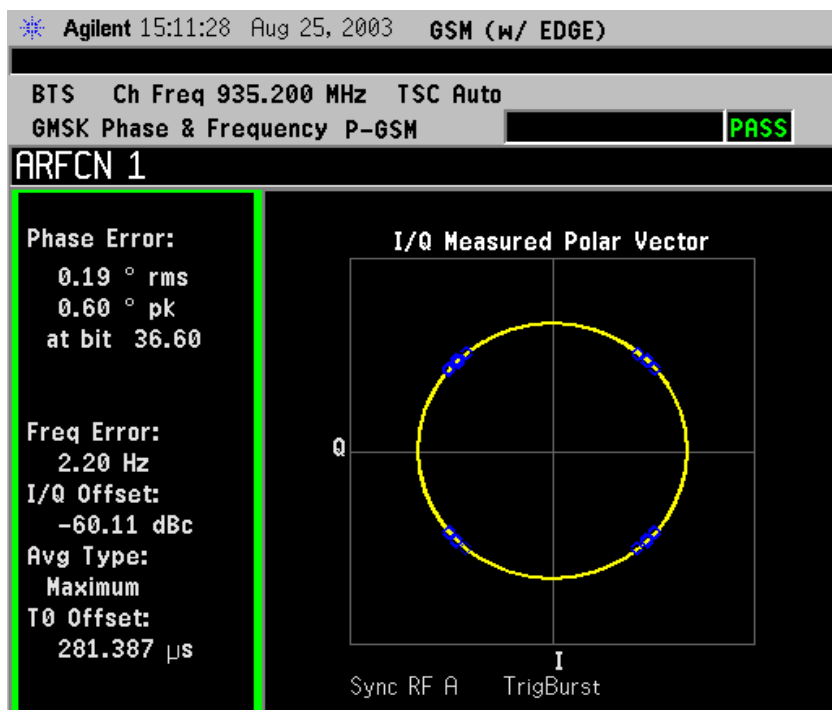
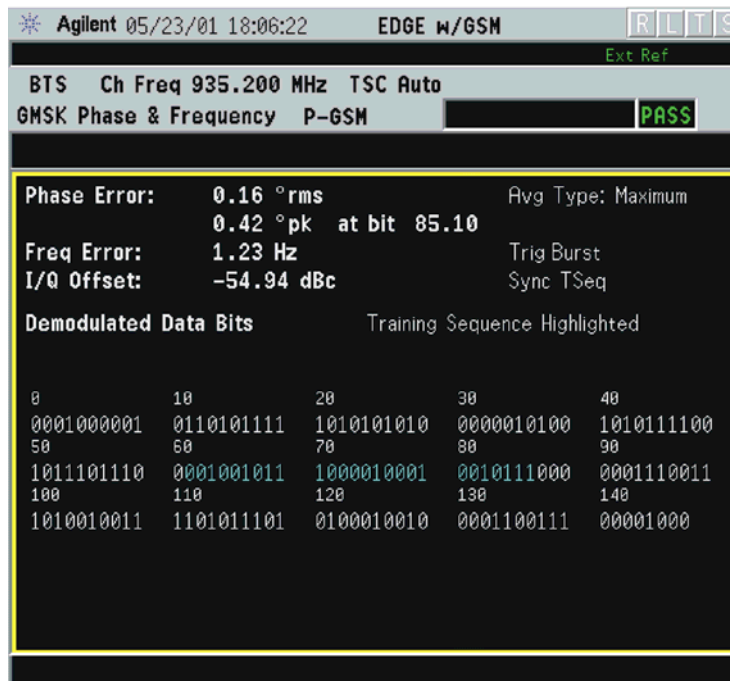


Figure 2-34 GMSK Phase and Frequency Error Result - Polar View



**Figure 2-35** GSMK Phase and Frequency Error Result - Data Bits



### Troubleshooting Hints

Poor phase error indicates a problem with the I/Q baseband generator, filters, or modulator in the transmitter circuitry. The output amplifier in the transmitter can also create distortion that causes unacceptably high phase error. In a real system poor phase error will reduce the ability of a receiver to correctly demodulate, especially in marginal signal conditions. This ultimately affects range.

Occasionally, a Phase and Frequency Error measurement may fail the prescribed limits at only one point in the burst, for example at the beginning. This could indicate a problem with the transmitter power ramp or some undesirable interaction between the modulator and power amplifier.

## GMSK Power vs. Time (PvT) Measurements

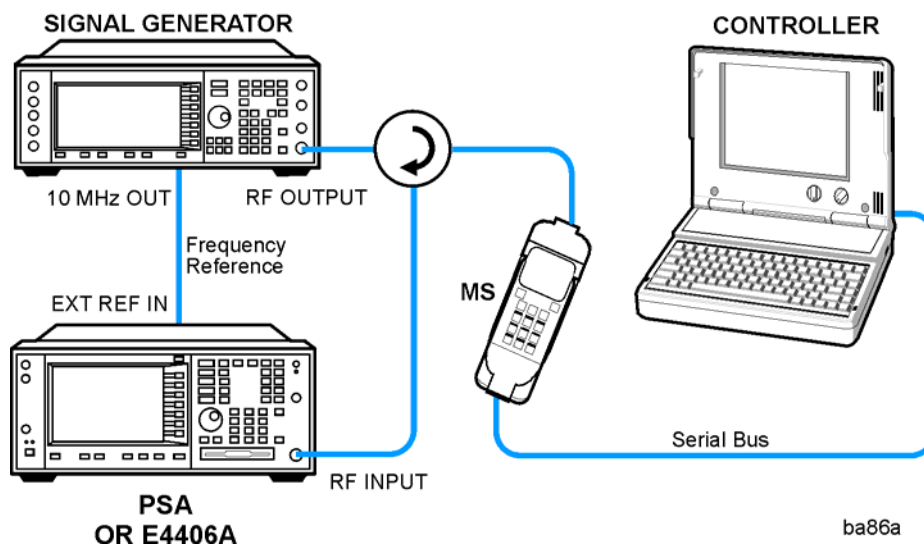
This section explains how to make a GMSK Power versus Time (PvT) measurement on a GSM mobile station. Good PvT measurement results verify that the transmitter output power has the correct amplitude, shape, and timing for the GSM format.

**NOTE** This measurement is designed for GSM. For the EDGE PvT measurement see “EDGE Power vs. Time (PVT) Measurements” on page 50.

### Configuring the Measurement System

This example shows a mobile station (MS) under test set up to transmit RF power, and being controlled remotely by a system controller. The transmitting signal is connected to the analyzer RF input port. Connect the equipment as shown.

**Figure 2-36** GMSK Pwr vs Time T Measurement System



1. Using the appropriate cables, adapters, and circulator, connect the output signal of the MS to the RF input of the instrument.
2. Connect the base transmission station simulator or signal generator to the MS through a circulator to initiate a link constructed with sync and pilot channels, if required.
3. Connect a BNC cable between the 10 MHz OUT port of the signal generator and the EXT REF IN port of the instrument.
4. Connect the system controller to the MS through the serial bus cable to control the MS operation.

## Setting the MS (Example)

From the base transmission station simulator and the system controller, set up a call using loopback mode for the MS to transmit the RF power as follows:

MS:                    Symbol Rate: 270.833kbps  
Frequency:        935.2000 MHz (ARFCN number 1)  
Output Power:    -3 dBW (0.5 W)

## Measurement Procedure

- Step 1.** Press the **Preset** key to preset the instrument.
- Step 2.** Press the **MODE, GSM (w/EDGE)** keys to enable the EDGE mode measurements.
- Step 3.** Press the **Mode Setup, Trigger** keys to select a trigger source as described in the section titled [“GMSK Power vs. Time Measurement Keys” on page 201](#).
- Step 4.** Press the **Radio, Band** keys to select the desired band. This will determine the frequency and band-related presets. Our example will use the default setting, **P-GSM**.
- Step 5.** Press the **Radio, Device** keys to toggle the device to **MS**.
- Step 6.** Press the **FREQUENCY Channel** key to select the desired center frequency or ARFCN as described in the section titled [“FREQUENCY Channel Key Menu” on page 139](#).
- Step 7.** Press the **Burst Type** key to select the desired burst type as described in the section titled [“FREQUENCY Channel Key Menu” on page 139](#).
- Step 8.** If your signal of interest contains more than 1 Training Sequence, press the **TSC** key, and select a standard Training Sequence (numbered 0-7) to which the measurement will synchronize. The default setting for **TSC** is **Auto**, which will automatically correlate to any one of the standard Training Sequences numbered 0-7. See [“FREQUENCY Channel Key Menu” on page 139](#).
- Step 9.** Press the **MEASURE, GMSK Pwr vs Time** keys to initiate the EDGE Power vs Time measurement.
- Step 10.** Press the **Meas Setup, More, Pwr Ctrl Lvl** keys to select the desired power control level. Our example will use the default setting **0**.

For more details about changing measurement parameters, see [“GMSK Power vs. Time Measurement Concepts” on page 515](#)

If you have a problem, and get an error message, see [“Interpreting Error Codes” on page 133](#).

## Results

The views available under the **View/Trace** menu are **Burst**, **Rise & Fall**, and **Multi-Slot**.

Information shown in the left margin of the displays include:

- **MaxP** - This is total input power allowed for the measurement. This value is coupled to the internal RF **Input Atten** setting.
- **ExtAt** - This value reflects the **External RF Atten** setting.
- **Sync** - The **Burst Sync** setting used in the current measurement
- **Trig** - The **Trigger Source** setting used in the current measurement

The **Mean Transmit Power** is displayed at the bottom left of the Burst and Rise & Fall views:

- **Mean Transmit Power** - This is the RMS average power across the “useful” part of the burst, or the 147 bits centered on the transition from bit 13 to bit 14 (the “T0” time point) of the 26 bit training sequence. An RMS calculation is performed and displayed regardless of the averaging mode selected for the trace data.

If Averaging = ON, the result displayed is the RMS average power of all bursts measured. If Averaging = OFF, the result is the RMS average power of the single burst measured. This is a different measurement result from Mean Transmit Pwr, below.

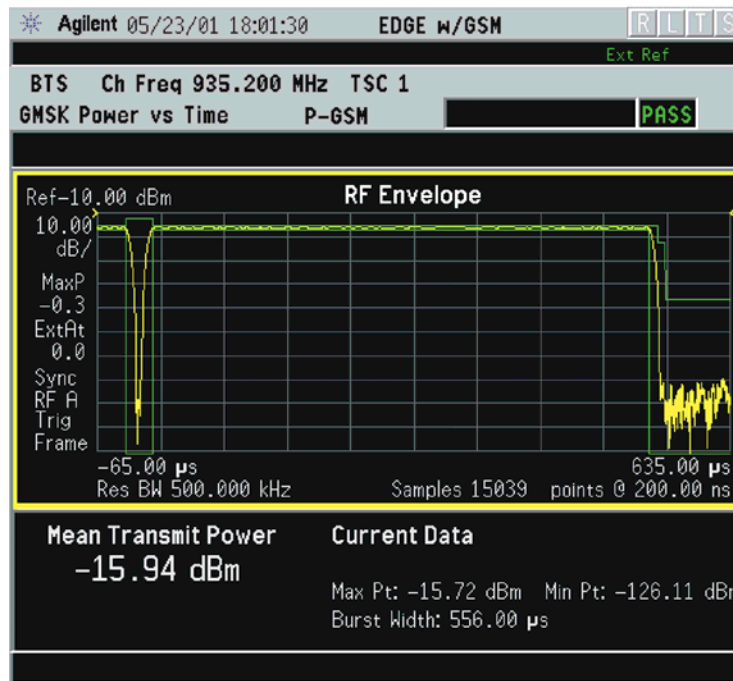
The **Current Data** displayed at the bottom of the Burst and Rise & Fall views include:

- **Mean Transmit Pwr** - This result appears only if Averaging = ON. It is the RMS average of power across the “useful” part of the burst, for the current burst only. If a single measurement of “n” averages has been completed, the result will indicate the Mean Transmit Pwr of the last burst. The RMS calculation is performed and displayed regardless of the averaging mode selected for the trace data. This is a different measurement result from Mean Transmit Power, above.
- **Max Pt.** - Maximum signal power point in dBm
- **Min Pt.** - Minimum signal power point in dBm
- **Burst Width** - Time duration of burst at -3 dB power point (half-power)
- **Mask Ref Pwr Midamble** - The Mask Reference Power is the average power in dBm of the middle 16 symbols in the midamble. The times displayed are the corresponding start and stop times of the middle 16 symbols.
- **1st Error Pt** - (Error Point) The time (displayed in ms or  $\mu$ s) indicates the point on the X Scale where the first failure of a signal

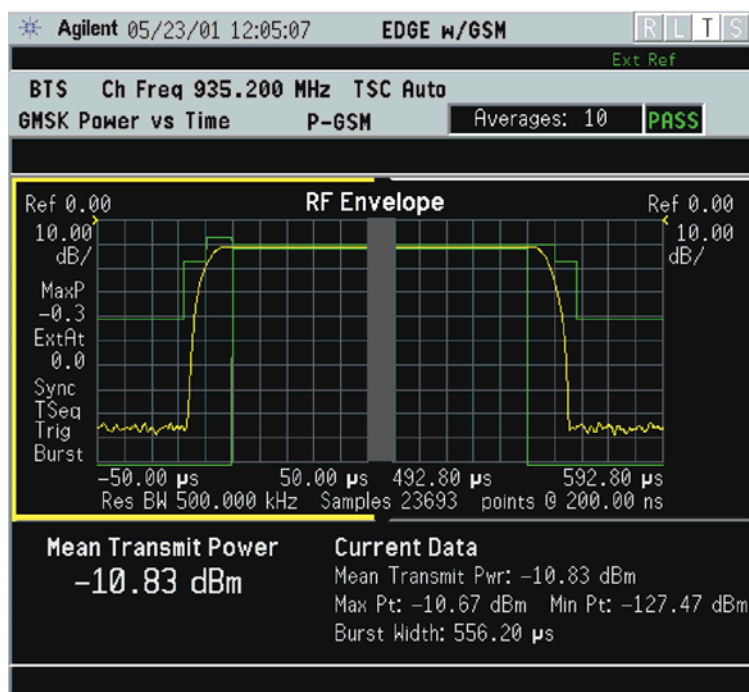
was detected. Use a marker to locate this point in order to examine the nature of the failure.

The table in the lower portion of the multi-slot view shows the output power in dBm for each timeslot, as determined by the integer (1 to 8) entered in the **Meas Setup, Meas Time** setting. Output power levels are presented for the active slots; a dashed line will appear for any slot that is inactive. The timeslot that contains the burst of interest is highlighted in blue.

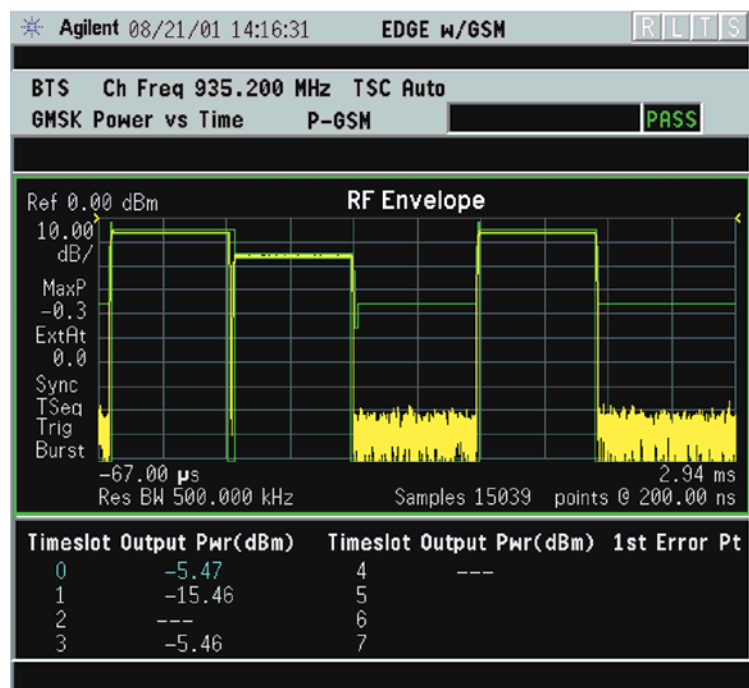
**Figure 2-37** GMSK Power vs. Time Result - Burst View



**Figure 2-38** GMSK Power vs. Time Result - Rise & Fall View

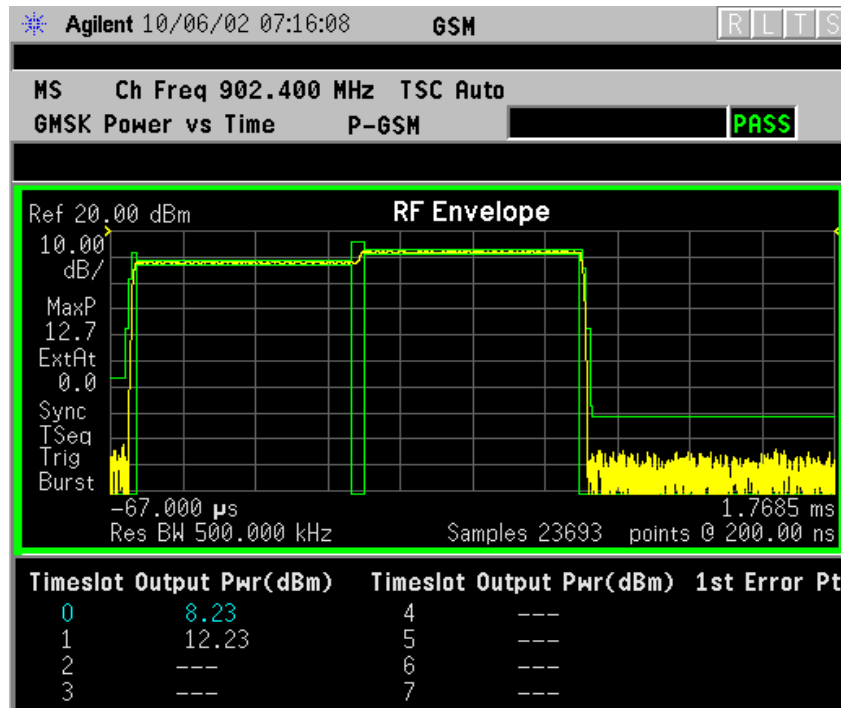


**Figure 2-39** GMSK Power vs. Time Result - Multi-Slot View (5 slots shown)

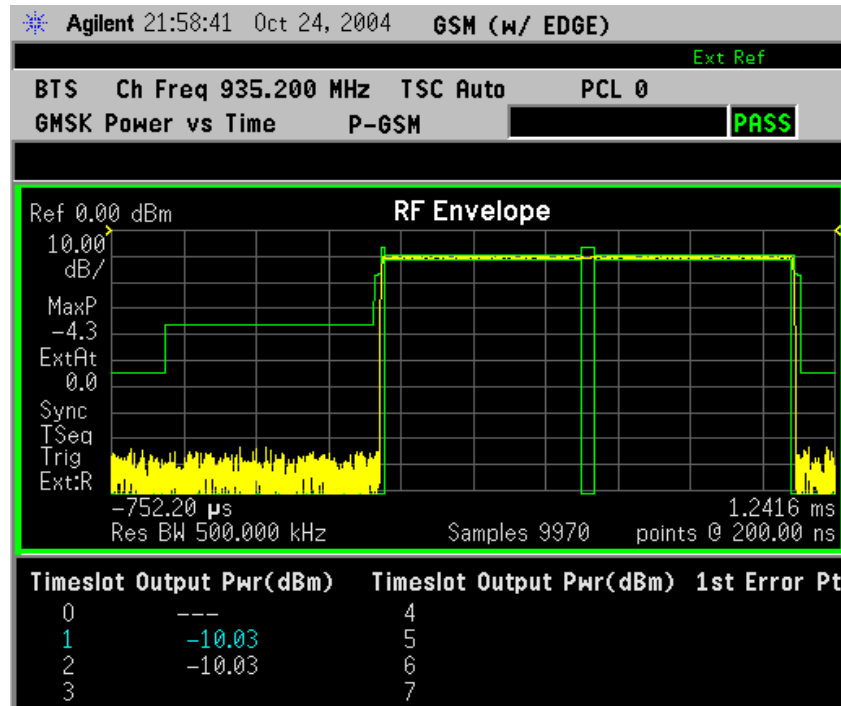




**Figure 2-40** GPRS Power vs. Time Result - Multi-Slot View (2 slots shown)



**Figure 2-41** GSMK PvT Result - Custom Limit Mask Example of Two Consecutive Bursts



For more information on making measurements of two consecutive bursts, including the SCPI commands used to make the measurement, refer to the section in the Programming Commands chapter. See “GMSK PvT Custom Limit Mask Example of Two Consecutive Bursts” on page 459.

### **Troubleshooting Hints**

If a transmitter fails the Power vs. Time measurement this usually indicates a problem with the units output amplifier or leveling loop.

## GMSK Transmitter Band Spurious Signal (Tx Band Spur) Measurements

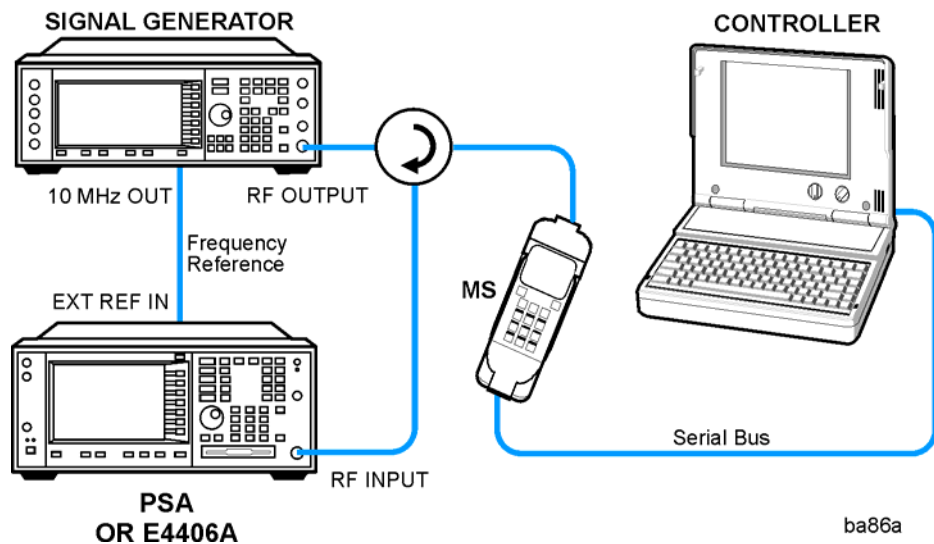
This section explains how to make a GMSK Tx Band Spur measurement on a GSM mobile station. Good measurement results verify that the transmitter does not transmit undesirable energy into the transmit band. This energy may cause interference for other users of the GSM system.

**NOTE** This measurement is designed for GSM. For the EDGE Tx Band Spur measurement see “EDGE Tx Band Spur Measurements” on page 72.

### Configuring the Measurement System

This example shows a mobile station (MS) under test set up to transmit RF power, and being controlled remotely by a system controller. The transmitting signal is connected to the analyzer RF input port.

**Figure 2-42** GMSK Transmitter Band Spurious Measurement System



1. Using the appropriate cables, adapters, and circulator, connect the output signal of the MS to the RF input of the instrument.
2. Connect the base transmission station simulator or signal generator to the MS through a circulator to initiate a link constructed with sync and pilot channels, if required.
3. Connect a BNC cable between the 10 MHz OUT port of the signal generator and the EXT REF IN port of the instrument.
4. Connect the system controller to the MS through the serial bus cable to control the MS operation.

## Setting the MS (Example)

From the base transmission station simulator and the system controller, set up a call using loopback mode for the MS to transmit the RF power as follows:

MS:                    Symbol Rate: 270.833kbps  
Frequency:        935.2000 MHz (ARFCN number 1)  
Output Power:    -3 dBW (0.5 W)

## Measurement Procedure

- Step 1.** Press the **Preset** key to preset the instrument.
- Step 2.** Press the **MODE, GSM with EDGE** keys to enable the GSM with EDGE mode measurements.
- Step 3.** Press the **Mode Setup, Trigger** keys to select a trigger source as described in the section titled [“GMSK Tx Band Spur Measurement Keys” on page 211](#).
- Step 4.** Press the **Radio, Device** keys to toggle the device to **MS**.
- Step 5.** Press the **FREQUENCY Channel** key to select the desired center frequency or ARFCN as described in the section titled [“FREQUENCY Channel Key Menu” on page 139](#).
- Step 6.** Press the **Burst Type** key to select the desired burst type as described in the section titled [“FREQUENCY Channel Key Menu” on page 139](#).
- Step 7.** If your signal of interest contains more than 1 Training Sequence, press the **TSC** key, and select a standard Training Sequence (numbered 0-9) to which the measurement will synchronize. The default setting for **TSC** is **Auto**, which will automatically correlate to any one of the standard Training Sequences numbered 0-9. See [“FREQUENCY Channel Key Menu” on page 139](#).
- Step 8.** Press the **MEASURE, GMSK Tx Band Spur** keys to initiate the Transmitter Band Spurious products measurement.

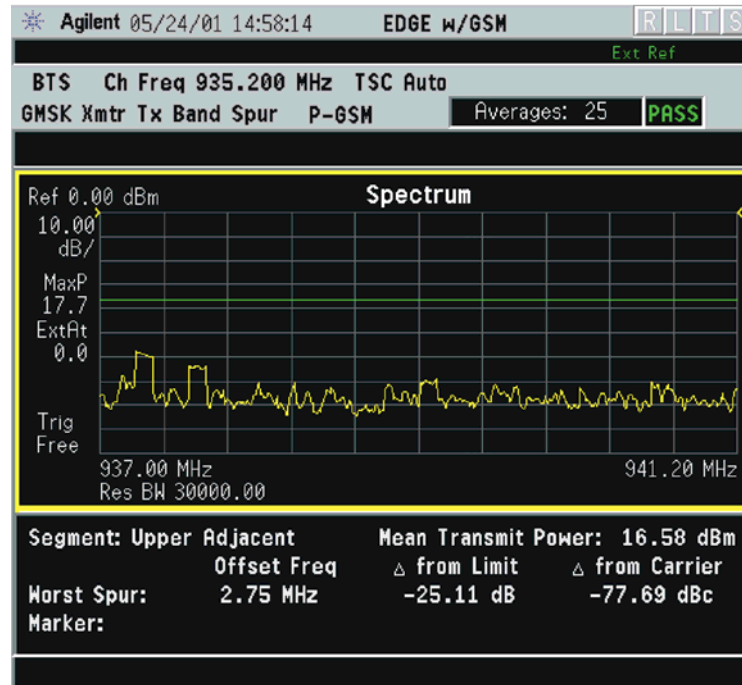
For more details about changing measurement parameters, see [“GMSK Tx Band Spur Measurement Concepts” on page 528](#)

If you have a problem, and get an error message, see [“Interpreting Error Codes” on page 133](#).

## Results

Figure 2-43

### GMSK Tx Band Spur Result - Upper Segment



## Troubleshooting Hints

Almost any fault in the transmitter circuits can manifest itself as spurious of one kind or another. Make sure the transmit band is correctly selected and the frequency is either the Bottom, Middle, or Top channel. The “Unexpected carrier frequency (BMT only)” message usually indicates the transmit band and/or carrier frequency is not correct. The “ADC overload -- unexpected carrier frequency” message usually indicates the selected channel frequency does not match the carrier frequency of the signal.

## Spectrum (Frequency Domain) Measurements

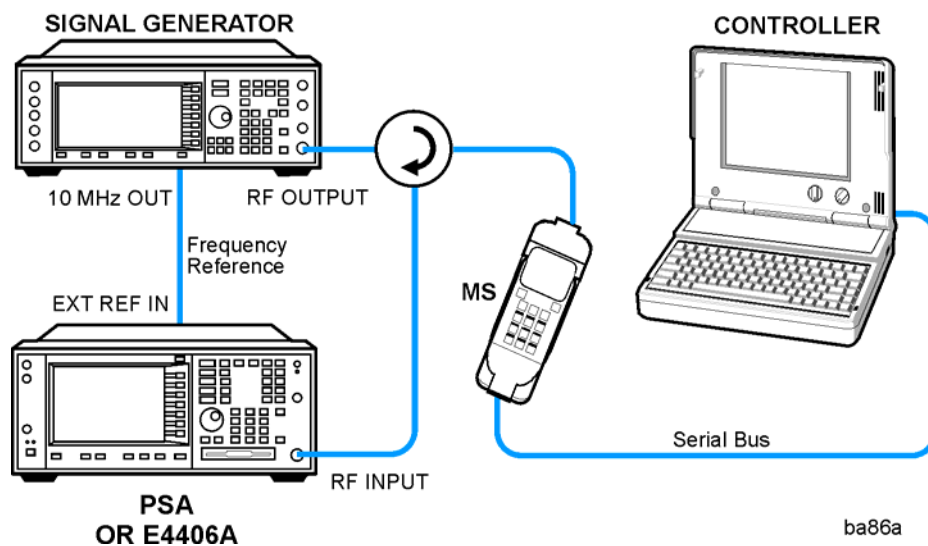
This section explains how to make a frequency domain measurement on a GSM with EDGE mobile station. An adjacent or an interfering signal can also be applied, if desired, during spectrum measurements.

If installed, you may use PSA Option 122, the 80 MHz Bandwidth Digitizer hardware to perform Spectrum measurements of wideband signals using Basic Mode or PSA Option 241, Flexible Digital Modulation Analysis mode.

### Configuring the Measurement System

This example shows a mobile station (MS) under test set up to transmit RF power, and being controlled remotely by a system controller. The transmitting signal is connected to the analyzer RF input port. Connect the equipment as shown.

Figure 2-44 Spectrum Measurement System



1. Using the appropriate cables, adapters, and circulator, connect the output signal of the MS to the RF input of the instrument.
2. Connect the base transmission station simulator or signal generator to the MS through a circulator to initiate a link constructed with sync and pilot channels, if required.
3. Connect a BNC cable between the 10 MHz OUT port of the signal generator and the EXT REF IN port of the instrument.
4. Connect the system controller to the MS through the serial bus cable to control the MS operation.

## Setting the MS

From the base transmission station simulator and the system controller, set up a call using loopback mode to allow the MS to transmit RF signal.

## Measurement Procedure

- Step 1.** Press the **Preset** key to preset the instrument.
- Step 2.** Press the **MODE, GSM with EDGE** keys to enable the GSM with EDGE Mode measurements.
- Step 3.** Press the **Mode Setup, Radio, Device** keys to toggle the device to **MS**.
- Step 4.** To set the measurement center frequency press the **FREQUENCY Channel** key, enter a numerical frequency using the front-panel keypad, and complete the entry by selecting a units key, like **MHz**.
- Step 5.** Press the **SPAN** key, enter a numerical span using the front-panel keypad, and press the **MHz** key to set the measurement span in MHz.
- Step 6.** Press the **MEASURE** to initiate the spectrum measurement, which is the default measurement for GSM with EDGE.

---

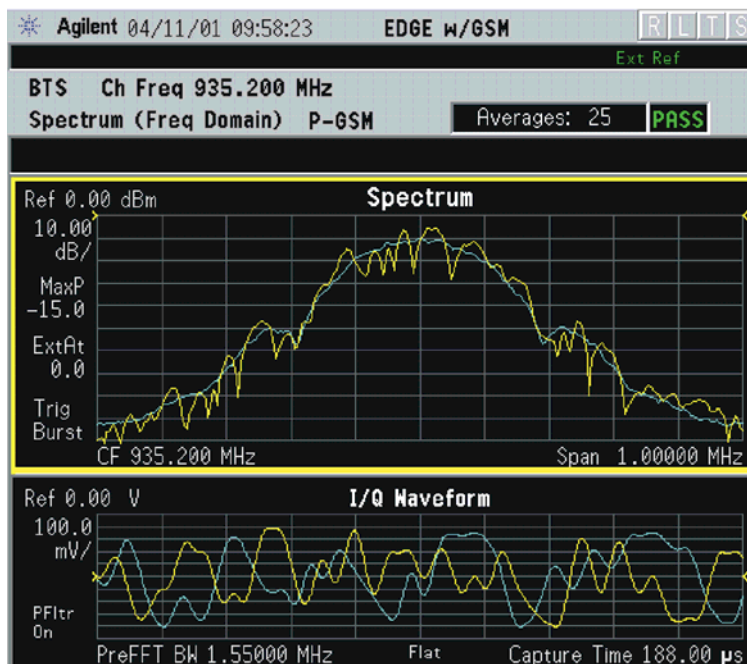
### NOTE

A display with both a **Spectrum window** and an **I/Q Waveform window** will appear when you activate a Spectrum measurement. The active window is outlined in green. Changes to **FREQUENCY, Span, or Amplitude** settings will affect only the active window. Use the **Next Window** key to select a different window, and the **Zoom** key to enlarge a window.

The default display shows both **Current** (yellow trace) and **Average** (blue trace) data. To make viewing the display easier, you can view either the **Current** trace or **Average** separately.

- Press **Trace/View, Trace Display**, and select the trace(s) desired for display.

**Figure 2-45** Spectrum Measurement - Spectrum and I/Q Waveform (Default) View



The spectrum measurement result should look like the above figure. The measurement result values are shown in the summary result window.

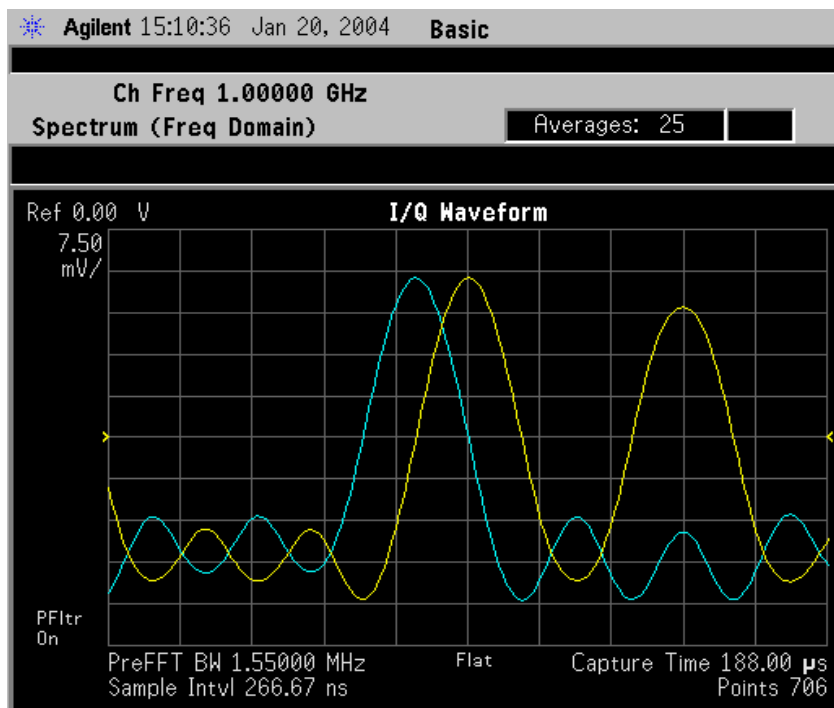
**Step 7.** Press the **View/Trace** key to display a menu allowing selection of another measurement result display including the following:

- **Spectrum** - Provides a combination view of the spectrum graph in parameters of power versus frequency with semi-log graticules, and the I/Q waveform graph in parameters of voltage and time. Changes to frequency span or power will sometimes affect data acquisition. This is equivalent to expanding the selected window with the **Zoom** key.



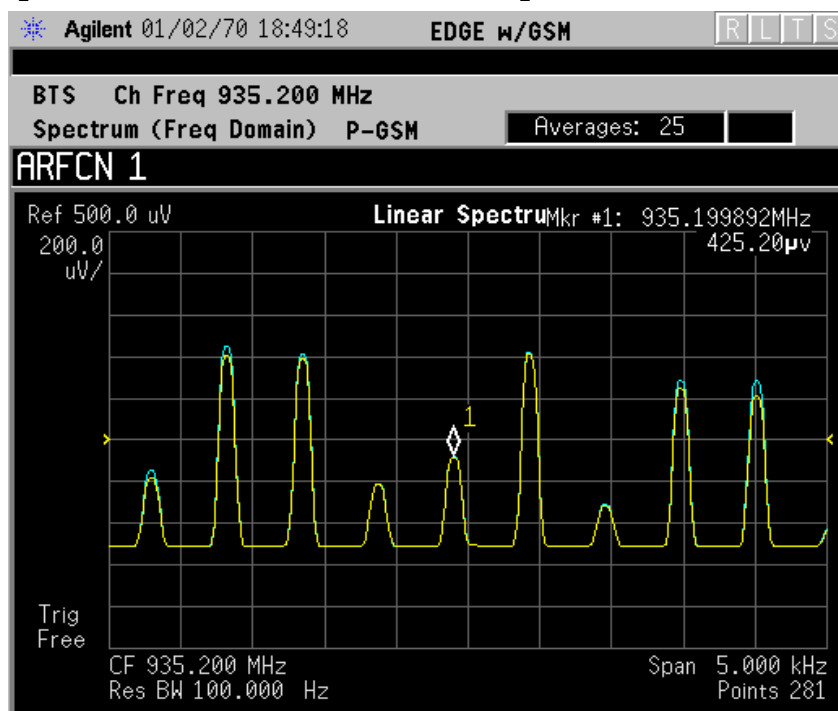
- **Spectrum (Time Domain) I/Q Waveform** - (Key for PSA only) This graph is shown below the **Spectrum** graph in the default dual-window display. **I/Q Waveform** provides a view of the I/Q waveform in parameters of voltage versus time in linear scale. Changes to sweep time or resolution bandwidth can affect data acquisition. Pressing this button is equivalent to pressing the **Next Window** and **Zoom** buttons on the front panel.

**Figure 2-46** Spectrum Measurement - I/Q Waveform (Time Domain) Result (E4406A View)



- **Spectrum Linear** - (for E4406A) Provides a view of the spectrum graph in parameters of voltage versus frequency in linear scale. Changes to frequency span or voltage can affect data acquisition.

**Figure 2-47** Spectrum Measurement - Linear Spectrum View (for E4406A)



\*Meas Setup: View/Trace = Spectrum Linear,  
Span = 5.000 kHz,  
Y Scale/Div = 200  $\mu$ V, Ref Value = 500.0  $\mu$ V,  
Others = Factory default settings

\*Input signals: -20.00 dBm, EDGE pattern data (PN9)

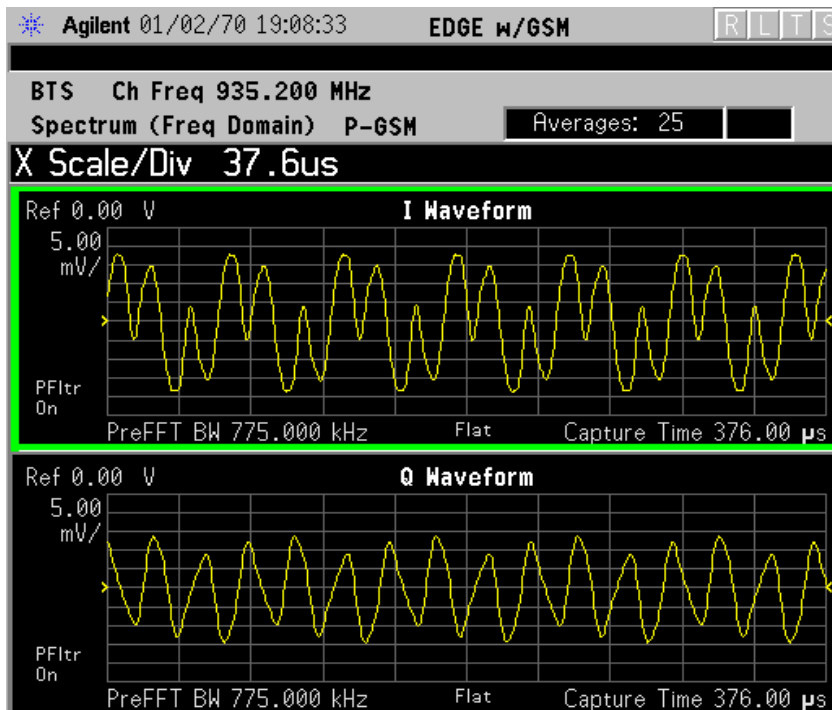
**NOTE**

(for E4406A) For the widest spans, the I/Q window becomes just “ADC time domain samples”, because the I/Q down-conversion is no longer in effect. This is not the case for E4406A Option B7C if the **Input Port** is set to either **I/Q**, **I only**, or **Q only** and you have connected baseband I/Q signals to the **I/Q INPUT** connectors.

- **I and Q Waveform** - (for E4406A) Provides individual views of the I and Q signal waveform windows in parameters of voltage versus time.

To select the I or Q trace view, press the **Next** key at the bottom of the display. The selected window will have a green outline. To view the window full size press the **Zoom** key.

**Figure 2-48 Spectrum Measurement - I and Q Waveform View (for E4406A)**

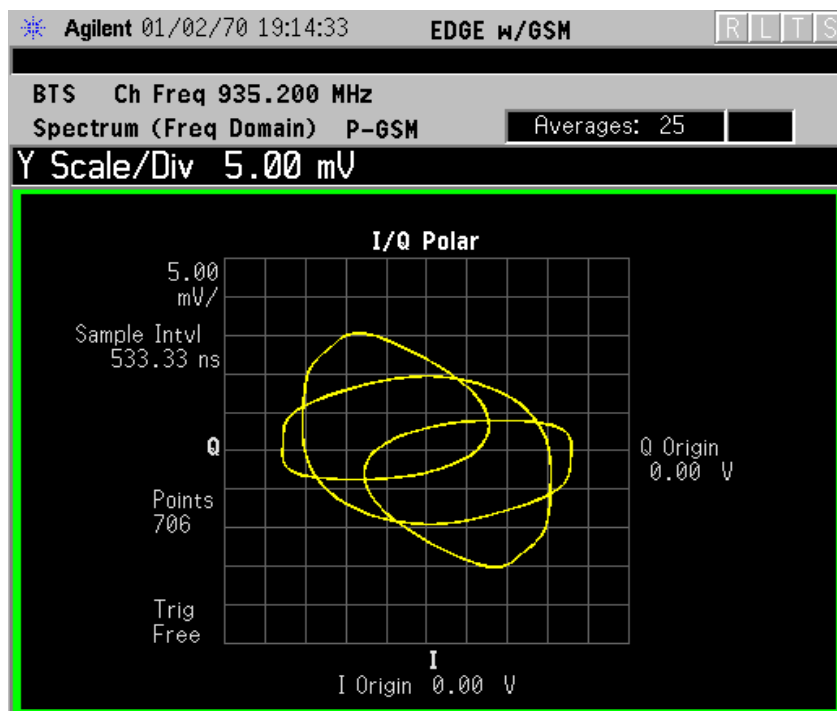


\*Meas Setup: View/Trace = I and Q Waveform  
Span = 500.000 kHz,  
Y Scale/Div = 5.0 mV, Ref Value = 0.0 V,  
Others = Factory default settings

\*Input signals: -20.00 dBm, EDGE pattern data (PN9)

- **I/Q Polar** - (for E4406A) Provides a view of the I/Q signal displayed in a polar vector graph.

**Figure 2-49 Spectrum Measurement - I/Q Polar View (for E4406A)**



\*Meas Setup: View/Trace = I/Q Polar  
Span = 500.000 kHz,  
Y Scale/Div = 5.0 mV, Ref Value = 0.0 V,  
Others = Factory default settings

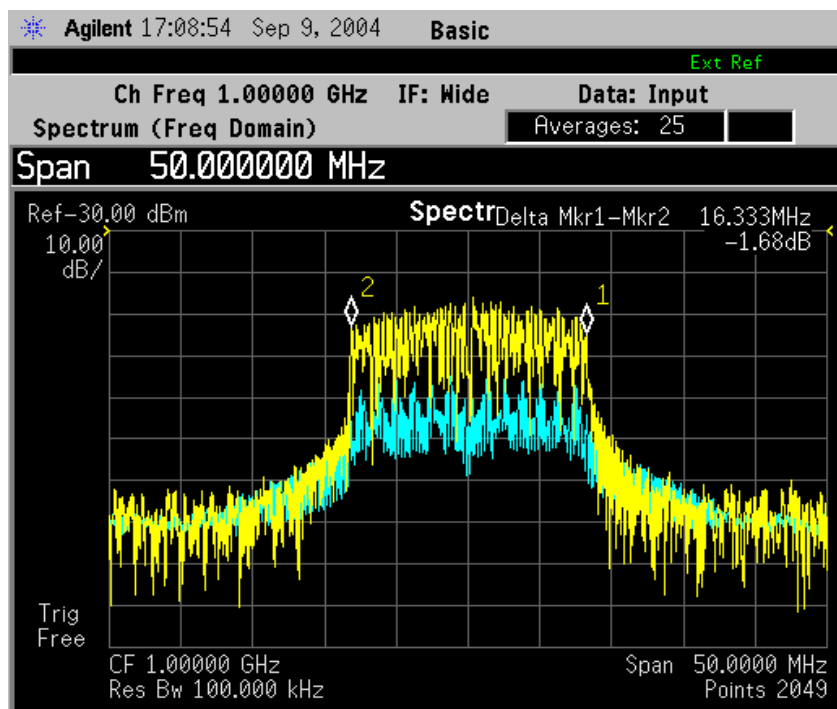
\*Input signals: -20.00 dBm, EDGE pattern data (PN9)

**Step 8.** To make a measurement repeatedly, press **Meas Control**, **Measure** to toggle the setting from **Single** to **Cont**.

- Step 9.** For PSA, if Option 122 is installed, you may use the 80 MHz Bandwidth hardware to view a wideband signal in the Spectrum view.
- Press **SPAN** and select the **Wideband RF Path**. Adjust the span to view up to 80 MHz around your selected center frequency.

The example shown below is a 54 carrier OFDM signal which has a  $-10$  dB bandwidth greater than 16 MHz, with skirts to over twice that bandwidth. Delta markers are shown measuring the peak bandwidth.

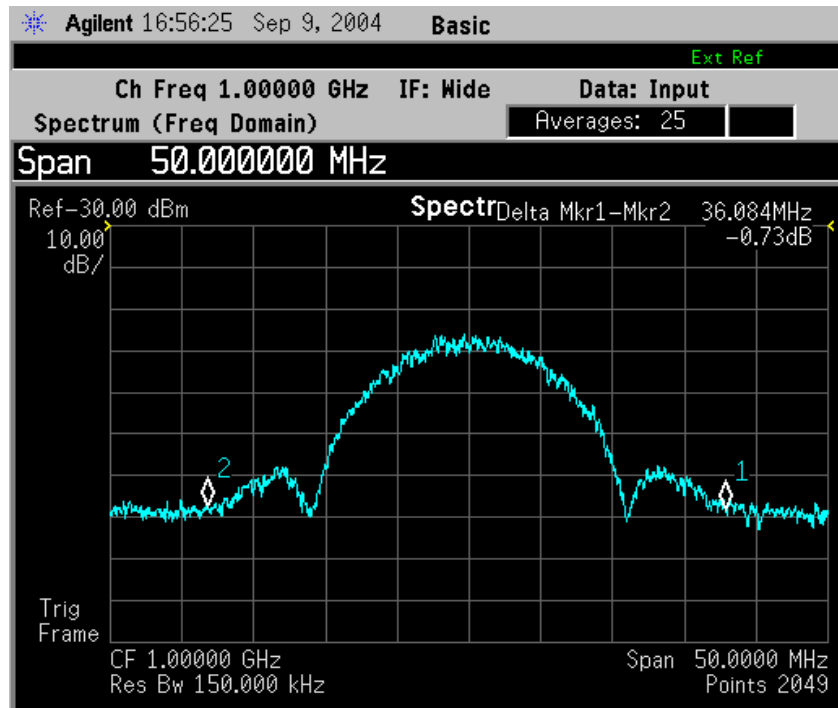
**Figure 2-50** Spectrum Measurement - Spectrum Zoom View with Opt. 122–80 MHz Bandwidth Digitizer Hardware



The example shown below is a 802.11 WLAN signal which has an instantaneous bandwidth of over 36 MHz. Only the Average trace is displayed.

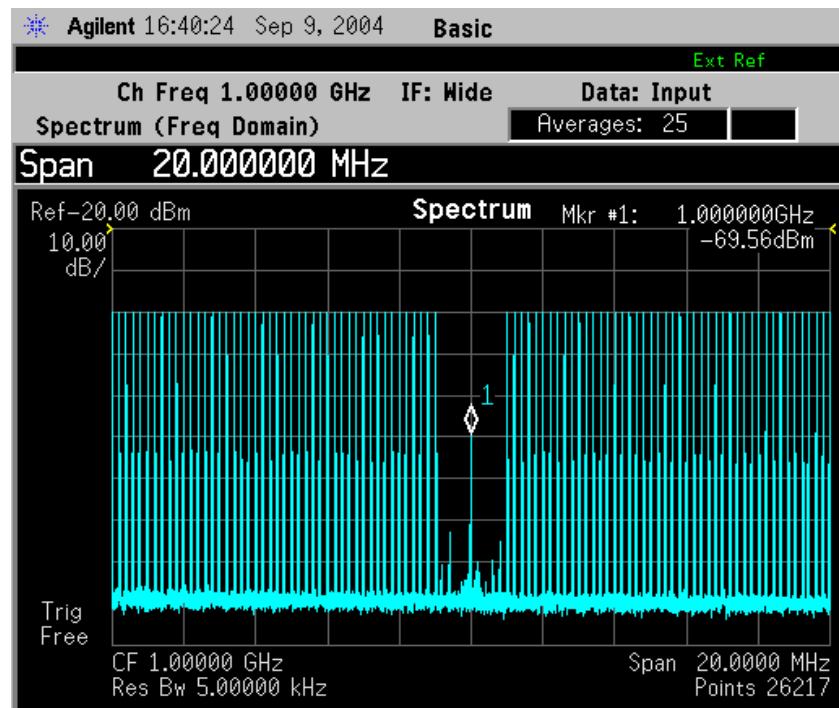
When using the widest spans, the Resolution Bandwidth may be limited by the maximum number of points available for a Spectrum measurement. If your desired setting exceeds the available number of points, the maximum number available will be used, and an error message will be displayed.

**Figure 2-51** Spectrum Measurement - Spectrum Zoom View with Opt. 122–80 MHz Bandwidth Digitizer Hardware



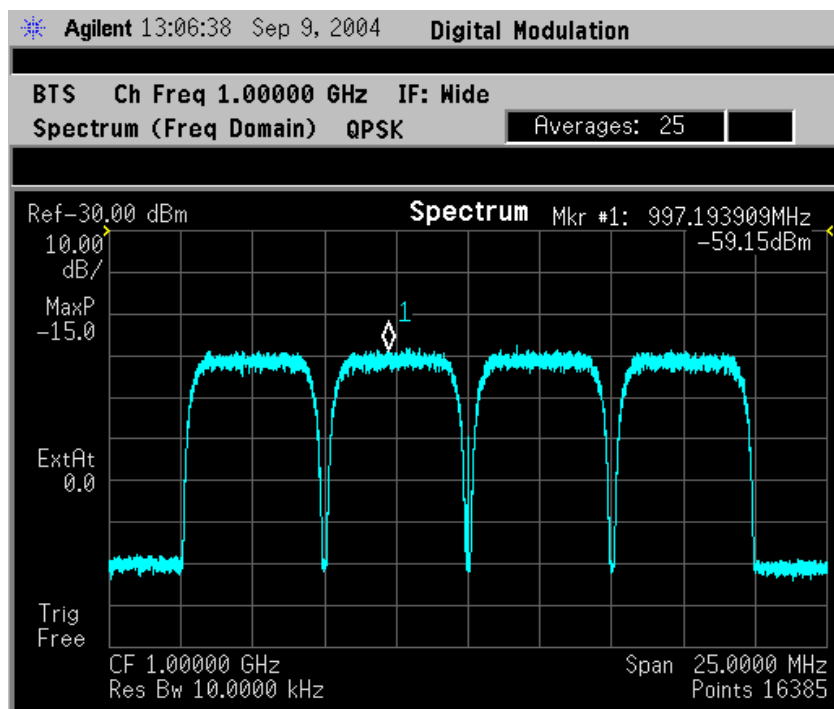
The example shown below is a Spectrum View of the center 20 MHz of a Noise Power Ratio measurement. If you extend the Span to the full 80 MHz bandwidth, individual carriers displayed may merge, as they can be limited by screen resolution and resolution bandwidth. Only the Average data trace is displayed in the example below.

**Figure 2-52** Spectrum Measurement - Spectrum View with Opt. 122– 80 MHz Bandwidth Digitizer Hardware



If you have PSA Option 241, Flexible Digital Modulation Analysis installed, you may use the Spectrum measurement without switching to Basic Mode. Option 241 is also able to utilize the 80 MHz Bandwidth hardware, PSA Option 123. The example shown below is 4 W-CDMA carriers, each occupying 5 MHz of bandwidth. Only the Average trace is displayed.

**Figure 2-53** Spectrum Measurement - Spectrum Zoom View with Opt. 122–80 MHz Bandwidth Digitizer Hardware



**Step 10.** Press the **Meas Setup, More (1 of 2)** keys to check the keys available to change the measurement parameters from the default condition.

For more details about changing measurement parameters, see “[Spectrum \(Frequency Domain\) Measurement Concepts](#)” on page 644

If you have a problem, and get an error message, see “[Interpreting Error Codes](#)” on page 133.



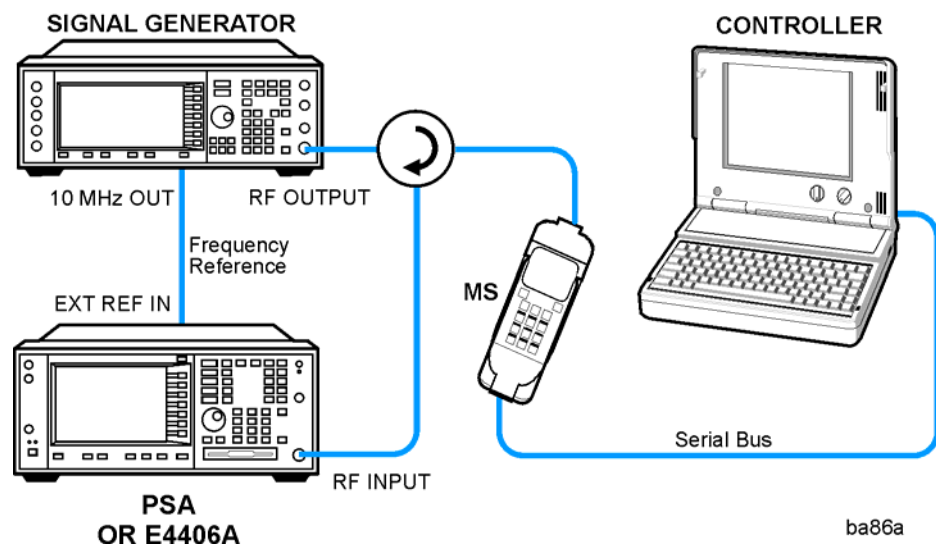
## Transmit Power Measurements

This section explains how to make a Transmit Power measurement on a GSM or EDGE mobile station. This test verifies in-channel power for GSM and EDGE systems. Good measurement results ensure that dynamic power control is optimized, over all system interference is minimized, and mobile station battery life is maximized.

### Configuring the Measurement System

The mobile station (MS) under test has to be set to transmit the RF power remotely through the system controller. This transmitting signal is connected to the instruments RF input port. Connect the equipment as shown.

**Figure 2-54** Transmit Power Measurement System



1. Using the appropriate cables, adapters, and circulator, connect the output signal of the MS to the RF input of the instrument.
2. Connect the base transmission station simulator or signal generator to the MS through a circulator to initiate a link constructed with sync and pilot channels, if required.
3. Connect a BNC cable between the 10 MHz OUT port of the signal generator and the EXT REF IN port of the instrument.
4. Connect the system controller to the MS through the serial bus cable to control the MS operation.

## Setting the MS (Example)

From the base transmission station simulator and the system controller, set up a call using loopback mode for the MS to transmit the RF power as follows:

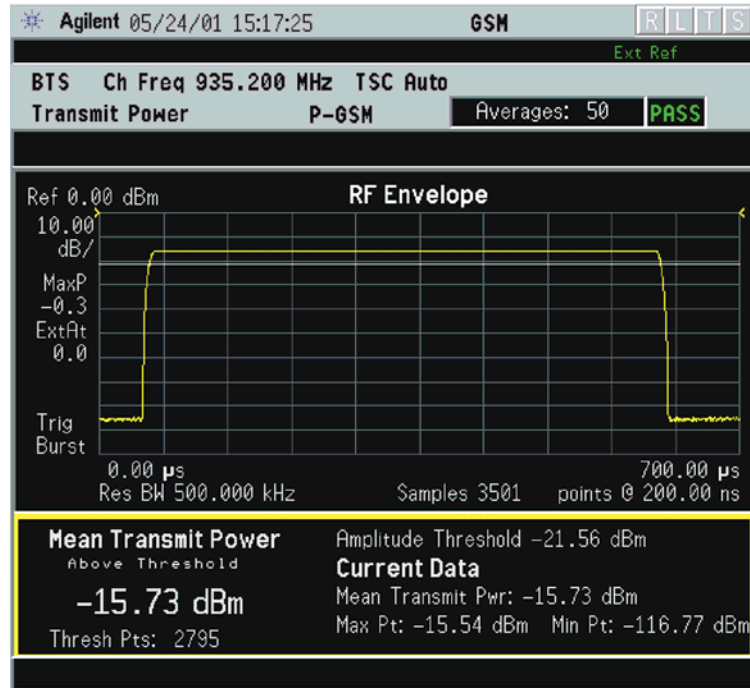
MS:                    Symbol Rate: 270.833kbps  
Frequency:         935.2000 MHz (ARFCN number 1)  
Output Power:     -3 dBW (0.5 W)

## Measurement Procedure

- Step 1.** Press the **Preset** key to preset the instrument.
- Step 2.** Press the **MODE, GSM (w/EDGE)** keys to enable the GSM with EDGE mode measurements.
- Step 3.** Press the **Mode Setup, Trigger** keys to select a trigger source as described in the section titled [“Transmit Power Measurement Keys” on page 228](#).
- Step 4.** Press the **Radio, Device** keys to toggle the device to **MS**.
- Step 5.** Press the **FREQUENCY Channel** key to select the desired center frequency or ARFCN as described in the section titled [“FREQUENCY Channel Key Menu” on page 139](#).
- Step 6.** Press the **Burst Type** key to select the desired burst type as described in the section titled [“FREQUENCY Channel Key Menu” on page 139](#).
- Step 7.** If your signal of interest contains more than 1 Training Sequence, press the **TSC** key, and select a standard Training Sequence (numbered 0-9) to which the measurement will synchronize. The default setting for **TSC** is **Auto**, which will automatically correlate to any one of the standard Training Sequences numbered 0-9. See [“FREQUENCY Channel Key Menu” on page 139](#).

**Step 8.** Press the **MEASURE**, **Transmit Pwr** keys to initiate the Transmit Power measurement.

**Figure 2-55** Transmit Power Result - Single Burst (with data table)

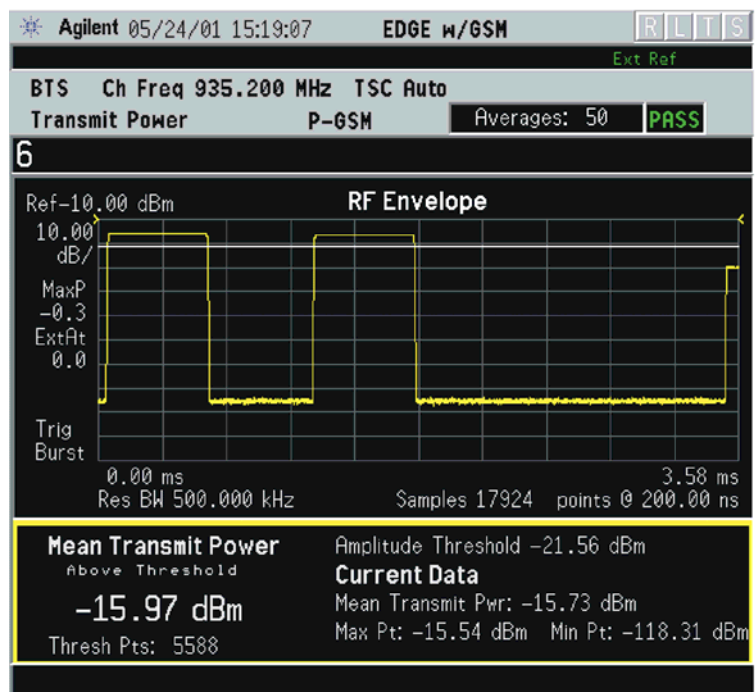


The Transmit Power measurement result display should look the above example, with a time domain display of the burst waveform plotted in dB, and the power measurement values displayed below.

Both the averaged and instantaneous results for Mean Transmit Power are displayed on the screen of the instrument. The Averaged Mean Transmit Power Above Threshold is displayed on the left of the display, while the value of the Mean Transmit Power Above Threshold for the current acquisition is displayed on the right of the screen under the heading Current Data Mean Transmit Pwr. If averaging is turned off, the two values can be the same. When you turn averaging on the Mean Transmit Power Above Threshold is an averaged value.

**Step 9.** To capture multiple bursts press the **Meas Setup**, **More (1 of 2)**, and **Meas Time** keys to extend the measurement period measured and displayed (the default setting is 1 slot).

**Figure 2-56** Transmit Power Result - Multiple Bursts



**Step 10.** Press the **Meas Setup**, **More (1 of 2)** keys to check the keys available to change the measurement parameters from the default condition.

For more details about changing measurement parameters, see [“Transmit Power Measurement Concepts” on page 514](#)

If you have a problem, and get an error message, see [“Interpreting Error Codes” on page 133](#).

## Troubleshooting Hints

Low output power can lead to poor coverage and intermittent service for phone users. Out of specification power measurements indicate a fault usually in the power amplifier circuitry. They can also provide early indication of a fault with the power supply, i.e. the battery in the case of mobile stations.

If you have a problem, and get an error message, see [“Interpreting Error Codes” on page 133](#).

## Waveform (Time Domain) Measurements

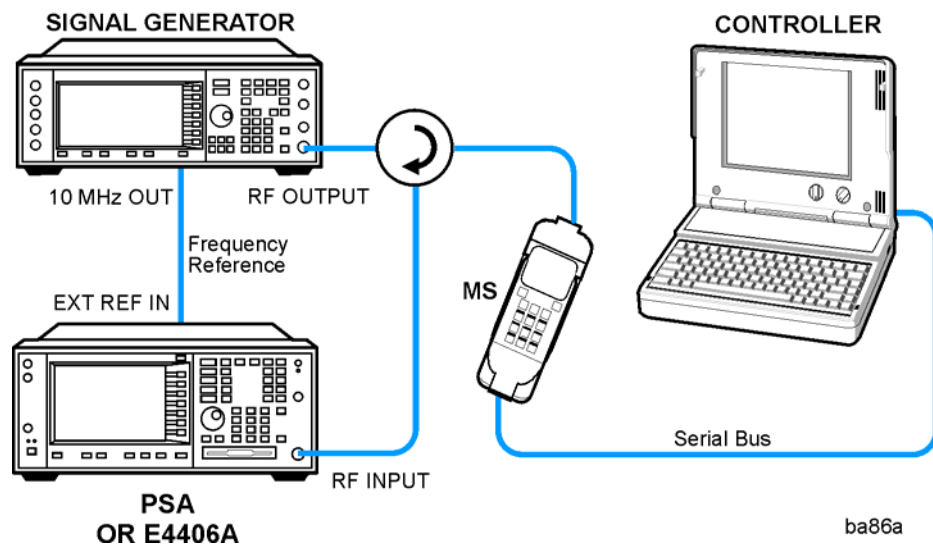
This section explains how to make waveform (time domain) measurement on a GSM with EDGE mobile station. Measurement of I and Q modulated waveforms in the time domain disclose the voltages which comprise the complex modulated waveform of a digital signal.

If installed, you may use PSA Option 122, the 80 MHz Bandwidth Digitizer hardware to perform Waveform measurements of wideband signals using Basic Mode or PSA Option 241, Flexible Digital Modulation Analysis mode.

### Configuring the Measurement System

The mobile station (MS) under test has to be set to transmit the RF power remotely through the system controller. This transmitting signal is connected to the instruments RF input port. Connect the equipment as shown. An interfering or adjacent signal may be supplied as shown.

**Figure 2-57** Waveform Measurement System



1. Using the appropriate cables, adapters, and circulator, connect the output signal of the MS to the RF input of the instrument.
2. Connect the base transmission station simulator or signal generator to the MS through a circulator to initiate a link constructed with sync and pilot channels, if required.
3. Connect a BNC cable between the 10 MHz OUT port of the signal generator and the EXT REF IN port of the instrument.
4. Connect the system controller to the MS through the serial bus cable to control the MS operation.

5. Connect an external trigger, if needed. Press **Mode Setup, Trigger** to access a menu to set up inputs and levels for all triggers. You must then select the appropriate trigger under the **Meas Setup, Trigger** menu to direct the measurement to use your trigger settings.

## Setting the MS

From the base transmission station simulator and the system controller, set up a call using loopback mode for the MS to transmit the RF signal.

## Measurement Procedure

- Step 1.** Press the **Preset** key to preset the instrument.
- Step 2.** Press the **MODE, GSM with EDGE** keys to enable the GSM with EDGE Mode measurements.
- Step 3.** Press the **Mode Setup, Radio, Device** keys to toggle the device to **MS**.
- Step 4.** To set the measurement center frequency press the **FREQUENCY Channel** key, enter a numerical frequency using the front-panel keypad, and complete the entry by selecting a units key, like **MHz**.
- Step 5.** Press the **SPAN** key, enter a numerical span using the front-panel keypad, and press the **MHz** key to set the measurement span in MHz.
- Step 6.** Press the **MEASURE** to initiate the Waveform measurement.

The default display shows both **Current** (yellow trace) and **Average** (blue trace) data. To make viewing the display easier, you can view either the **Current** trace or **Average** separately.

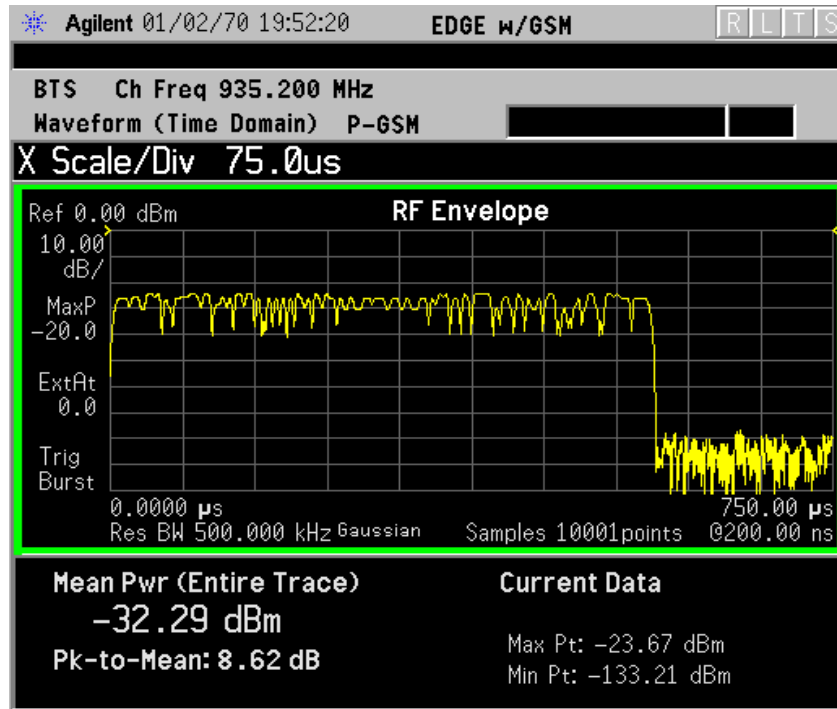
Press **Trace/View, Trace Display**, and select the trace(s) desired for display.

**Step 7.** Press **SPAN X Scale**, and the up or down arrow keys until the waveform is shown at a convenient time scale for viewing.

The next figure shows an example of an RF Envelope (for E4406A) or a Signal Envelope (for PSA) result for a waveform (time domain) measurement. The measured values for the mean power and peak-to-mean power are shown in the text window.

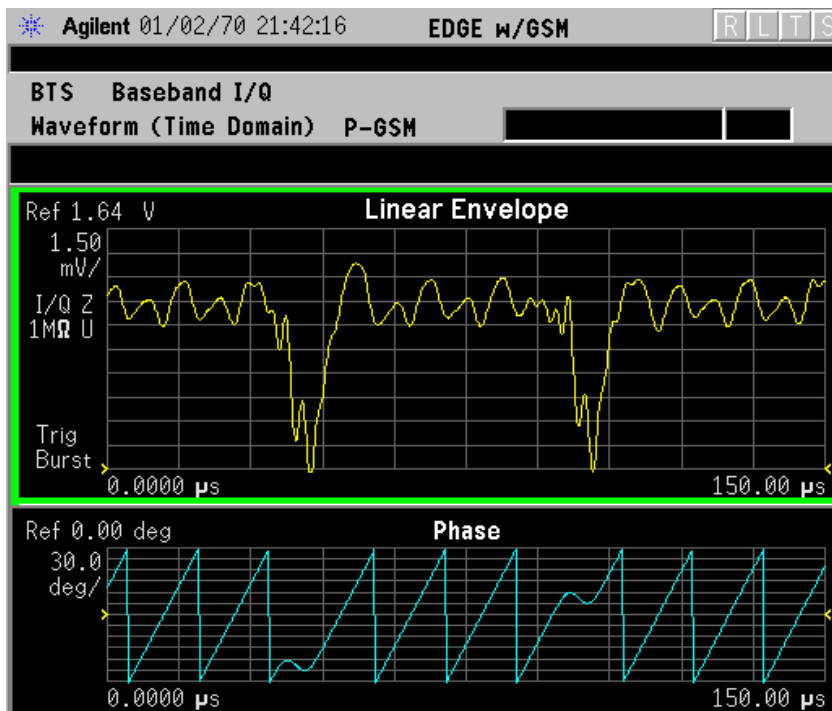
**Figure 2-58**

**Waveform Measurement - RF Envelope (Default View)**



- Step 8.** Press the **Trace/View** (for PSA) or **View/Trace** (for E4406A) key to display the menu allowing selection of the other Waveform views, including the following:
- **Linear Envelope** - (for E4406A Option B7C) Provides a combination view of a linear signal envelope graph and a phase graph with linear graticules. Use the **Next Window** and **Zoom** keys to select and enlarge either graph.

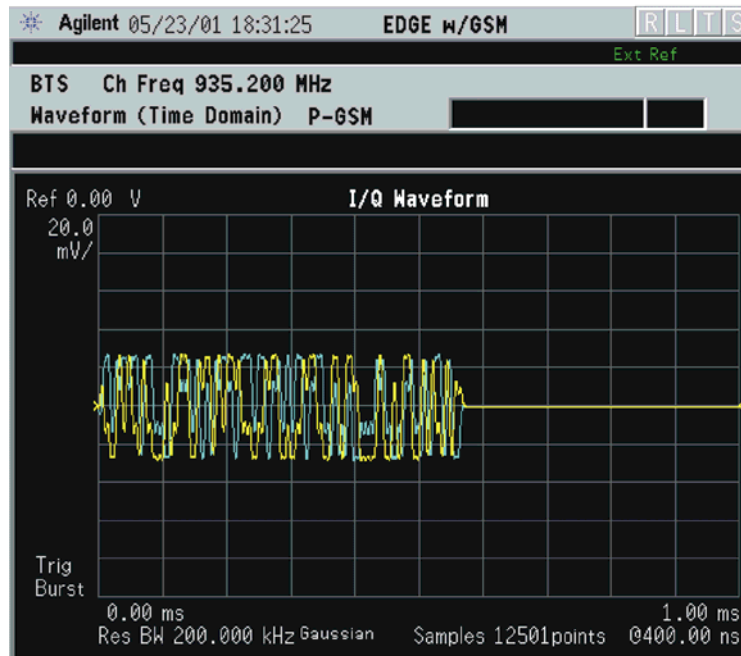
**Figure 2-59** Waveform Measurement - Linear Envelope View





- **I/Q Waveform** - Provides a view of the I and Q waveforms together on the same graph in parameters of voltage versus time in linear scale. Changes to sweep time or resolution bandwidth can affect data acquisition.

**Figure 2-60** Waveform Measurement - I/Q Waveform View

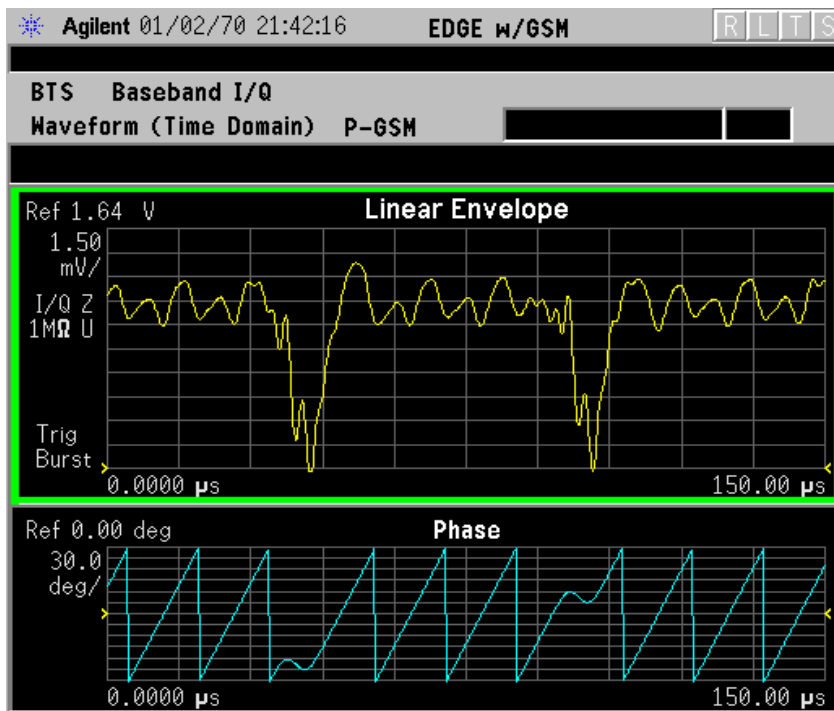


**NOTE**

For the widest spans the I/Q Waveform window becomes just “ADC time domain samples”, because the I/Q down-conversion is no longer in effect.

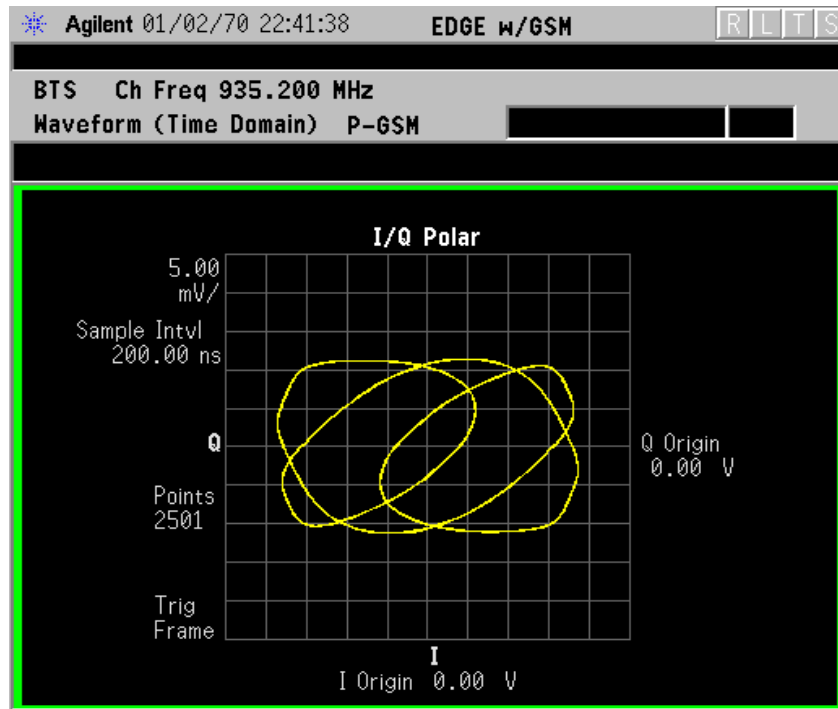
- **I and Q Waveform** - (for E4406A Option B7C) Provides a combination view of the I and Q signal waveform graphs in the linear scales.

**Figure 2-61** Waveform Measurement - I and Q Waveform View



- **I/Q Polar** - (for E4406A) Provides a view of the I/Q signal in a polar vector graph.

**Figure 2-62** Waveform Measurement - I/Q Polar View



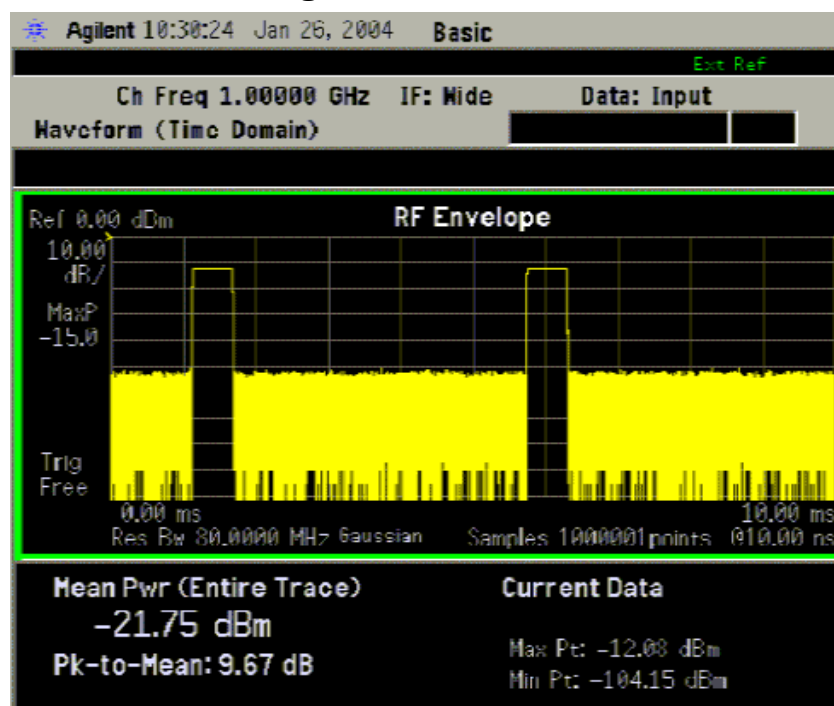
- Step 9.** Press the **AMPLITUDE Y Scale**, and down arrow keys until the waveforms are shown at a convenient voltage scale for viewing.
- Step 10.** Press the **SPAN X Scale**, and down arrow keys until the waveforms are shown at a convenient time scale for viewing.
- Step 11.** Press the **Marker, Trace, and I/Q Waveform** keys to activate a marker. Rotate the RPG knob until the marker is shown at a desired time in the waveform for viewing the trace values at the time position of the marker.

**Step 12.** If PSA Option 122 is installed, you may use the 80 MHz Bandwidth hardware to view a wideband signal in the Waveform view. Even if you are not interested in a wideband signal, using the 80 Mhz IF path provides powerful measurement flexibility, including to the ability to accurately set practically any sample rate and thereby resample waveforms. Resampling, or oversampling, at the correct rate allows you to effectively obtain an integer number of samples per symbol. Make sure that the sample time is aligned with the decision points of the symbols to make analysis of measurement data much easier.

The following example of performing a Wideband IF Waveform measurement of a GSM burst will show the technique to accurately align and resample a signal:

- Press **Mode**, and select **Basic** to be able to use the 80 MHz IF path.
- Press **Measure**, and select the **Waveform** measurement.
- Press **Trace/View** and select the **RF Envelope** view.
- Press **SPAN** and toggle the **IF Path** key to select **Wide**. Adjust the span to view up to 80 MHz around your selected center frequency. Note the example below has 1 million data points.

**Figure 2-63** Waveform Measurement - RF Envelope View with Opt. 122– 80 MHz Bandwidth Digitizer Hardware



- Make sure that your samples are synchronized to the decision points of the signal of interest. In this case we will use the internal Frame Timer to trigger our measurement. A GSM frame is 4.615383 ms long.

Press **Mode Setup**, **Trigger**, select **Frame Timer**, then select **Period**. Enter 4.615383 ms. This only sets the frame timer period. You must direct the measurement to use the Frame Timer in the next step:

Press **Meas Setup**, **Trigger Source** and select **Frame**.

For other measurements, an external trigger may be applied to an External Trigger Input, on either the front or the rear panels. You must specify that trigger selection in this menu.

- In this example, we want to capture an entire GSM burst of 144 symbols (plus guard). A GSM burst is approximately 4.6 ms, so we will set our **Meas Time** to 5 ms:

Press **Meas Setup**, **Meas Time** and enter 5 ms.

- In this resampling example, we want to take exactly 10 samples per GSM symbol. The GSM symbol rate is 270.833 kHz, so we want a sample rate of 2.70833 MHz. Option 122 Wideband IF hardware lets us set the desired sample rate, as follows:  $\text{sample rate} = 5/4 \text{ IF Bandwidth}$ . That means we need set an IF BW of 2.16667 MHz.

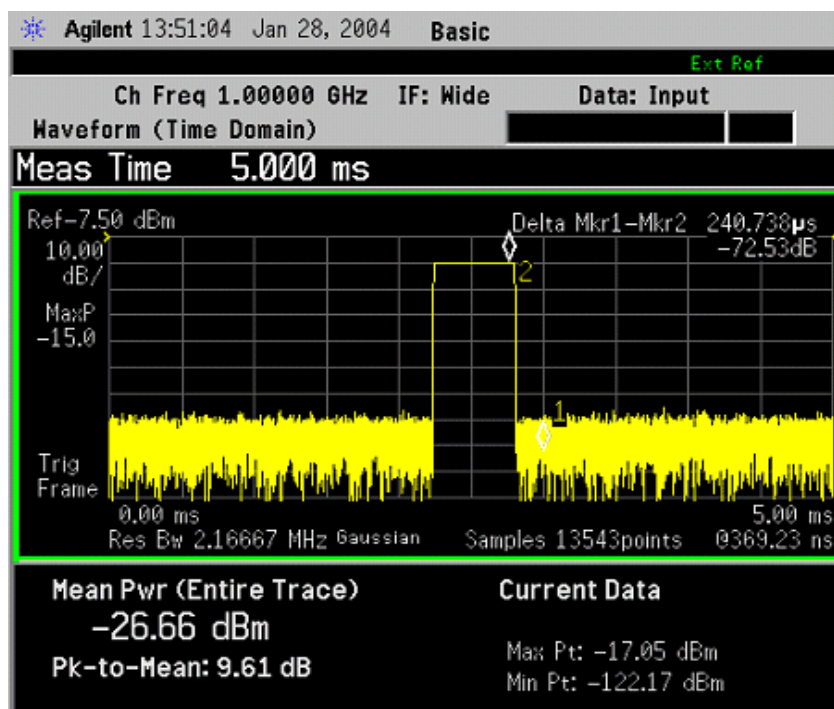
Press **Meas Setup**, **IF BW** and enter 2.16667 MHz.

You can also access the sample rate key directly:

Press **Meas Setup**, **Wideband Setup**, and **Sample Rate** keys. Enter the **Sample Rate** frequency. The **Sample Rate** and **IF BW** settings are coupled. The 5/4 ratio will be preserved regardless of which setting is used.

- Your measurement result should look like Appendix Figure 2-64, “Waveform Measurement - RF Envelope View with Opt. 122- 80 MHz Bandwidth Digitizer Hardware,” on page 126

**Figure 2-64** Waveform Measurement - RF Envelope View with Opt. 122–80 MHz Bandwidth Digitizer Hardware



For more details about making wideband measurements, see the Option 122 section in the Basic Mode Guide.

- Step 13.** To make a measurement repeatedly, press **Meas Control, Measure** to toggle the setting from **Single** to **Cont**.
- Step 14.** Press the **Meas Setup, More (1 of 2)** keys to check the keys available to change the measurement parameters from the default condition.

For more details about changing measurement parameters, see “Waveform (Time Domain) Measurement Concepts” on page 645

If you have a problem, and get an error message, see “Interpreting Error Codes” on page 133.

---

## Using Option B7C Baseband I/Q Inputs

### Baseband I/Q Measurements Available for E4406A VSA Series Transmitter Tester

The following measurements can be made using Baseband I/Q inputs:

- Channel Power
- GSMK Phase and Frequency
- EDGE EVM
- GSM/EDGE Transmit Power
- GSMK PvT
- EDGE PvT
- Power Stat CCDF
- Spectrum (Frequency Domain)
- Waveform (Time Domain)

---

#### NOTE

The following measurements can not be made using Baseband I/Q Inputs:

- ACP
  - GSMK ORFS
  - GSMK Tx Band Spur
  - EDGE ORFS
  - EDGE Tx Band Spur
-

## Baseband I/Q Measurement Overview

Baseband I/Q measurements are similar to RF measurements. To avoid duplication, this section describes only the details unique to using the baseband I/Q inputs. For generic measurement details, refer to the previous “Making Measurements” sections.

To make measurements using baseband I/Q Inputs, make the following selections:

- Select a measurement that supports baseband I/Q inputs. For details see [“Baseband I/Q Measurements Available for E4406A VSA Series Transmitter Tester”](#) on page 127.
- Select the appropriate circuit location and probe(s) for measurements. For details see [“Selecting Input Probes for Baseband Measurements”](#) on page 547.
- Select baseband I/Q input connectors. For details see [“Input/Output Key Menu”](#) on page 148.
- Adjust I/Q Setup if desired. For details see [“I/Q Setup Key Menu”](#) on page 248.
- Select baseband I/Q input impedance. For details see [“I/Q Input Z Key Menu”](#) on page 248.
- Select a baseband I/Q measurement results view. For details see [“Baseband I/Q Measurement Result Examples”](#) on page 129.



## Baseband I/Q Measurement Result Examples

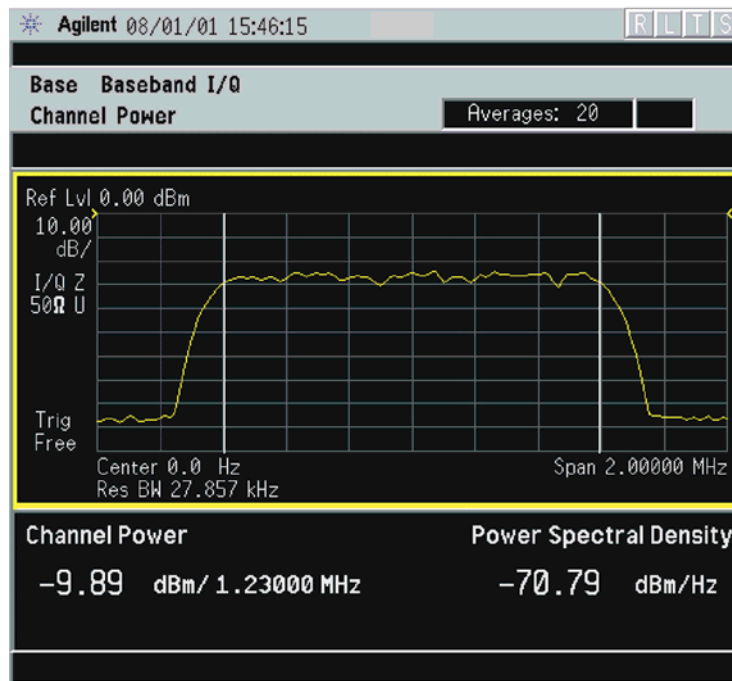
The following are examples of new measurement result displays using baseband I/Q Inputs. A notation below each example indicates the nature of the input signal.

### Channel Power Measurement

There is a new view for Channel Power measurements with baseband I/Q Inputs: the Channel Power Spectrum view with 0 Hz center frequency.

Figure 2-65

### Channel Power - Baseband I/Q Inputs

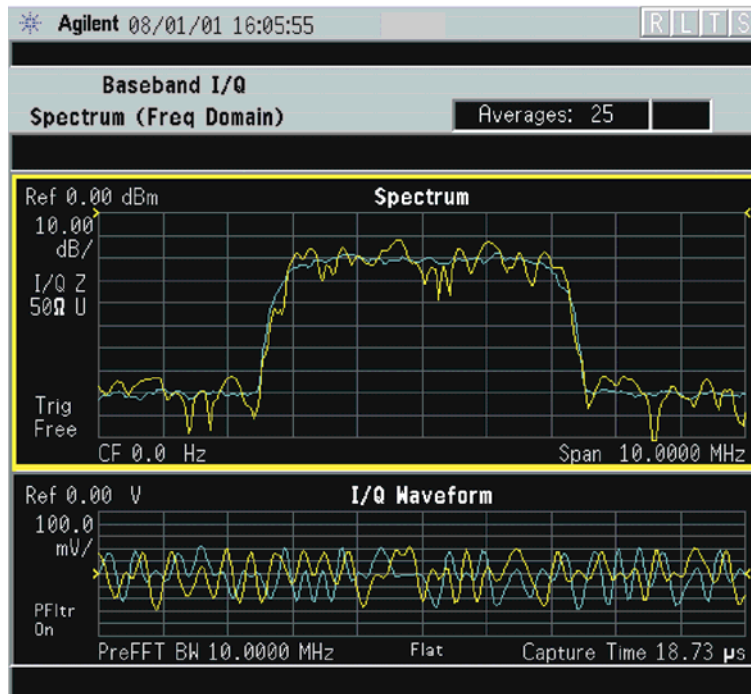


cdma2000 (Rev.8) Downlink, SR1 9 Channel, Baseband I/Q Inputs

### Spectrum (Frequency Domain) Measurement

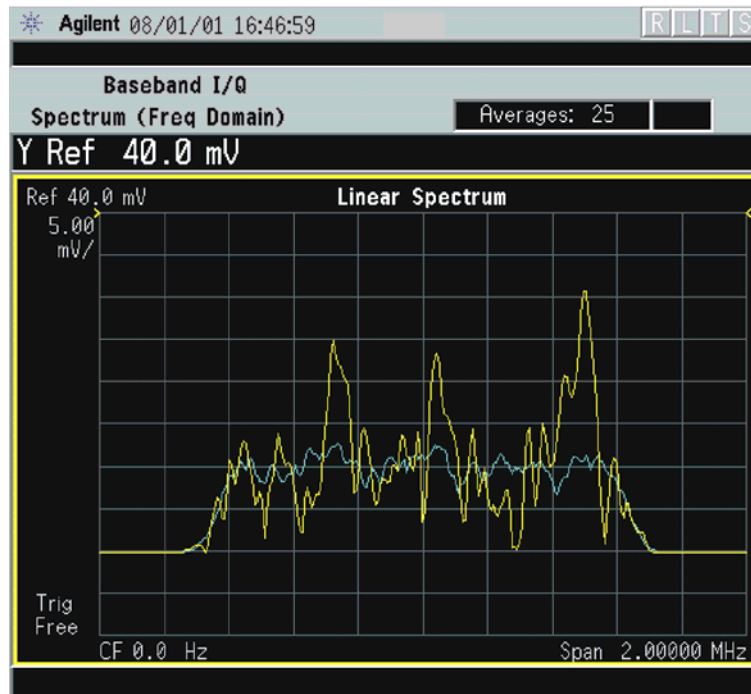
There are two new views with baseband I/Q input Spectrum measurements: the Spectrum view with 0 Hz center frequency, and the Spectrum Linear view with 0 Hz center frequency and the vertical scale in volts.

**Figure 2-66** Spectrum View- Baseband I/Q Inputs



W-CDMA (3GPP 3.4 12-00) Downlink, 1 DCPH, Baseband I/Q Inputs

**Figure 2-67** Spectrum Linear View- Baseband I/Q Inputs



W-CDMA (3GPP 3.4 12-00) Downlink, 1 DCPH, Baseband I/Q Inputs

### Waveform (Time Domain) Measurement

There are two new views with baseband I/Q input Waveform (Time Domain) measurements: the Linear Envelope view with the vertical scale in volts, and the I and Q Waveform view with separate windows for the I and Q traces.

Figure 2-68

Waveform Linear Envelope - Baseband I/Q Inputs

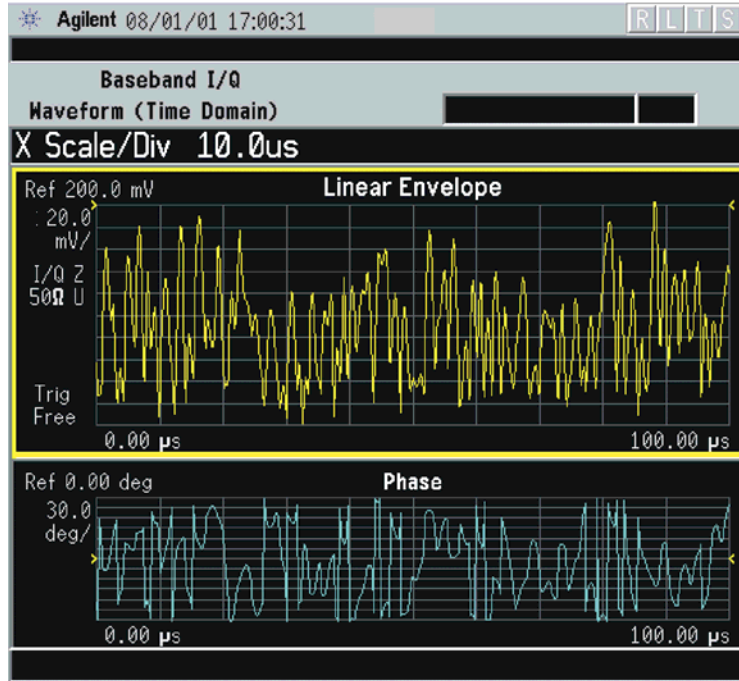
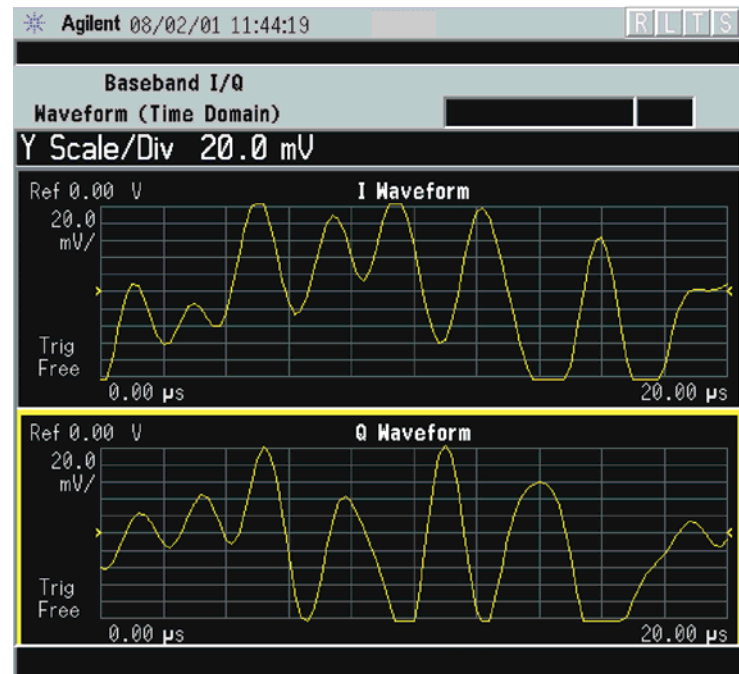


Figure 2-69

I and Q Waveform View - Baseband I/Q Inputs



## Using Basic Mode

Basic mode is a standard feature of E4406A Transmitter Testers, and is part of Option B7J for the PSA Series Spectrum Analyzers. Basic mode is *not* related to a particular communications standard. That is, it does not default to measurement settings that are for any specific standard. You may want to use Basic Mode if you are making measurements on a signal that is not based on a specific digital communications standard.

### Basic Mode in E4406A VSA Series Transmitter Testers

There are five generic measurements available under the **MEASURE** key in Basic mode:

- Adjacent Channel Power (ACP)
- Channel Power
- Power Statistics CCDF
- Spectrum measurement (frequency domain).
- Waveform measurement (time domain)

The ACP, Channel Power, and Power Stat CCDF measurements are fully described in the VSA Series User's Guide. Please refer to that manual for complete information on these measurements.

### Spectrum and Waveform Measurements

These measurements provide a spectrum measurement mode that is similar to a standard spectrum analyzer, and a waveform measurement mode that is similar to a microwave oscilloscope. Unlike those standard analyzers, these measurements are optimized for digitally modulated signals, so they can be used to output the measured I/Q data.

For your convenience, Spectrum and Waveform measurements are also available in this mode, with the same functionality, so you can refer to the sections included in this chapter for information about using them.

### Basic Mode in PSA Series Spectrum Analyzers

There are two generic measurements available under the **MEASURE** key in Basic mode:

- Spectrum measurement (frequency domain).
- Waveform measurement (time domain)

These Spectrum and Waveform measurements are also available in this mode, with the same functionality, so you can refer to the sections included in this chapter for information about using them.

## Interpreting Error Codes

During the execution of your measurement you may encounter problems which generate error codes. Referring to the following common errors may be helpful.

If **ERR** is shown in the annunciator bar, press the **System, Show Errors** hard and soft keys to read the detailed error information.

- **Measurement Instability- Low Input Signal Level**

If the input signal level is too low to make a valid measurement no code domain power will be displayed in the **Power** graph window. In this situation, no error message can be displayed to indicate the nature of the fault. If you cannot increase the power into the tester, you need to increase the input sensitivity by adjusting the **ADC** range.

Press **Meas Setup, More (1 of 3), More (2 of 3), Advanced, ADC Range**, and then **Manual** keys. Increase the setting from the  $-6$  dB (for E4406A) or **None** (for PSA) default to  $6$  dB, for example. Another option is to use the **Auto** setting (the **Auto** setting is not used as the default to improve measurement speed).

Press **Restart** to make another measurement and observe the results. Re-adjust the **ADC** as necessary to obtain a valid measurement.

- **Error Code 16 “Input overload”**

This error means that your measurement has erroneous results due to the excessive input power level. To correct this condition, the input signal level must be reduced by using the internal and/or external attenuators.

Press the **Mode Setup, Input, Input Atten** keys to enter an attenuation value to reduce the transmitted power from the **MS**. This allowable range is up to  $40$  dB.

If you want to attenuate more than  $40$  dB, connect your external attenuator between the **RF INPUT** port and the **DUT**. Be sure to add its attenuation value to the readings of the measurement result.

To automate this calculation, press the **Mode Setup, Input, Ext Atten** keys to enter the additional attenuation value. The allowable range is up to  $100$  dB. The power readings of the measurement will take into account the external attenuation value.

- **Error Code 601 “Signal too noisy”**

This error means that your input signal is too noisy to capture the correct **I/Q** components. To make a more stable measurement the trigger source may need to be set to **Frame**, for example.

- **Error Code 604 “Can not correlate to input signal”**

This error means that the tester has failed to find any active channels in the input signal as specified. To improve the correlation some critical parameter needs to be adjusted, like the input signal level or scramble code, for example.

For more details consult the chapter in this book dedicated to the measurement in question, or see the “Instrument Messages and Functional Tests” manual.

---

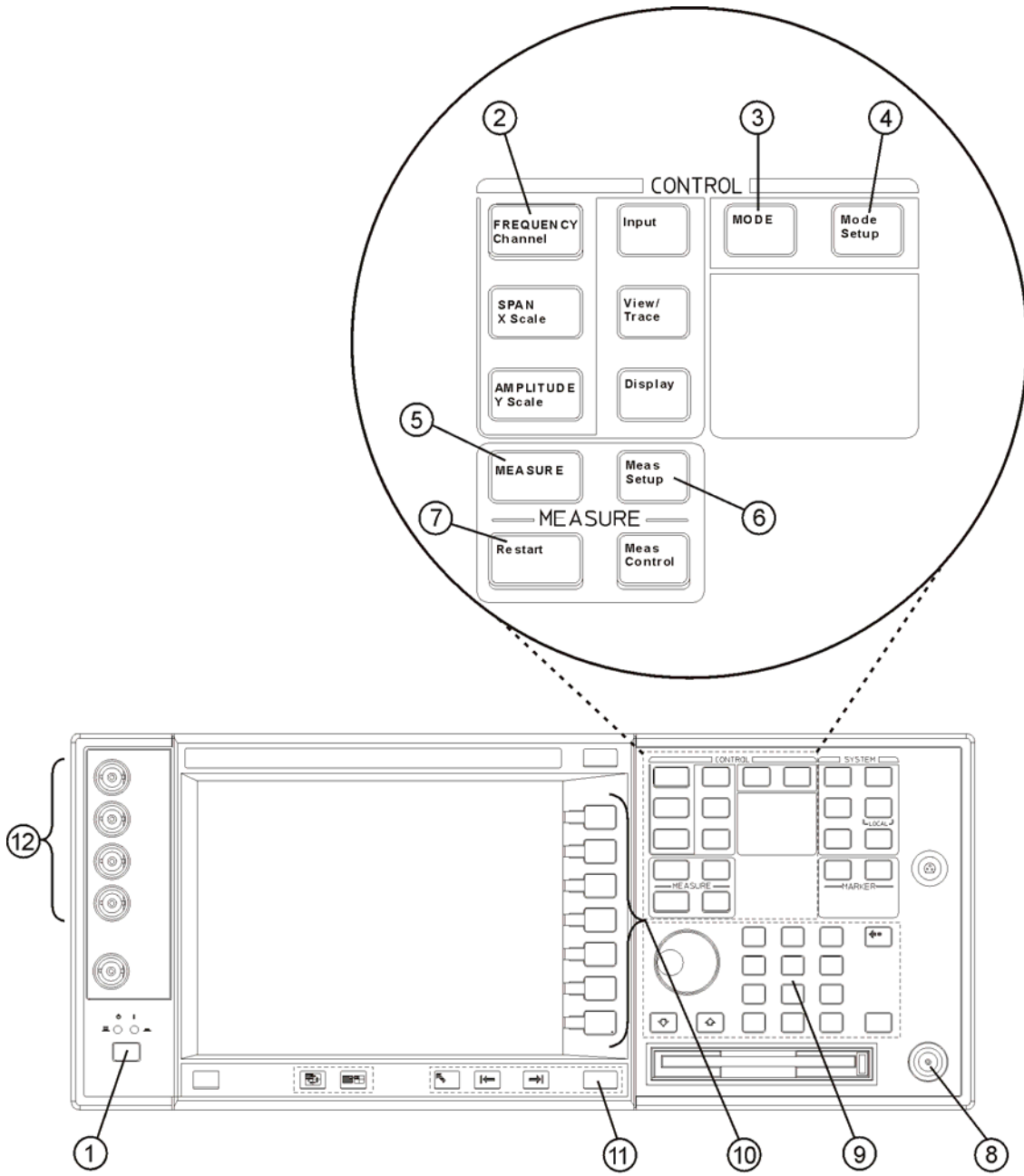
## 3 Key Reference

This chapter provides detailed descriptions of the keys used to set up and make GSM and EDGE measurements, including **Mode Setup**, **Meas Setup**, and **MEASURE**. Keys that allow you to see different presentations of the measurement results are also described, including **Trace/View**, and **Display**, showing the associated screens.

## Instrument Front Panel Highlights

The most commonly used function keys on the VSA and PSA front panels are located as shown in the illustrations below. The operation of the keys is briefly explained on the following page. Refer to your User's Guide for complete details on all keys.

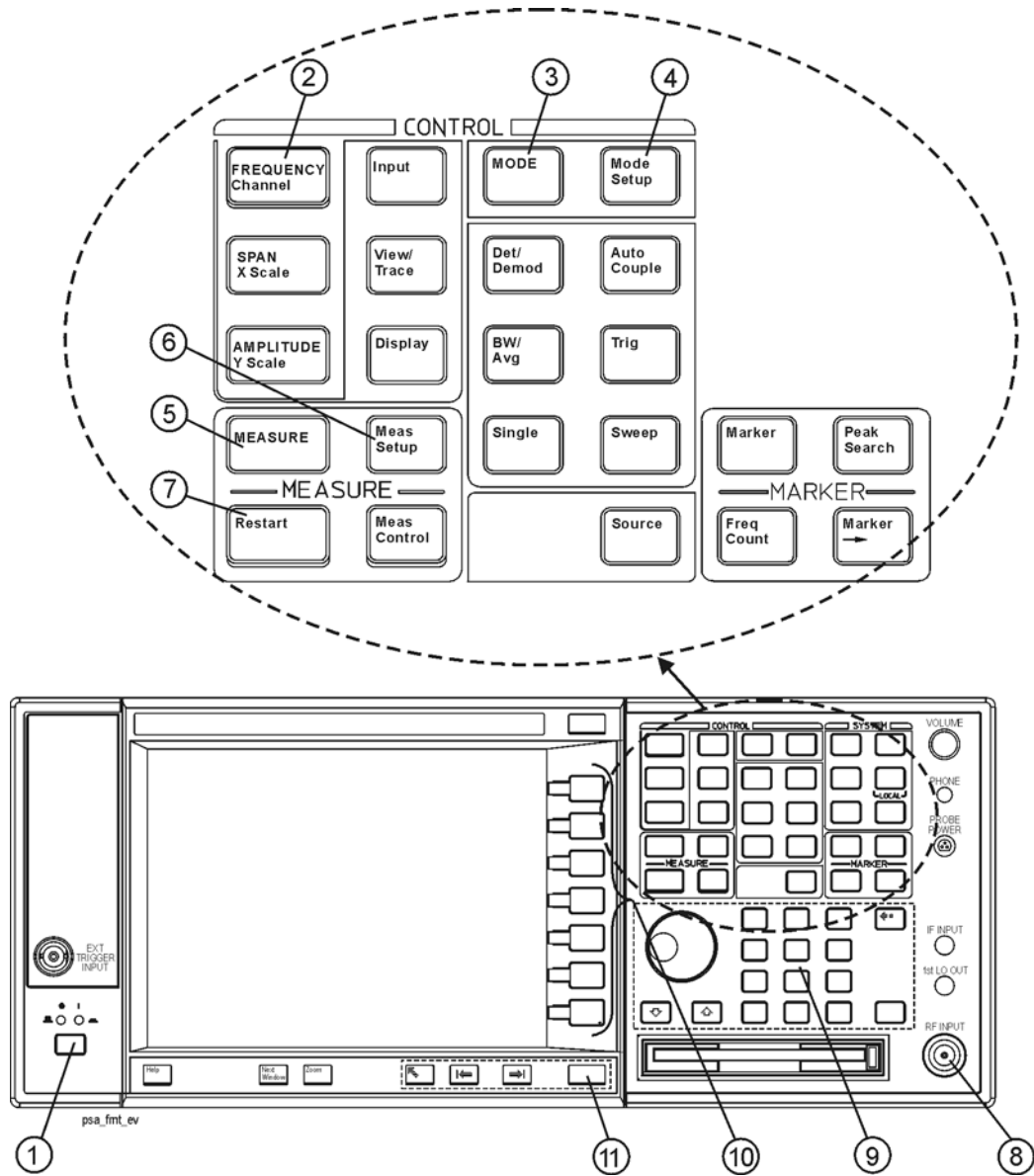
**Figure 3-1 E4406A Selected Front Panel Key Locations**



aa81a



**Figure 3-2** PSA Selected Front Panel Key Locations



Key Reference  
Instrument Front Panel Highlights

1. The **On/Off** switch toggles the power between on and off. A green LED will light when the instrument has been turned on. When energized in the standby mode a yellow LED is lit above the **On/Off** switch.
2. **FREQUENCY Channel** accesses the softkey that controls the center frequency or channel number. These parameters apply to all measurements in the current mode.
3. **MODE** accesses the softkey menu to select one of the radio systems installed in the instrument. Each mode is independent from all other modes.
4. **Mode Setup** accesses softkeys that affect parameters that are specific to the current mode and affect all measurements within that mode.
5. **MEASURE** accesses the menus to initiate one of the various measurements that are specific to the current mode.
6. **Meas Setup** accesses the menus of test parameters that are specific to the current measurement.
7. **Restart** causes the measurement, of which process is currently halted, to start again from the initial process according to the current measurement setup parameters.
8. The **RF INPUT** port allows you to apply an external RF signal.
9. The **Data Entry** keypad is used to enter numeric values to parameters. A value from this keypad will be displayed in the active function area of the screen, then the value will become valid for the current measurement upon pressing the **Enter** key or selecting a unit of measurement depending on the parameter.
10. The **Softkeys** allow you either to activate a feature or to access a further softkey menu. An arrow on the right side of a softkey label indicates that the key has a further selection menu. The active softkey is highlighted, however, grayed-out keys are currently unavailable for use or are only to show information. If a softkey menu has multiple pages, further pages will be accessed by pressing the **More** key which is placed at the bottom of a menu.
11. **Return** allows you to exit from the current menu and display the previous menu. If you are on the first page of a multiple-page menu (the menu with **More (1 of 3)** for example), the **Return** key will exit from that menu. When you activate another measurement, the return list is cleared. The **Return** key will not return you to the previously activated mode, nor will it alter any values you have entered on previous menus.
12. Baseband I/Q Inputs (E4406A Option B7C) allow you to analyze signals at baseband frequencies. See [“Using Option B7C Baseband I/Q Inputs” on page 127](#).

## Front Panel Keys

**NOTE** Only front panel keys affected by selection of GSM or GSM and EDGE mode are described here. For a complete description of all front panel keys see the E4406A VSA or PSA Series User's Guide.

### FREQUENCY Channel Key Menu

Key Path: **FREQUENCY Channel**

**NOTE** After selecting the desired mode setup, you will need to select the desired ARFCN, center frequency, BMT frequency, burst type, and TSC (Training Sequence Code). The selections made here will apply to all measurements in the mode.

**Frequency Channel menu:**

- **ARFCN**

Allows you to select the desired RF channel to be measured. Refer to the table below for the ARFCN range for a specific GSM band.

- **Center Freq**

This is the current instrument center frequency. Use this key to input a frequency that corresponds to the desired RF channel to be measured.

- **BMT Freq**

Allows you to select the Bottom, Middle, or Top frequencies of the GSM selected radio band to be measured. This will automatically select a specific center frequency and ARFCN. Refer to the following table.

Band	Tx Band Edge (MHz)		BOTTOM		MIDDLE		TOP	
	Low	High	Freq (MHz)	ARFC N	Freq (MHz)	ARFC N	Freq (MHz)	ARFC N
P-GSM	935	960	935.200	1	947.600	63	959.800	124
E-GSM	925	960	925.200	975	942.600	38	959.800	124
R-GSM	921	960	921.200	955	940.600	28	959.800	124

Band	Tx Band Edge (MHz)		BOTTOM		MIDDLE		TOP	
	Low	High	Freq (MHz)	ARFC N	Freq (MHz)	ARFC N	Freq (MHz)	ARFC N
DCS 1800	1805	1880	1805.20	512	1842.60	699	1879.80	885
PCS 1900	1930	1990	1930.20	512	1960.00	661	1989.80	810
GSM 450	460.4	467.6	460.600	259	464.000	276	467.400	293
GSM 480	488.8	496.0	489.000	306	492.400	323	495.800	340
GSM 700	747	762	747.2	438	754.6	475	761.8	511
GSM 850	869	894	869.200	128	881.600	190	893.800	251

- **Timeslot**

Selects which one of the 8 time slots in a frame is active (timeslot 0 is the default, both when set to On and when set to Off). Timeslot is available when **Burst Sync** is either **Training Sequence** or **RF Amptd**; otherwise it is unavailable (greyed out).

The timeslots are determined by taking the acquired data and dividing it into timeslots 0 to 7. An active timeslot burst must be within approximately 25% of the expected timeslot position, otherwise the instrument may think the burst is an adjacent timeslot and may not detect it. The trigger delay can be used to position the signal if it is not aligned in the timeslots as desired.

- **Burst Type**

Choose an EDGE or GSM burst type from the following selections:

- **Normal (TCH & CCH)** - Burst length = 142 symbols  
This is the default setting for EDGE (with GSM), and should be used for all EDGE burst measurements.
- **Sync (SCH)** - Burst length = 142 symbols  
Use of this Burst Type is usually associated with GSM measurements.
- **Access (RACH)** - Burst length = 88 symbols  
Use of this Burst Type is usually associated with GSM measurements.

- **TSC**

Allows you to select the Training Sequence Code that determines which burst is to be measured. This key will be unavailable (grayed

out) if a burst type other than **Normal** is selected, indicating the standard TSC is used corresponding to the burst type. **Burst Sync** must be set to **Training Sequence**.

- **Auto** - In auto, the measurement is made on the first burst found to have any one of the valid TSCs in the range of 0 to 7. The measurement may be made on various timeslots if more than one timeslot has one of the 8 valid TSCs.
- **Man** - In manual, the measurement is made on the first burst found to have the selected TSC. TSC numbers in the range of 0 to 7 can be selected. The measurement may be made on various timeslots if more than one timeslot has this same TSC.

### Frequency Channel Defaults

When the EDGE (with GSM) or GSM w/EDGE mode is selected, the instrument will default to the following settings.

**Table 3-1**

Function	Factory Default Setting
ARFCN	1
Center Frequency	935.200 MHz
Timeslot	0 Off
Burst Type	Normal (TCH & CCH)
TSC (Std)	0 Auto

## Measurement Control Key Menu

Key Path: **Meas Control**

**Meas Control** Key menu:

- **Measure** softkey. Press **Meas Control**, **Measure** to toggle between Single and Cont (for continuous) measurement states (This is not the same as the front panel **MEASURE** key which is used to select measurements). When set to Single, the measurement will continue until it has reached the specified number of averages set by the average counter. When set to Continuous, the measurement will run continuously, and perform averaging according to the current average type (repeat or exponential). The default setting is continuous.
- **Pause** key. Press **Meas Control**, **Pause** to pause the current measurement. Once toggled, the label of the **Pause** key changes to read **Resume**. The **Resume** key, once pressed, continues the active measurement from the point at which it was paused.
- **Restart** key. The **Restart** front panel key repeats the current measurement from the beginning, while retaining the current measurement settings.

## MODE Key Menu

Key Path: **MODE**

### For PSA:

To access the measurement personality that includes EDGE and GSM, press the **MODE** key and select the **GSM w/EDGE** key.

### For E4406A:

To access the GSM measurement personality, press the **MODE** key and select the **GSM** key.

To access the measurement personality that includes EDGE and GSM, press the **MODE** key and select the **EDGE w/GSM** key.

---

**NOTE**

Mode settings are persistent. When you switch from one mode to another mode, the settings you have chosen for the modes will remain active until you change them. This allows you to switch back and forth between modes without having to reset settings each time. Presetting the instrument or powering the instrument off and on will return all mode settings to their default values.

---

## Mode Setup Key Menu

Key Path: **Mode Setup**

- **Radio** key menu:
  - **Band** - Select the GSM band (P-GSM, E-GSM, R-GSM, GSM 450, GSM 480, GSM 700, GSM 850, DCS 1800, or PCS 1900). Refer to the table in the previous section for GSM band data.
  - **Device** - Select the device to test BTS (Base Transceiver Station) or MS (Mobile Station).
  - **BTS Type** - Select the type of BTS (Base Transceiver Station) to be tested (Normal, Micro1, Micro2, Micro3, or Pico).
  - **Freq Hopping** - Turn frequency hopping on or off. If frequency hopping is turned on, the instrument will ignore the bursts when the frequency is hopped off the selected channel frequency. Thus only valid data is included in the results. Only the Power vs. Time, EDGE EVM, and Phase and Frequency Error measurements can be made on hopping GSM signals.
  - **Carrier** - Select the type of carrier to measure (Burst or Continuous). Most standards based measurements use a burst carrier. A continuous carrier may be used for measurement of GSM Phase and Frequency Error, and may be suitable for other non-standards based measurement needs. See “GMSK Phase and Frequency Error Measurement Concepts” on page 521.

**Table 3-2**

Radio Default Settings	
Band	P-GSM
Device	BTS
BTS Type	Normal
Freq Hopping	Off
Carrier	Burst

- **Input** key menu:  
Key Path: **Mode Setup, Input**

---

**NOTE** You can also access the **Input** key menu from the **Input/Output** front-panel key. For details of **Input/Output** key see [“Input/Output Key Menu” on page 148](#).

---

- **Trigger** key menu:

---

**NOTE** These menus are used to set Trigger parameters only. The actual trigger source is selected separately for each measurement under the **Meas Setup** key.

---

— **RF Burst**

**Delay** - For trigger delay use positive values. For pre-trigger use negative values.

**Level** - For the **RF Burst** selection, the level is relative to the peak level of the RF signal. For the **Video** selection, the level is the value, in dBm at the RF input, that will cause the trigger. For the **Ext Front** and **Ext Rear** selections, the level range is -5 to +5 volts.

**Slope Pos Neg** - Choose to trigger off of the leading edge (**Pos**) or the trailing edge (**Neg**) of the burst.

— **Video (Envlp)**

**Delay** - For trigger delay use positive values. For pre-trigger use negative values.

**Level** - For the **RF Burst** selection, the level is relative to the peak level of the RF signal. For the **Video** selection, the level is the value, in dBm at the RF input, that will cause the trigger. For the **Ext Front** and **Ext Rear** selections, the level range is -5 to +5 volts.

**Slope Pos Neg** - Choose to trigger off of the leading edge (**Pos**) or the trailing edge (**Neg**) of the burst.

— **Ext Front**

**Delay** - For trigger delay use positive values. For pre-trigger use negative values.

**Level** - For the **RF Burst** selection, the level is relative to the peak level of the RF signal. For the **Video** selection, the level is the value, in dBm at the RF input, that will cause the trigger. For the **Ext Front** and **Ext Rear** selections, the level range is -5 to +5 volts.



**Slope Pos Neg** - Choose to trigger off of the leading edge (**Pos**) or the trailing edge (**Neg**) of the burst.

— **Ext Rear**

**Delay** - For trigger delay use positive values. For pre-trigger use negative values.

**Level** - For the **RF Burst** selection, the level is relative to the peak level of the RF signal. For the **Video** selection, the level is the value, in dBm at the RF input, that will cause the trigger. For the **Ext Front** and **Ext Rear** selections, the level range is -5 to +5 volts.

**Slope Pos Neg** - Choose to trigger off of the leading edge (**Pos**) or the trailing edge (**Neg**) of the burst.

— **Trig Holdoff** - Sets the period of time before the next trigger can occur.

— **Auto Trig** - Acts as a trigger time-out. If no trigger occurs by the specified time, a trigger is automatically generated.

— **Frame Timer** - Accesses the menu to manually control the frame timer:

**Period** - Sets the period of the frame clock. The default is 4.615385  $\mu$ s (1 GSM frame).

**Offset** - Sets a one-time phase adjustment of the frame clock.

**Reset Offset** - Resets the display of offset key to 0.

**Sync Source** - Selects the source used to sync the frame timer (Ext Front, Ext Rear, or Off).

— **RF Sync Delay** - In measurements that detect the GSM “T0”, **RF Sync Delay** adjusts the “T0” point. This adjustment does not apply if the **Burst Sync** key is set to **None**, or if it is set to **Training Seq** in the Phase and Frequency Error measurement. The “T0” point is defined as the time point of the transition from bit 13 to bit 14 of the midamble training sequence for a given time slot.

— **Burst Search Threshold** - Sets the threshold level used in the search for EDGE or GSM bursts after data is acquired. This is a relative level based on the peak “on” power.

**Table 3-3**

<b>Trigger Default Settings</b>	
<b>RF Burst</b>	
Delay	0.000 s
Peak Level	-25.00 dB
Slope	Pos

Table 3-3

<b>Trigger Default Settings</b>	
<b>Video</b>	
Delay	0.000 s
Level	-6.00 dBm
Slope	Pos
<b>Ext Front</b>	
Delay	0.000 s
Level	2.00 V
Slope	Pos
<b>Ext Rear</b>	
Delay	0.000 s
Level	2.00 V
Slope	Pos
<b>Trig Holdoff</b>	0.000 s
<b>Auto Trig</b>	100.0 ms Off
<b>Frame Timer</b>	
Period	4.615383 ms
Offset	0.000 s
Reset Offset	Display
Sync Source	Off
<b>RF Sync Delay</b>	0.000 s
<b>Burst Search Threshold</b>	-30.00 dB

- **Demod Menu** (E4406A only)
  - **Burst Align** - Select the burst alignment between:
    - **GSM** - Uses the burst alignment as defined in the GSM specifications.
    - **1/2 Bit Offset** - Shifts the burst alignment by 1/2 bit. This selection applies to the Power vs. Time and the Phase and Frequency Error measurements.
  - **RF Carrier** - When carriers other than the signal of interest are present, especially if they are stronger, they can interfere with the measurement, making it difficult to sync and producing artificially high EVM results. When this condition exists, toggle **RF Carrier** from **Single** to select **Multi**. A band-limited filter 600KHz wide will help reduce the measurement interference. This selection is only available for EDGE EVM and GSM Phase and Frequency measurements.

**Table 3-4**

<b>Demod Default Settings</b>	
Demod Burst Align	GSM
RF Carrier	Single

## Input/Output Key Menu

Key Path: **Input/Output**

**Input** key menu:

---

**NOTE**

---

You can also access the **Input** key menu from the **Mode Setup, Input** front-panel key.

- **Input Port** - Allows you to access the menu to select one of the signal input ports as follows (including Baseband IQ Inputs, Option B7C, when installed in E4406A):
  - **RF** - Allows you to measure an RF signal supplied to the RF input port.
  - **I/Q** - (For E4406A, Requires E4406A Option B7C. See [“Using Option B7C Baseband I/Q Inputs” on page 127.](#)) Allows you to measure the I/Q input signals supplied to the **I** and **Q INPUT** ports.
  - **I only** - (Requires E4406A Option B7C. See [“Using Option B7C Baseband I/Q Inputs” on page 127.](#)) Allows you to measure the I input signal supplied to the **I INPUT** port.
  - **Q only** - (Requires E4406A Option B7C. See [“Using Option B7C Baseband I/Q Inputs” on page 127.](#)) Allows you to measure the I input signal supplied to the **Q INPUT** port.
  - **50 MHz Ref** - (For E4406A) Allows you to measure the **50 MHz Reference** signal to calibrate the instrument.
  - **Amptd Ref (f=50 MHz)** - (For PSA) Allows you to measure the 50 MHz reference signal to calibrate the instrument.
  - **IF Align** - Allows you to configure the IF alignment signal. The RF path is switched to bring in the same alignment signal that is automatically switched to perform many alignments.
  - **Baseband Align Signal** - (For E4406A) Selects an internal signal used for alignment of Option B7C baseband inputs.
- **I/Q Setup** - (For E4406A) Allows you to access the menu to select the input impedance for the baseband I/Q input signals, and to set the dc offset voltages for I/Q input signals. This key is grayed out unless **Input Port** is set to either **I/Q**, **I only**, or **Q only**.
  - **I Offset** - Allows you to set a dc offset voltage value for the I input signal. The range is 0.0000 to 2.5600 V in 0.0001 V.
  - **Q Offset** - Allows you to set a dc offset voltage value for the Q input signal. The range is 0.0000 to 2.5600 V in 0.0001 V.
  - **I/Q Input Z** - Allows you to access the menu to select one of the input impedances for baseband I/Q input signals as follows:

**50  $\Omega$  Unbalanced** - Allows you to set the input impedance to unbalanced 50  $\Omega$  for use with the I/Q input ports. This is the default setting.

**600  $\Omega$  Balanced** - Allows you to set the input impedance to balanced 600  $\Omega$  for use with the I/Q input ports and the I/Q input ports.

**1 M $\Omega$  Unbalanced** - Allows you to set the input impedance to 1 M $\Omega$  for use with the I/Q input ports.

**1 M $\Omega$  Balanced** - Allows you to set the input impedance to 1 M $\Omega$  for use with the I/Q input ports and the I/Q input ports.

— **I/Q Z Ref** - Allows you to enter a numeric value to set the reference impedance if **I/Q Input Z** is set to 1 M $\Omega$ , otherwise this key is grayed out.

- **RF Input Range** - Allows you to toggle the RF input range control between **Auto** and **Man** (manual). If **Auto** is chosen, the instrument automatically sets the attenuator based on the carrier power level, where it is tuned. Once you change the **Max Total Pwr** or **RF Input Atten** value with the RPG knob, for example, the **RF Input Range** key is automatically set to **Man**. If there are multiple carriers present, the total power might overdrive the front end. In this case you need to set the **RF Input Range** to **Man** and enter the expected maximum total power by activating the **Max Total Pwr** key. **Man** is also useful to hold the input attenuation constant for the best relative power accuracy. For single carriers it is generally recommended to set this to **Auto**.

---

**CAUTION**

If you manually change the RF Input range setting from **Auto** to **Man**, you may not have optimized the dynamic range for the current measurement, and you may not get the most accurate results. As a reminder, on selected measurements a message is displayed as follows: “Dynamic Range Not Optimum - set AUTO RF Input”. This message will not be displayed unless there is a measurement pending.

For PSA, when you use the internal preamplifier, Int Preamp, the selections using the **RF Input Range** key are not available, and the key is greyed-out.

For E4406A, if **Input Port** is set to **I/Q** this key is grayed out

- **Max Total Pwr** - Allows you to set the maximum total power level from the UUT (Unit Under Test). The range is  $-200.00$  to  $100.00$  dBm with 0.01 dB resolution. This is the expected maximum value of the mean carrier power referenced to the output of the UUT; it may include multiple carriers. The **Max Total Pwr** setting is coupled together with the **Input Atten** and **Ext Atten** settings. Once you change the **Max Total Pwr** value with the RPG knob, for example, the **Input Range** key is automatically set to **Man**.

For PSA, when you use the internal preamplifier, Int Preamp, the

selections using the **Max Total Pwr** key are not available, and the key is greyed-out.

For E4406A, when **Input Port** is set to **I/Q**, this key label changes to **I/Q Range**. It controls the maximum input voltages of the baseband I/Q input signals. The ranges are 130.0 mV, 250.0 mV, 500.0 mV and 1.0 V.

- **Input Atten** - Allows you to control the internal input attenuator setting. The range is 0 to 40 dB with 1 dB resolution. The **Input Atten** key reads out the actual hardware value that is used for the current measurement. If more than one input attenuator value is used in a single measurement, the value used at the carrier frequency will be displayed. The **Input Atten** setting is coupled to the **Max Total Pwr** setting. Once you change the **Input Atten** setting with the RPG knob, for example, the **Input Range** key is automatically set to **Man**.

For PSA, when you use the internal preamplifier, **Int Preamp**, the electronic attenuator selections using the **Input Atten** key are not available, and the key is greyed-out. Use the mechanical attenuator under **More 1 of 2, Attenuator**, below.

For E4406A, this attenuator is located in front of the first down converter, therefore it is cannot be used for the baseband I/Q input signals.

- **Ext RF Atten** - Allows you to access the following menu to enter the external attenuation values. Either of the **Ext RF Atten** settings is coupled together with the **RF Input Range** setting. However, pressing **Ext RF Atten** does not switch the **RF Input Range** key to **Man**. This will allow the instrument to display the measurement results referenced to the output of the UUT.
  - **MS** - Allows you to set an external attenuation value for MS tests. The range is -50.00 to +50.00 dB with 0.01 dB resolution.
  - **BTS** - Allows you to set an external attenuation value for BTS tests. The range is -50.00 to +50.00 dB with 0.01 dB resolution.
- **Int Preamp** - (For PSA, requires Option 1DS) Allows you to control the internal RF input preamplifier. The internal preamplifier provides +30 dB of gain and is useful for lower power measurements. The **Int Preamp** setting default is **Off**. RF power values displayed for these measurements are adjusted to compensate for the internal preamplifier gain, and indicate power levels at the input port. The preamplifier is only available for Modulation Accuracy (EVM and Peak Code Domain Error) measurements, QPSK EVM, and Code Domain measurements. If the **Int Preamp** is not available for a particular measurement, the key is greyed-out.

To avoid damaging the internal preamplifier, limit the total power applied to the RF input to  $\leq +25\text{dBm}$ .

When using the internal preamplifier, the electronic attenuator selections using the **Input Atten** key are not available, and the key is greyed-out. Use the mechanical attenuator under **More 1 of 2, Attenuator**, below.

- **Attenuator** - (For PSA, requires Option 1DS) When **Int Preamp** is set to **On**, this key allows you to control an internal mechanical input attenuator setting. The settings available are 0 dB, 10 dB, or 20 dB. The **Attenuator** key shows the actual hardware value that is used for the current measurement. The **Attenuator** setting is not coupled to the **Max Total Pwr** setting.

The **Attenuator** is only available for measurements which can use the **Int Preamp**: Modulation Accuracy (EVM and Peak Code Domain Error) measurements, QPSK EVM, and Code Domain measurements. If the **Int Preamp** is not available for a particular measurement, the key is greyed-out.

**NOTE**

The **Max Total Pwr** and **Input Atten** settings are coupled together, so changing the input **Max Total Pwr** setting by x dB changes the **Input Atten** setting by x dB. When you switch to a different measurement, the **Max Total Pwr** setting is kept constant, but the **Input Atten** may change if the two measurements have different mixer margins. Therefore, you can set the input attenuator manually, or you can set it indirectly by specifying the expected maximum power from the UUT.

<b>Input Default Settings</b>	
Input Port	RF
I/Q Setup <sup>a</sup> (E4406A only)	(disabled)
RF Input Range	Auto <sup>b</sup>
Max Total Pwr	-15.00 dBm <sup>c</sup>
Input Atten	0.00 dB <sup>c</sup>
Ext RF Atten: MS BTS	0.00 dB 0.00 dB
Int Preamp <sup>d</sup> (PSA only):	OFF

- This key is grayed out if **Input Port** is set to **RF**.
- Auto is not used for Spectrum (frequency domain) measurements.
- This may differ if the maximum input power is more than -15.00 dBm, or depending on the previous measurements.
- The preamplifier is only available for Modulation Accuracy (EVM and Peak Code Domain Error) measurements, QPSK EVM, and Code Domain measurements.

---

## Measurement Keys

### EDGE EVM (Error Vector Magnitude) Measurement Keys

---

**NOTE** Make sure the **EDGE EVM** measurement is selected under the **Measure** menu.

---

Key Path: **Meas Setup**

#### Meas Setup Key Menu

- **Avg Bursts On Off** - Allows you to select whether averages are made or not, and allows you to change the number of N averages that are made.
- **Avg Mode Exp Repeat** - Allows you to choose either exponential or repeat averaging. This selection only effects the averaging after the number of N averages is reached (set using the **Averages**, **Avg Bursts**, or **Avg Number** key).
  - **Normal averaging:** Normal (linear) averaging is always used until the specified number of N averages is reached. When **Measure** is set at **Single**, data acquisitions are stopped when the number of averages is reached - thus **Avg Mode** has no effect on single measurements.
  - **Exponential averaging:** When **Measure** is set at **Cont**, data acquisitions will continue indefinitely. After N averages, exponential averaging is used with a weighting factor of N (the displayed average count stops at N). Exponential averaging weights new data more than old data, which allows tracking of slow-changing signals. The weighting factor N is set using the **Averages**, **Avg Bursts**, or **Avg Number** key.
  - **Repeat averaging:** When **Measure** is set at **Cont**, data acquisitions will continue indefinitely. After N averages is reached, all previous result data is cleared and the average count is set back to 1. This is equivalent to being in **Measure Single** and pressing the **Restart** key when the Single measurement finishes.
- **Trig Source Key Menu**

Changing the selection in the **Trig Source** menu alters the trigger source for the selected measurement only. Not all of the selections are available for all measurements. Note that the **RF Burst (Wideband)**, **Video (IF Envlp)**, **Ext Front**, and **Ext Rear** menu keys found in the **Trigger** menu enable you to change settings to modify the delay, level, and slope for each of these trigger sources. Choose one of



the following sources:

- **Free Run (Immediate)** - The trigger occurs at the time the data is requested, completely asynchronous to the RF or IF signal.
- **RF Burst (Wideband)** - An internal wideband RF burst trigger that has an automatic level control for burst signals. It triggers on a level that is relative to the peak of the signal passed by the RF. If the data sent is all 0 bits, this trigger will give erratic or falsely high EVM results.
- **Video (IF Envelope)** - An internal IF envelope trigger. It triggers on an absolute threshold level of the signal passed by the IF.
- **Ext Front** - Activates the front panel external trigger input (**EXT TRIGGER INPUT**). The external trigger must be a signal between -5 and +5 volts.
- **Ext Rear** - Activates the rear panel external trigger input (**TRIGGER IN**). The external trigger must be a signal between -5 and +5 volts.
- **Frame** - Uses the internal frame clock to generate a trigger signal. The clock parameters are controlled under the **Mode Setup** key or the measurement firmware, but not both. See the specific measurement for details.
- **Line** - activates an internal line trigger. Sweep triggers occur at intervals synchronized to the line frequency.

---

**NOTE**

Rear panel **TRIGGER 1 OUT** and **TRIGGER 2 OUT** connectors are coupled to the selected trigger source. These trigger outputs are always on the rising edge with a pulse width of at least 1  $\mu$ s.

---

- **Burst Sync**

Pressing the **Burst Sync** key allows you to choose the source used to synchronize the measurement to the “T0” point of the GSM or EDGE burst. The “T0” point is defined as the time point of the transition from bit 13 to bit 14 of the midamble training sequence for a given time slot. The

**Burst Search Threshold** setting (in the **Mode Setup** keys under **Trigger**) applies to both **Training Seq** and **RF Amptd**. Pressing the **Burst Sync** key will bring up a menu with some or all of the following choices:

- **Training Seq** - Synchronizes the measurement to the timing of the demodulated training sequence in the GSM burst. This is the most precise method, but requires a GMSK or EDGE burst with a valid TSC (Training Sequence Code). The “T0” point is determined by demodulation of the burst and successful identification of the TSC. “T0” is then found to within 1/10 bit.
- **RF Amptd** - Synchronizes the measurement to the burst transition

Key Reference  
Measurement Keys

of the measured RF carrier. “T0” is set to the 50% point between the start and end of the burst.

— **None** - Use the start of the time record as the start of the useful part. “T0” is set to the middle of the useful part.

- **Limits Key Menu**

Changing the selection in the **Limits** menu allows you to select limits from a set of standard settings, or allows you to set your own limits. The limits vary depending on whether the **Radio** is **MS** or **BS**:

— **Test Condition** - Select either **Normal** or **Extreme** according to your test temperature conditions.

— **RMS EVM** - Allows you to set a limit for RMS EVM in percent.

— **Peak EVM** - Allows you to set a limit for Peak EVM in percent.

— **95 %tile EVM** - Allows you to set a limit for 95%tile EVM in percent.

— **I/Q Origin Offset** - Allows you to set a limit for I/Q Origin Offset in dBc.

— **Freq Error** - Allows you to set a limit for Freq Error in ppm.

- **Extreme Limits**

Changes the EVM test to the “extreme conditions” limits, as defined in the GSM 3GPP standards. See “**Error Vector Magnitude Measurement Defaults**” on page 155 for details.

- **Droop Comp**

Turns on an algorithm to compensate for power droop in the EVM measurement. The power correction for droop is shown in dB/symbol across the 142 symbol burst. Droop compensation allows the measurement to minimize the contribution of amplifier power variations to the EVM results.

- **Freq Err Tol Range**

This key toggles between **Wide** and **Normal** settings for Frequency Error tolerance. To accurately demodulate more complex signals which require more stringent tolerance for frequency error, like multiple channels on the same carrier, select **Normal**. You can select **Wide** for use with signals that are simpler with greater frequency error tolerance.

The next table shows the factory default settings for error vector magnitude measurements.

**Table 3-5 Error Vector Magnitude Measurement Defaults**

<b>Measurement Parameter</b>	<b>Factory Default Condition</b>
Avg Number	10, On
Avg Mode	Exponential
Trigger Source	RF Burst (Wideband)
Burst Sync	Training Seq (TSC)
Trace/View	I/Q Measured Polar Vector
Test Condition	Normal
Limits (BS): RMS EVM	7%, normal 8%, extreme
Limits (MS): RMS EVM	9%, normal 10%, extreme
Limits (BS): Peak EVM	22%, normal 22%, extreme
Limits (MS): Peak EVM	30%, normal 30%, extreme
Limits (BS): 95th percentile EVM	11%, normal 11%, extreme
Limits (MS): 95th percentile EVM	15%, normal 15%, extreme
Limits (BS): I/Q Origin Offset	-35 dBc, normal -35 dBc, extreme
Limits (MS): I/Q Origin Offset	-35 dBc, normal -35 dBc, extreme
Frequency Error (Base Normal Micro)	0.05ppm, normal 0.05ppm, extreme
Frequency Error (Base Pico)	0.1 ppm, normal 0.1 ppm, extreme
Frequency Error (Mobile)	0.1 ppm, normal 0.1 ppm, extreme

## Trace/View Key Menu

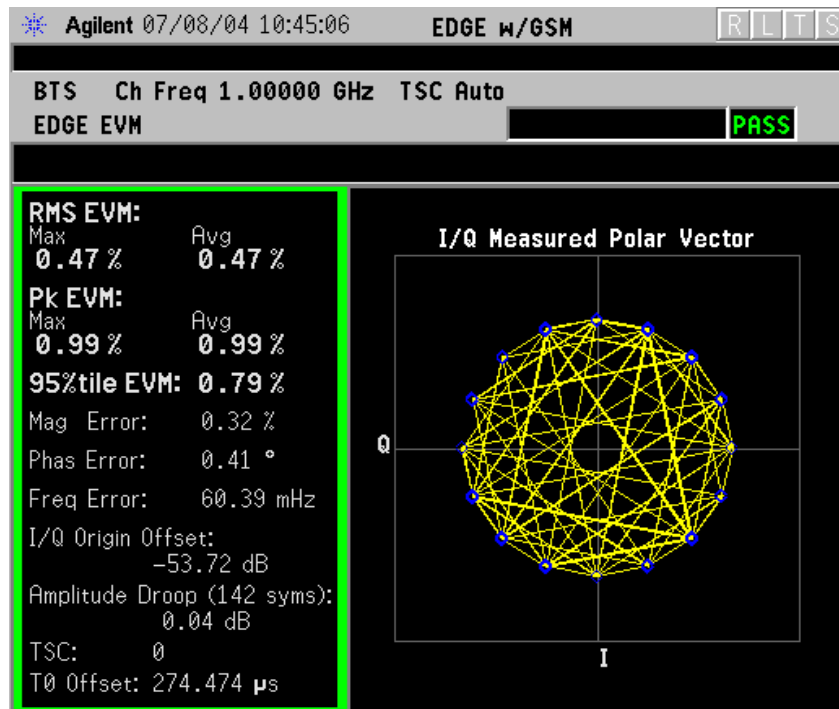
Key Path: **Trace/View**

The **Trace/View** key accesses the menu which allows you to select the desired measurement view from the following selections:

- **Polar Vector** - The measured summary data is shown in the left window and the dynamic vector trajectory of the I/Q demodulated signal is shown as a vector display in the right window. The polar vector view presents a constantly changing display.

Measurement results displayed include: RMS EVM, Peak EVM, 95%tile EVM, Mag Error, Phase Error, Frequency Error, I/Q Origin Offset, Amplitude Droop, Training Sequence number (TSC), and T0 Offset.

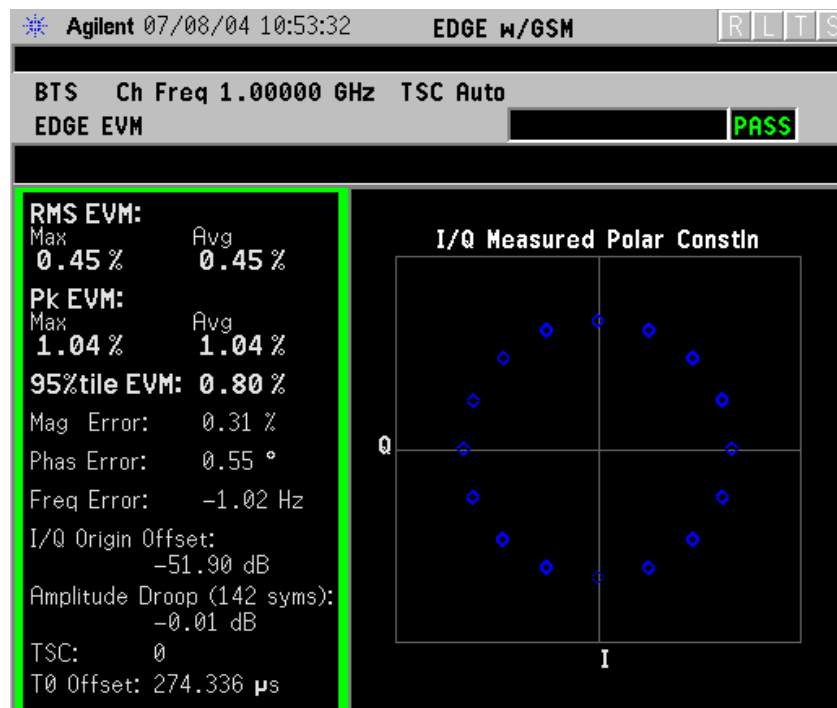
**Figure 3-3** EDGE EVM Result - Polar Vector View



- **Polar Constln** - The measured summary data is shown in the left window and the dynamic constellation of the I/Q demodulated signal is shown as a polar display in the right window. See [Figure 3-4 on page 157](#).

Measurement results displayed include: RMS EVM, Peak EVM, 95%tile EVM, Mag Error, Phase Error, Frequency Error, I/Q Origin Offset, Amplitude Droop, Training Sequence number (TSC), and T0 Offset.

**Figure 3-4** EDGE EVM Result- Polar Constln

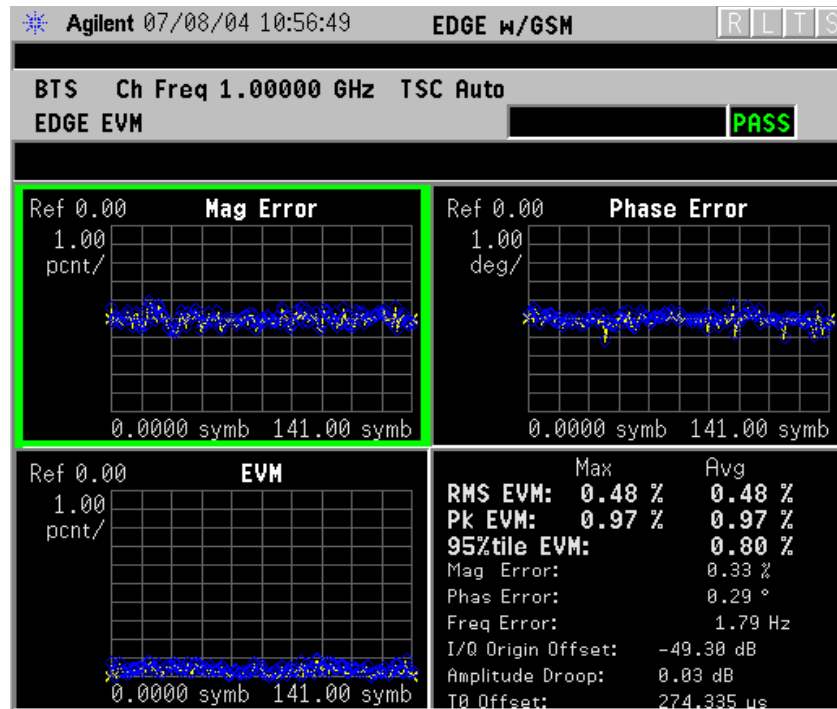


Key Reference  
Measurement Keys

- **I/Q Error (Quad-View)** - Four display windows show EVM, Mag Error and Phase Error graphs, and the EVM summary data text.

Measurement results displayed include: RMS EVM, Peak EVM, 95%tile EVM, Mag Error, Phase Error, Frequency Error, I/Q Origin Offset, Amplitude Droop, Training Sequence number (TSC), and T0 Offset.

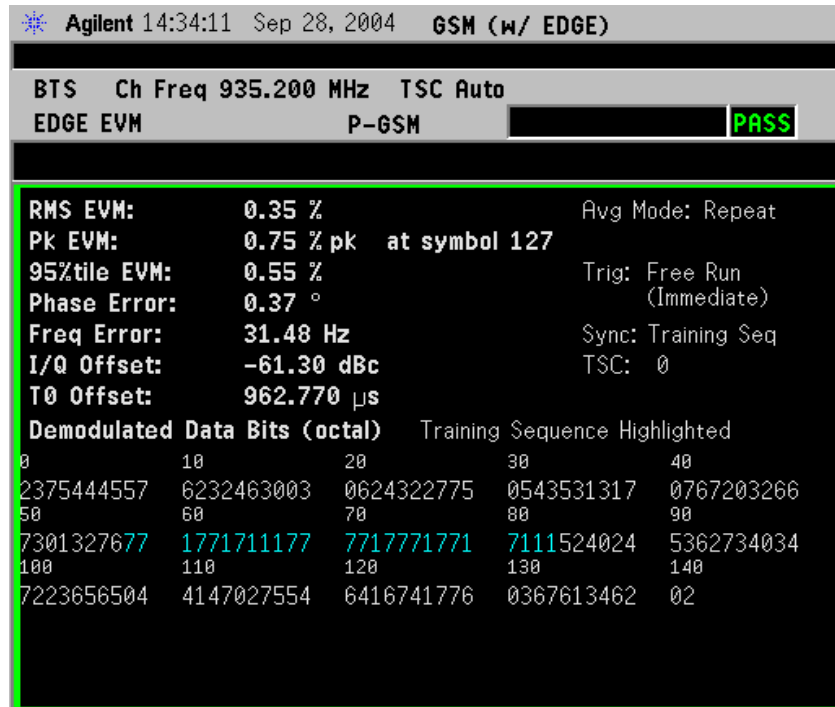
**Figure 3-5** EDGE EVM Result - I/Q Error (Quad View)



- **Data Bits** - See [Figure 3-6](#). Provides a view of the numeric results and data bits (in octal) with the sync word (TSC) highlighted.

Measurement results displayed include: RMS EVM, Peak EVM, 95%tile EVM, Mag Error, Phase Error, Frequency Error, I/Q Origin Offset, Amplitude Droop, Training Sequence number (TSC), and T0 Offset.

**Figure 3-6 EDGE EVM Result - Data Bits View**



### Display Key Menu

Key Path: **Display** -

The **Display** key accesses the menu to allow the following selections for changing the graph displays:

- **Symbol Dots** - Allows you to toggle the symbol dots between **On** and **Off**. The default setting is **On**.

## Span X Scale Key Menu

Key Path: **Span X Scale**

---

### NOTE

When either **EVM**, **Phase Error** or **Mag Error** window is active in the **I/Q Error (Quad-View)** display, the **Span X Scale** key accesses the menu to allow the following selections:

---

- **Scale/Div** - Allows you to define the horizontal scale by changing the symbol value per division. The range is 1 to 500K symbols per division. The default setting is 14.1 symbols per division for BTS and MS device types.
- **Ref Value** - Allows you to set the symbol reference value ranging from 0 to 500K symbols. The default setting is 0.
- **Ref Position** - Allows you to set the reference position to either **Left**, **Ctr** (center) or **Right**. The default setting is **Left**.
- **Scale Coupling** - Allows you to toggle the scale coupling function between **On** and **Off**. The default setting is **On**. This function automatically determines the scale per division and reference value by the magnitude of the measurement results.

## AMPLITUDE Y Scale Key Menu

Key Path: **AMPLITUDE Y Scale**

---

### NOTE

When **EVM**, **Phase Error**, or **Mag Error** windows are active in the **I/Q Error (Quad-View)** display, the **Amplitude Y Scale** key accesses a menu which allows the following selections:

---

- **Scale/Div** - Allows you to define the vertical scale by changing the value per division, with units, ranges, and default values depending on which display window is active.
  - **Mag Error Window** - Units are in Percent, range is from 0.1% to 50.0%, the default is 1.00%.
  - **Phase Error Window** - Units are in degrees, range is from 0.01 degrees to 3000 degrees, the default is 1.00 degrees.
  - **EVM Window** - Units are in Percent, range is from 0.1% to 50.0%, the default is 1.00%

Since the **Scale Coupling** default is set to **On**, the value displayed in this condition is automatically determined by the measurement results.

- **Ref Value** - Allows you to set the reference value, with units, ranges, and default values depending on which display window is active.
  - **Mag Error Window** - Units are in Percent, range is from -500.0%



to 500.0%, the default is 0.00%.

- Phase Error Window - Units are in degrees, range is from -36000.0 degrees to 36000.0 degrees, the default is 0.00 degrees.
- EVM Window - Units are in Percent, range is from -500.0% to 500.0%, the default is 0.00%.
- **Ref Position** - Allows you to set the reference position to **Top**, **Ctr** (center) or **Bot** (bottom).
  - Mag Error Window - The default is Ctr.
  - Phase Error Window - The default is Ctr.
  - EVM Window - The default is Top.
- **Scale Coupling** - Allows you to toggle the scale coupling function between **On** and **Off**. The default setting is **On**. This function automatically determines the scale per division and reference value by the magnitude of the measurement results.

## EDGE Output RF Spectrum Measurement Keys

---

### NOTE

This measurement is designed for EDGE. For the GSM Output RF Spectrum measurement see [“GMSK Output RF Spectrum Measurement Keys”](#) on page 184.

Make sure the **EDGE ORFS** measurement is selected under the **Measure** menu.

---

### Meas Setup Key Menu

Key Path: **Meas Setup**

- **Avg Bursts On Off** - Allows you to select whether averages are made or not, and allows you to change the number of N averages that are made.
- **Meas Type** - accesses a menu to choose the measurement that is optimized for the type of spectral distortion being investigated.
  - **Mod & Switch** - will perform both Modulation and Switching measurements, which measures the spectrum due to the 0.3 GMSK modulation and noise, and also measures Switching (transient) spectrum.
  - **Modulation** - measures the spectrum optimized for distortion due to the 0.3 GMSK modulation and noise.
  - **Switching** - measures the spectrum optimized for distortion due to switching transients (burst ramping).
  - **Full Frame Modulation (FAST)**- improves measurement speed by acquiring a full frame of data prior to performing the FFT calculation. This feature can only be used when all slots in the transmitted frame are active. Use of an external trigger can enhance measurement speed when this feature is used. When **Full Frame Modulation (FAST)** is selected the current measurement defaults to the multi-offset measurement method; therefore the **Meas Method** key is grayed out and the **Single Offset** feature is not available.
- **Meas Method** - accesses a menu to choose the measurement mode.
  - **Multi-Offset** - automatically makes measurements at all offset frequencies in the selected list (**Standard**, **Short**, or **Custom**). (See table below.) Press the **Multi-Offset Freq List** key to select a list of offsets to measure.

Offset measurement results are displayed as tabular data, and may be viewed as either absolute powers in the Modulation Power and Switching Power views, or as powers relative to the margins and limit settings in the Modulation Margin and Limit and Switching Margin and Limit views. See [“Trace/View Key Menu”](#)

on page 169, and “EDGE ORFS Measurement Results” on page 63.

- **Single Offset (Examine)** - makes a measurement at a single offset frequency as set by the **Offset Freq** softkey.

Single offset measurement results are displayed in a time domain plot, with the measurement effective RBW shown as a gate by white vertical lines. See “EDGE ORFS Measurement Results” on page 63.

- **Swept** - makes a measurement using time-gated spectrum analysis to sweep the analyzer with the gate turned on for the desired portion of the burst only, as set by the **Modulation Ofs (offsets) & Limits** menu. The limits mask is applied to the spectrum plot, and the **Worst Frequency** parameters are displayed. This selection is only available if **Meas Type** is set to **Modulation**. See “EDGE ORFS Measurement Results” on page 63.

- **Multi-Offsets Freq List** - accesses a menu to choose a predefined offset frequency list. Select a **Standard**, **Short**, or **Custom** list as shown in the table below. This selection is only available if **Meas Method** is set to **Multi-Offset**.

List	Modulation Offsets (kHz)	Switching Transients Offsets (kHz)
Standard	100, 200, 250, 400, 600, 800, 1000, 1200, 1400, 1600, 1800, 3000, 6000	400, 600, 1200, 1800
Short	200, 250, 400, 600, 1200, 1800	400, 600, 1200, 1800
Custom	User-defined list that specifies: Offset Freq, RES BW, Limit Offsets  Initialized to be the same as the standard list	User-defined list that specifies: Offset Freq, RES BW, Limit Offsets  Initialized to be the same as the standard list

- **Modulation Ofs & Limits** - accesses a menu to set offset frequencies and limits for Modulation measurements. Settings made in this menu do not modify the GSM/EDGE standard settings. This selection is only available if **Multi-Offset Freq List** is set to **Custom**.
  - **Offset** - Select an offset by letter designation from **A** to **O**
  - **Offset Freq** - Turn a custom frequency offset **ON** or **OFF** and specify the offset frequency.
  - **Res BW** - Set the custom resolution bandwidth of the measurement. Narrower **Res BW** settings will slow the

Key Reference  
Measurement Keys

measurement speed, but will give improved results for lower power signals.

- **Rel Limit Level Offset** - Set a custom level limit offset from the standard-defined relative limit in dB. The range is +/- 50 dB.
- **Abs Limit Level Offset** - Set a custom level limit offset from the standard-defined absolute limit in dB. The range is +/- 50 dB.
- **Apply Level Offset** - Toggle this key to select which Limit Level Offsets are applied from the selections listed below:
  - Rel - Custom setting for **Rel Limit Level Offset** is applied to the standard-defined relative limit.
  - Abs - Custom setting for **Abs Limit Level Offset** is applied to the standard-defined absolute limit.
  - Both - Custom settings for **Rel Limit Level Offset** and **Abs Limit Level Offset** are applied.
- **Switching Ofs & Limits Multi-Ofs Freq List** accesses a menu to set offset frequencies and limits for Custom Switching measurements. Settings made in this menu do not modify the GSM/EDGE standard settings. This selection is only available if **Multi-Offset Freq List** is set to **Custom..**
  - **Offset** - Select an offset by letter designation from **A** to **O**
  - **Offset Freq** - Turn a custom frequency offset **ON** or **OFF** and specify the offset frequency.
  - **Res BW** - Set the custom resolution bandwidth of the measurement. The default is 30 kHz. Narrower **Res BW** settings will slow the measurement speed, but will give improved results for lower power signals.
  - **Rel Limit Level Offset** - Set a custom level offset from the standard-defined relative limit in dB. The range is +/- 50 dB.
  - **Abs Limit Level Offset** - Set a custom level limit offset from the standard-defined absolute limit in dB. The range is +/- 50 dB.
  - **Apply Level Offset** - Toggle this key to select which Limit Level Offsets are applied from the selections listed below:
    - Rel - Custom setting for **Rel Limit Level Offset** is applied to the standard-defined relative limit.
    - Abs - Custom settings for **Abs Limit Level Offset** is applied to the standard-defined absolute limit.
    - Both - Custom settings for **Rel Limit Level Offset** and **Abs Limit Level Offset** are applied.
- **Offset Freq** - Only available when **Measure** is set to **Single Offset (Examine)**. Offset frequencies can be entered using the RPG knob or

the Data Entry keys.

- **Trig Source** - in this measurement, trigger source and burst sync are linked. Refer to the explanation under **Burst Sync**.
- **Burst Sync** - Synchronization is different on ORFS compared to other measurements. Since offsets may be very low power and acquired using very narrow filters, the burst edges are not well defined and there may be insufficient information to perform demodulation. Therefore all synchronization is performed on the carrier. The timing reference (“T0”) is then re-used on the offsets. Since “T0” on the carrier is determined with respect to the trigger point, the trigger point on the offsets is very important. Once “T0” is determined, the 50% and 90% points can be found.

Therefore, the trigger must be synchronous with respect to a rising edge of a burst. The RF Burst trigger will do this if the offset is within about 7 MHz of the carrier. Remember that since the RF Burst trigger is wideband, the carrier will still cause the signal to trigger. As long as the trigger threshold remains constant, the trigger with respect to the burst will remain constant. Since the Frame Trigger uses an internal frame timer (clock), its period is set so that it occurs synchronously with respect to the transmitting frame. If an external trigger is used, it is important that it is synchronous with the burst.

Because of these requirements, you may select the trigger source, but the measurement selects the required burst sync type based on your trigger source selection.

Trigger Source	Measurement Defined Burst Sync
Free Run	None
RF Burst	RF Amplitude
Ext Front	External
Ext Rear	External
Frame	Training Sequence

**NOTE**

Video is not allowed as a trigger source because when the instrument is tuned to frequencies offset from the carrier, the video trigger threshold will not be reached due to low power levels at the offset.

- **Fast Avg** - Fast averaging is a technique developed by Agilent. The GSM standard specifies 50% to 90% portion of the burst, excluding the midamble, be measured. Since most offsets are measured in a 30 kHz filter, there is a lot of variation from burst to burst, hence the averaging.

Key Reference  
Measurement Keys

The fast average method makes use of the 10% to 90% portion of the burst, excluding the midamble. The 10% to 50% portion of the burst has statistically the same average power as the 50% to 90%. Therefore, measuring both portions from one burst is statistically the same as measuring 50% to 90% from two bursts. Now, two averages are completed with one burst. When Fast averaging is turned on, this will double the speed of the measurement.

This method is only applicable on the modulation portion of the test, and only when averaging is enabled. The method is not available when Modulation and Switching are done at the same time.

- **Advanced** - accesses a menu with the following keys:

---

**NOTE**

Parameters under the Advanced key seldom need to be changed. Changes from default values may result in invalid measurement data.

— **Mod Avg** - choose between:

- Pwr Avg (RMS)**
- Log-Pwr Avg (Video)**

— **Switching Avg** - information only. When averaging is off, the peak value of the burst is retained. When averaging is on, the maximum of the peak values is retained.

— **Modulation Meas BWs** - accesses a menu with the following selections:

---

**NOTE**

Changing these RBW settings will modify standard-defined values. Changes to these settings will affect all EDGE ORFS measurements, except for Custom Multi-Offset measurements (where custom RBW setting in Modulation/Switching Ofs & Limits menu is used) and Modulation Swept measurements (where RBW is set to 30 kHz).

- Carrier RBW**
- <1800 kHz Offset RBW**
- >=1800 kHz Offset RBW**
- VBW/RBW Ratio** - information only. Bandwidth ratio is fixed at 1.

— **Switching Meas BWs** - accesses a menu with the following selections:

- Carrier RBW**
- <1800 kHz Offset RBW**
- >=1800 kHz Offset RBW**
- VBW/RBW Ratio** - information only. Switching ratio is fixed at 3.

- **Direct Time Break Freq** - Selects the transition frequency (the first offset frequency) where the Direct Time Domain method is used instead of the FFT method. The Direct Time Domain offers a high dynamic range and is faster for making measurements at a few offset frequencies. The FFT method has a moderate dynamic range (generally sufficient when the RBW = 30 kHz). It is much faster for measuring at many offset frequencies
- **Fast Peak Det** - Improves measurement speed by utilizing the running peak measurement capability of the DSP hardware without calculating averages separately. The previous method may be used for backwards compatibility by turning **Fast Peak Det** off.

Table 3-6

**Output RF Spectrum Measurement Defaults**

Measurement Parameter	Factory Default Condition
Avg Bursts	20 On
Avg Mode	Repeat
Meas Method	Multi-Offset
Meas Type	Modulation
Ofs Freq List	Short
Offset Freq (when single offset is selected)	250.000 kHz
Trig Source	RF Burst
Burst Sync (information only)	RF Amptd
Fast Avg	On
Mod Method	Discrete
<b>Advanced</b>	
Mod Avg	Log-Pwr Avg (Video)
Switching Avg (information only)	Max of Peak
Direct Time Break Freq	600.000 kHz
Fast Peak Det	On
Modulation Meas BWs	
Carrier RBW	30.000 kHz
<1800 kHz Offset RBW	30.000 kHz
≥1800 kHz Offset RBW	100.000 kHz
VBW/RBW Ratio (information only)	1
Switching Meas BWs	
Carrier RBW	300.000 kHz
<1800 kHz Offset RBW	30.000 kHz
≥1800 kHz Offset RBW	30.000 kHz
VBW/RBW Ratio (information only)	3

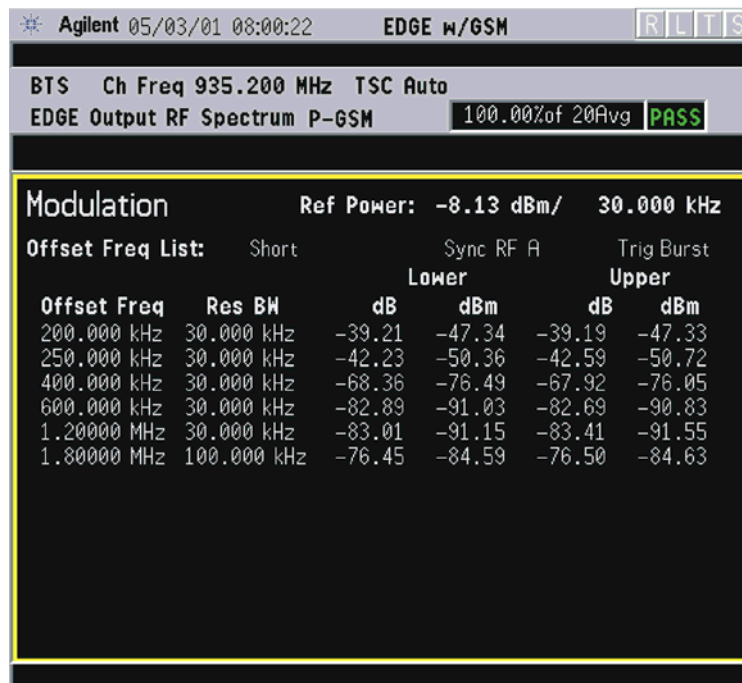


### Trace/View Key Menu

Key Path: Trace/View

- **Modulation Power** - When **Meas Method** is set to **Multi-Offset**, and **Meas Type** is set to **Modulation**, or **Mod and Switch**, measurement results may be viewed as absolute powers in tabular form. The data will display offsets from any of the the **Multi-Offset Freq List** settings: **Standard**, **Short**, and **Custom**.

**Figure 3-7** EDGE ORFS Result - Example (Short List)  
**Modulation Power View**



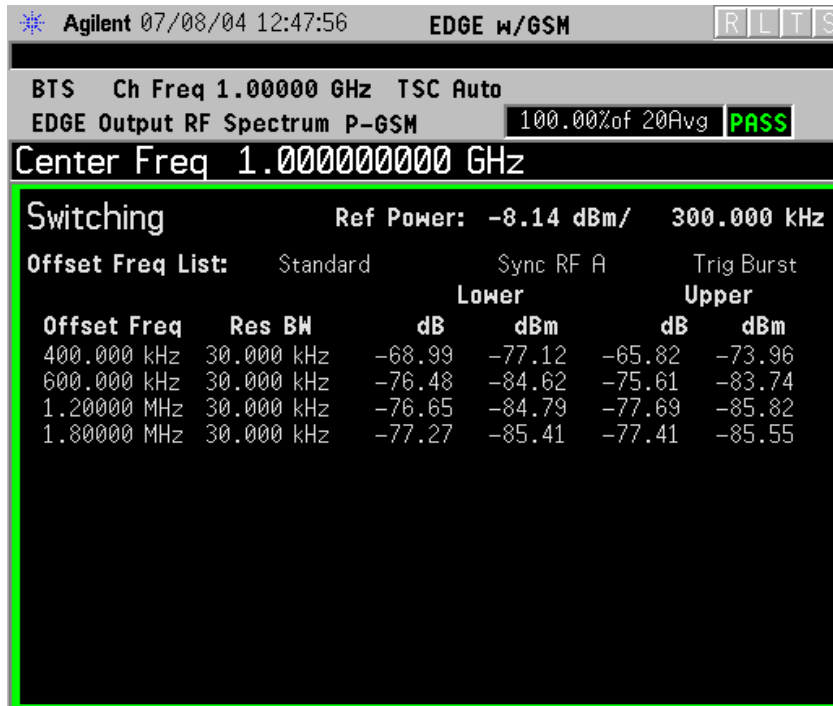
- **Modulation Margins & Limits-** When **Meas Method** is set to **Multi-Offset**, and **Meas Type** is set to **Modulation**, or **Mod and Switch**, measurement results may be viewed as relative powers in tabular form. The data will display offsets from any of the the **Multi-Offset Freq List** settings: **Standard**, **Short**, and **Custom**, and shows the limit values selected by frequency, with the corresponding measurement result deltas.

**Figure 3-8** **EDGE ORFS Result - Example (Short List)**  
**Modulation Margin & Limits View**



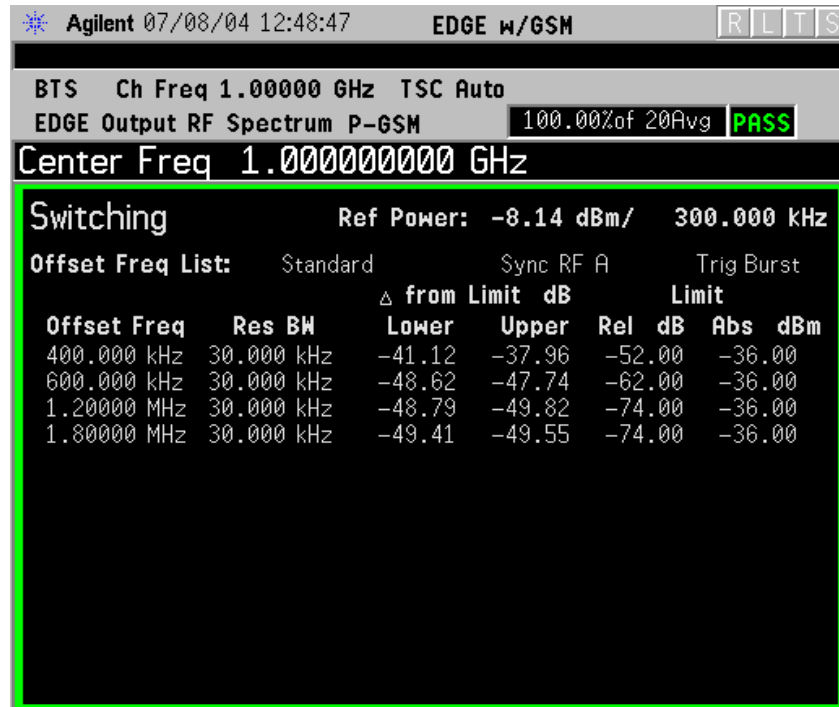
- **Switching Power** - When **Meas Method** is set to **Multi-Offset**, and **Meas Type** is set to **Switching**, or **Mod and Switch**, measurement results may be viewed as absolute powers in tabular form. The data will display offsets from any of the the **Multi-Offset Freq List** settings: **Standard**, **Short**, and **Custom**.

**Figure 3-9** EDGE ORFS Result - Example (Short List)  
**Switching Power View**



- **Switching Margins & Limits**- When **Meas Method** is set to **Multi-Offset**, and **Meas Type** is set to **Switching** or **Mod and Switch**, measurement results may be viewed as relative powers in tabular form. The data will display offsets from any of the the **Multi-Offset Freq List** settings: **Standard**, **Short**, and **Custom**, and shows the limit values selected by frequency, with the corresponding measurement result deltas.

**Figure 3-10** EDGE ORFS Result - Example (Short List)  
Switching Margin & Limits View



**NOTE**

If the Single Offset measurement has been chosen, the **Trace/View** softkey is unavailable (grayed out) as both modulation and switching results are always displayed.

## EDGE Power vs. Time Measurement Keys

---

**NOTE**

---

Make sure the **EDGE Pwr vs Time** measurement is selected under the **Measure** menu.

### Meas Setup Key Menu

Key Path: **Meas Setup**

- **Avg Bursts On Off** - Allows you to select whether averages are made or not, and allows you to change the number of N averages that are made.
- **Avg Mode Exp Repeat** - Allows you to choose either exponential or repeat averaging. This selection only effects the averaging after the number of N averages is reached (set using the **Averages**, **Avg Bursts**, or **Avg Number** key).
  - **Normal averaging:** Normal (linear) averaging is always used until the specified number of N averages is reached. When **Measure** is set at **Single**, data acquisitions are stopped when the number of averages is reached - thus **Avg Mode** has no effect on single measurements.
  - **Exponential averaging:** When **Measure** is set at **Cont**, data acquisitions will continue indefinitely. After N averages, exponential averaging is used with a weighting factor of N (the displayed average count stops at N). Exponential averaging weights new data more than old data, which allows tracking of slow-changing signals. The weighting factor N is set using the **Averages**, **Avg Bursts**, or **Avg Number** key.
  - **Repeat averaging:** When **Measure** is set at **Cont**, data acquisitions will continue indefinitely. After N averages is reached, all previous result data is cleared and the average count is set back to 1. This is equivalent to being in **Measure Single** and pressing the **Restart** key when the Single measurement finishes.
- **Avg Type** - Select the averaging type from the following selections: (Not all of the selections are available for all measurements)
  - **Pwr Avg (RMS)** - True power averaging that is equivalent to taking the RMS value of the voltage. It is the most accurate type of averaging.
  - **Log-Pwr Avg (Video)** - Simulates the traditional spectrum analyzer type of averaging by averaging the log of the power.
  - **Mean** - Averages the mean values.
  - **Voltage Avg** - Averages the voltage values.
  - **Maximum** - Keeps track of the maximum values.

Key Reference  
Measurement Keys

- **Minimum** - Keeps track of the minimum values.
- **Max & Min** - Keeps track of the maximum and minimum values.
- **Meas Time** - allows you to measure more than one timeslot. Enter a value in integer increments of “slots” with a range of 1 to 8. The actual measure time in  $\mu\text{s}$  is set somewhat longer than the specified number of slots in order to view the complete burst.
- **Trig Source Key Menu**

Changing the selection in the **Trig Source** menu alters the trigger source for the selected measurement only. Not all of the selections are available for all measurements. Note that the **RF Burst (Wideband)**, **Video (IF Envlp)**, **Ext Front**, and **Ext Rear** menu keys found in the **Trigger** menu enable you to change settings to modify the delay, level, and slope for each of these trigger sources. Choose one of the following sources:

- **Free Run (Immediate)** - The trigger occurs at the time the data is requested, completely asynchronous to the RF or IF signal.
- **RF Burst (Wideband)** - An internal wideband RF burst trigger that has an automatic level control for burst signals. It triggers on a level that is relative to the peak of the signal passed by the RF. If the data sent is all 0 bits, this trigger will give erratic or falsely high EVM results.
- **Video (IF Envlp)** - An internal IF envelope trigger. It triggers on an absolute threshold level of the signal passed by the IF.
- **Ext Front** - Activates the front panel external trigger input (**EXT TRIGGER INPUT**). The external trigger must be a signal between  $-5$  and  $+5$  volts.
- **Ext Rear** - Activates the rear panel external trigger input (**TRIGGER IN**). The external trigger must be a signal between  $-5$  and  $+5$  volts.
- **Frame** - Uses the internal frame clock to generate a trigger signal. The clock parameters are controlled under the **Mode Setup** key or the measurement firmware, but not both. See the specific measurement for details.
- **Line** - activates an internal line trigger. Sweep triggers occur at intervals synchronized to the line frequency.

Rear panel **TRIGGER 1 OUT** and **TRIGGER 2 OUT** connectors are coupled to the selected trigger source. These trigger outputs are always on the rising edge with a pulse width of at least  $1 \mu\text{s}$ .

- **Burst Sync**

Pressing the **Burst Sync** key allows you to choose the source used to synchronize the measurement to the “T0” point of the GSM or EDGE

burst. The “T0” point is defined as the time point of the transition from bit 13 to bit 14 of the midamble training sequence for a given time slot. The **Burst Search Threshold** setting (in the **Mode Setup** keys under **Trigger**) applies to both **Training Seq** and **RF Amptd**. Pressing the **Burst Sync** key will bring up a menu with some or all of the following choices:

- **Training Seq** - Synchronizes the measurement to the timing of the demodulated training sequence in the GSM burst. This is the most precise method, but requires a GMSK or EDGE burst with a valid TSC (Training Sequence Code). The “T0” point is determined by demodulation of the burst and successful identification of the TSC. “T0” is then found to within 1/10 bit.
- **RF Amptd** - Synchronizes the measurement to the burst transition of the measured RF carrier. “T0” is set to the 50% point between the start and end of the burst.
- **None** - The start of the time record is the start of the measured data. Set **Trigger Delay** as needed to capture the data to be measured.
- **Pwr Cntrl Lvl** - used to indicate the output power of the transmitter; in MS testing transmitter output power variations will affect the mask (in BTS testing the mask is not affected). The appropriate power level for measuring the device under test will correspond with the transmitter power control level setting. Enter a value between 0 and 40.

---

**NOTE**

Parameters that are under the **Advanced** key seldom need to be changed. Any changes from the default values may result in invalid measurement data.

---

- **Advanced** - accesses a menu to change the following parameters:
  - **RBW Filter** - chooses the type of filter, either **Gaussian** or **Flat** (Flatop). Gaussian is the best choice when looking at the overall burst or the rising and falling edges, as it has excellent pulse response. If you want to precisely examine just the useful part of the burst, choose **Flat**.
  - **Res BW** - sets the resolution bandwidth.
  - **Timeslot Length** - Timeslot configurations can appear in two forms. When making Multi-slot measurements, select a type of timeslot length configuration from the following list:
    - **All 156.25 symb** - a uniform limit mask of 156.25 symbols in length is applied to all slots.
    - **157/156 symb** - a limit mask of 157 symbols in length is applied to slots 0 and 4, while a limit mask of 156 symbols in length is applied to slots 1, 2, 3, 5, 6 and 7.

Table 3-7

**EDGE Power vs. Time Measurement Defaults**

Measurement Parameter	Factory Default Condition
Avg Bursts	10 Off
Avg Mode	Exp
Avg Type	Pwr Avg (RMS)
Meas Time	1 Slot
Timeslot	0
Trig Source	RF Burst (Wideband)
Burst Sync	Training Seq
<b>Advanced</b>	
RBW Filter	Gaussian
Res BW	500.000 kHz

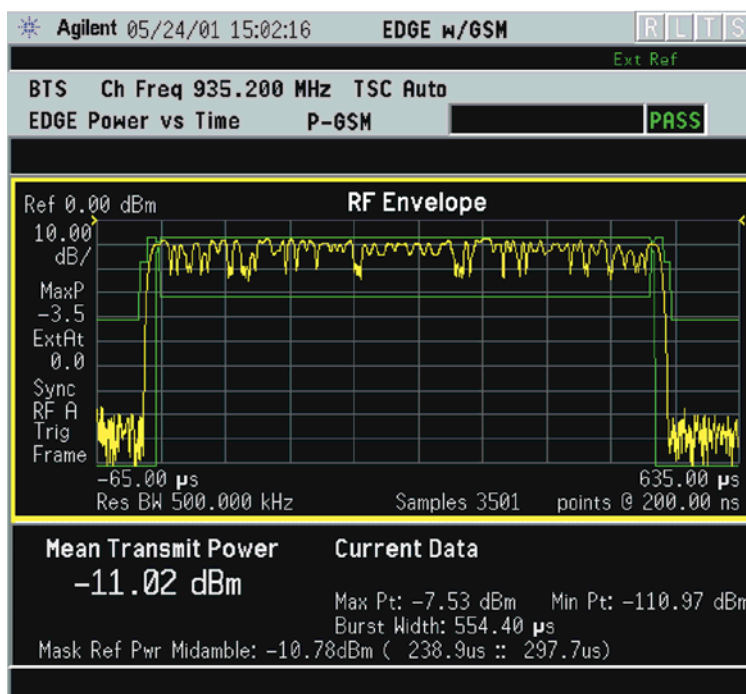


## Trace/View Key Menu

Key Path: **Trace/View**

- **Burst** - views the entire burst of interest as determined by the current trigger source, burst sync, training sequence, and timeslot settings. To view a different burst of interest you must set these parameters for the selected timeslot. To view multiple slots use the **Multi-Slot** key described below. See [Figure 3-11 on page 177](#)

**Figure 3-11** EDGE Power vs. Time Result - Burst View



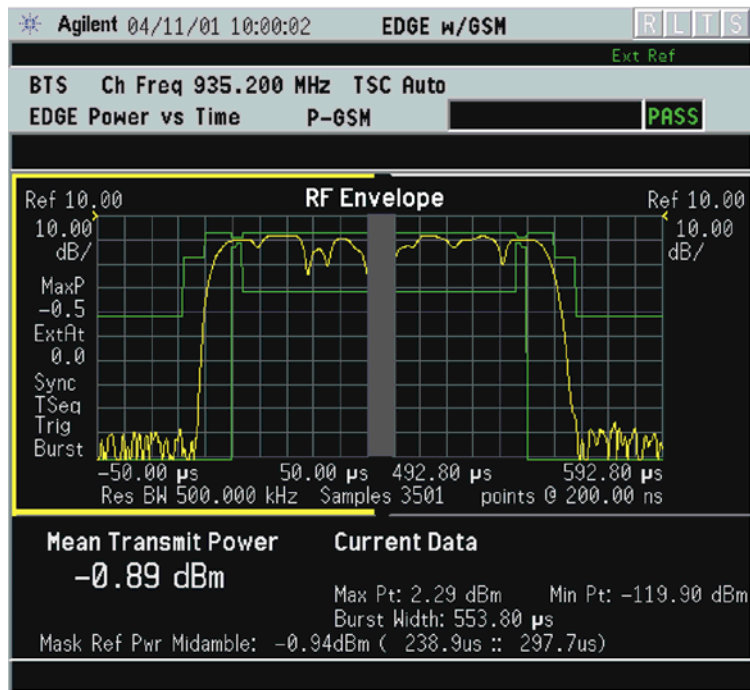
Key Reference  
Measurement Keys

- **Rise & Fall** - zooms in on the rising and falling portions of the burst being tested. See [Figure 3-12 on page 178](#).

## NOTE

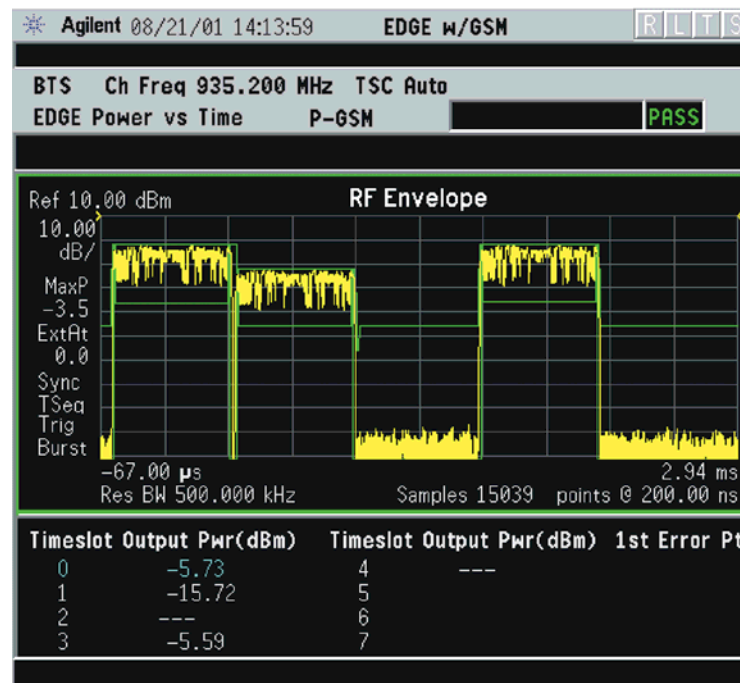
The limit test will still be performed on the entire burst (viewed using the **Burst** menu) when **Rise & Fall** is selected.

**Figure 3-12** EDGE Power vs. Time Result - Rise & Fall View



- **Multi-Slot** - views the entire sweep as specified by the current **Meas Time** setting. Power levels for each active slot are listed in a table below the timeslot display. Also shown in the table under **1st Error Pt.** is the point in time at which the signal level first exceeds the limit; this will help identify the slot where a failure first occurs. See [Figure 3-13 on page 179](#).

**Figure 3-13** EDGE Result - Multi-Slot View



Use the **Meas Time** key located in the **Meas Setup** menu to select up to eight slots. Use the **Timeslot** and **TSC** keys in the **Frequency/Channel** menu to select the slot you wish to activate. Setting **Timeslot** to **ON** and selecting a specific slot results in activating a measurement of that slot only (**Timeslot On** can be used to isolate a failure to a specific slot). When **Timeslot** is set to **OFF**, all active slots are tested against the mask.

Using a signal generator you can synchronize the multi-slot view so the frame (or portion of the frame) you are viewing starts with the slot you have selected. See [“EDGE Power vs. Time Measurement Concepts” on page 530](#).

You can switch from the multi-slot view directly to the burst or rise and fall views of the slot that is currently active. The **Scale/Div** key under the **Span/Y Scale** menu can be used to enlarge your view of this signal.

Key Reference

Measurement Keys

## Display Key Menu

Key Path: **Display**

The **Display** key will allow you to turn the limit mask on and off. This also disables the mask limit test, but still calculates the power in the useful part.

## EDGE Tx Band Spur Measurement Keys

---

**NOTE**

---

Make sure the EDGE Tx Band Spur measurement is selected under the **Measure** menu.

### Meas Setup Key Menu

Key Path: **Meas Setup**

- **Avg Number** - Allows you to select whether averages are made or not, and to change the number of N averages that are made.
- **Avg Mode Exp Repeat** - Allows you to choose either exponential or repeat averaging. This selection only effects the averaging after the number of N averages is reached (set using the **Averages**, **Avg Bursts**, or **Avg Number** key).
  - **Normal averaging**: Normal (linear) averaging is always used until the specified number of N averages is reached. When **Measure** is set at **Single**, data acquisitions are stopped when the number of averages is reached - thus **Avg Mode** has no effect on single measurements.
  - **Exponential averaging**: When **Measure** is set at **Cont**, data acquisitions will continue indefinitely. After N averages, exponential averaging is used with a weighting factor of N (the displayed average count stops at N). Exponential averaging weights new data more than old data, which allows tracking of slow-changing signals. The weighting factor N is set using the **Averages**, **Avg Bursts**, or Avg Number key.
  - **Repeat averaging**: When **Measure** is set at **Cont**, data acquisitions will continue indefinitely. After N averages is reached, all previous result data is cleared and the average count is set back to 1. This is equivalent to being in **Measure Single** and pressing the **Restart** key when the Single measurement finishes.
- **Avg Type** - Select the averaging type from the following selections: (Not all of the selections are available for all measurements)
  - Pwr Avg (RMS)** - True power averaging that is equivalent to taking the RMS value of the voltage. It is the most accurate type of averaging.
  - Log-Pwr Avg (Video)** - Simulates the traditional spectrum analyzer type of averaging by averaging the log of the power.
  - Mean** - Averages the mean values.
  - Voltage Avg** - Averages the voltage values.
  - Maximum** - Keeps track of the maximum values.
  - Minimum** - Keeps track of the minimum values.

**Max & Min** - Keeps track of the maximum and minimum values.

- **Meas Type**- Selects measurement style as defined by menu keys below:
  - **Full** - In Continuous Measure, the instrument repeatedly performs a full search of all segments.
  - **Examine**- In Continuous Measure, after doing one full search across all segments, the instrument parks on the worst segment and continuously updates that segment.
- **Limit** - set the absolute or relative limit. The limit range is from -200 dBm to 100 dBm.

**dBm** - Absolute limit

**dBc** - Relative to Mean Transmit Power.

**Table 3-8**

**EDGE Tx Band Spur Measurement Defaults**

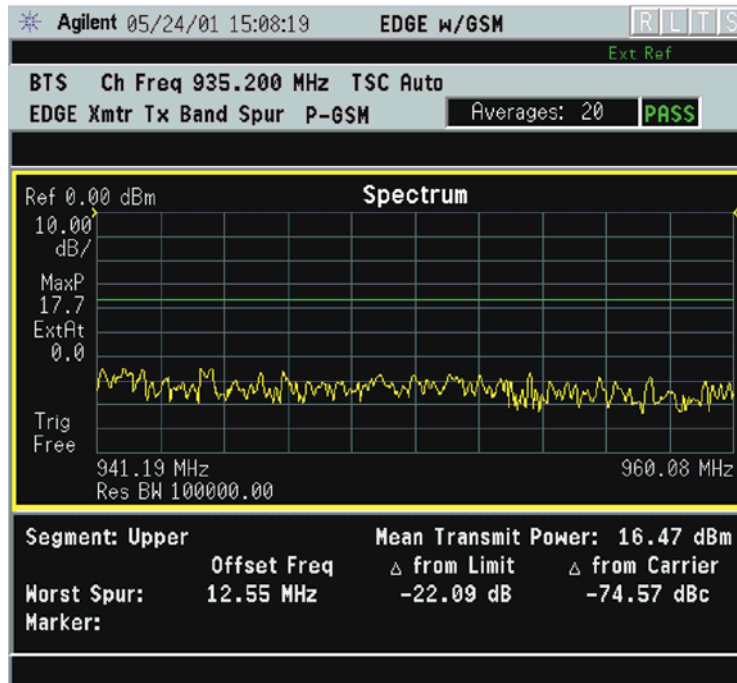
Measurement Parameter	Factory Default Condition
Avg Number	30 On
Avg Mode	Repeat
Avg Type	Maximum
Meas Type	Full
Limit	-36 dBm

### Trace/View Key Menu

Key Path: **Trace/View**

- **Lower Segment** - Select lower Tx band edge to -6 MHz offset from the channel frequency for display.
- **Lower Adj Segment** - Select -6 MHz to -1.8 MHz offset from the channel frequency for display.
- **Upper Adj Segment** - Select +1.8 MHz to +6 MHz offset from the channel frequency for display.
- **Upper Segment** - +6 MHz offset from the channel frequency to the upper Tx band edge for display.

**Results Figure 3-14 EDGE Tx Band Spur Result - Upper Adj Segment**



## GMSK Output RF Spectrum Measurement Keys

---

**NOTE** Make sure the Output RF Spectrum measurement is selected under the **Measure** menu.

---

### Meas Setup Key Menu

Key Path: **Meas Setup**

- **Avg Bursts On Off** - Allows you to select whether averages are made or not, and allows you to change the number of N averages that are made.
- **Meas Type** - accesses a menu to choose the measurement that is optimized for the type of spectral distortion being investigated.
  - **Mod & Switch** - will perform both Modulation and Switching measurements, which measures the spectrum due to the 0.3 GMSK modulation and noise, and also measures Switching (transient) spectrum.
  - **Modulation** - measures the spectrum optimized for distortion due to the 0.3 GMSK modulation and noise.
  - **Switching** - measures the spectrum optimized for distortion due to switching transients (burst ramping).
  - **Full Frame Modulation (FAST)**- improves measurement speed by acquiring a full frame of data prior to performing the FFT calculation. This feature can only be used when all slots in the transmitted frame are active. Use of an external trigger can enhance measurement speed when this feature is used. When **Full Frame Modulation (FAST)** is selected the current measurement defaults to the multi-offset measurement method; therefore the **Meas Method** key is grayed out and the **Single Offset** feature is not available.
- **Meas Method** - accesses a menu to choose the measurement mode.
  - **Multi-Offset** - automatically makes measurements at all offset frequencies in the selected list (**Standard**, **Short**, or **Custom**). (See table below.) Press the **Multi-Offset Freq List** key to select a list of offsets to measure.
  - **Single Offset (Examine)** - makes a measurement at a single offset frequency as set by the **Single Offset Freq** softkey.
  - **Swept** - makes a measurement using time-gated spectrum analysis to sweep the analyzer with the gate turned on for the desired portion of the burst only, as set by the **Modulation Ofs** (offsets) & **Limits** menu. This selection is only available if **Meas Type** is set to **Modulation**.



- **Multi-Offsets Freq List** - accesses a menu to choose a predefined offset frequency list. Select a **Standard**, **Short**, or **Custom** list as shown in the table below. This selection is only available if **Meas Method** is set to **Multi-Offset**.

List	Modulation Offsets (kHz)	Switching Transients Offsets (kHz)
<b>Standard</b>	100, 200, 250, 400, 600, 800, 1000, 1200, 1400, 1600, 1800, 3000, 6000	400, 600, 1200, 1800
<b>Short</b>	200, 250, 400, 600 1200, 1800	400, 600, 1200, 1800
<b>Custom</b>	User-defined list that specifies: Offset Freq, RES BW, Limit Offsets  Initialized to be the same as the standard list	User-defined list that specifies: Offset Freq, RES BW, Limit Offsets  Initialized to be the same as the standard list

- **Modulation Ofs & Limits** - accesses a menu to set offset frequencies and limits for Modulation measurements. Settings made in this menu do not modify the GSM/EDGE standard settings. This selection is only available if **Multi-Offset Freq List** is set to **Custom**.
  - **Offset** - Select an offset by letter designation from **A** to **O**
  - **Offset Freq** - Turn a custom frequency offset **ON** or **OFF** and specify the offset frequency.
  - **Res BW** - Set the custom resolution bandwidth of the measurement. Narrower **Res BW** settings will slow the measurement speed, but will give improved results for lower power signals.
  - **Rel Limit Level Offset** - Set a custom level limit offset from the standard-defined relative limit in dB. The range is +/- 50 dB.
  - **Abs Limit Level Offset** - Set a custom level limit offset from the standard-defined absolute limit in dB. The range is +/- 50 dB.
  - **Apply Level Offset** - Toggle this key to select which Limit Level Offsets are applied from the selections listed below:
    - Rel - Custom setting for **Rel Limit Level Offset** is applied to the standard-defined relative limit.
    - Abs - Custom setting for **Abs Limit Level Offset** is applied to the standard-defined absolute limit.
    - Both - Custom settings for **Rel Limit Level Offset** and **Abs Limit Level Offset** are applied.

- **Switching Offs & Limits Multi-Ofs Freq List** accesses a menu to set offset frequencies and limits for Custom Switching measurements. Settings made in this menu do not modify the GSM/EDGE standard settings. This selection is only available if **Multi-Offset Freq List** is set to **Custom**.
  - **Offset** - Select an offset by letter designation from **A** to **O**
  - **Offset Freq** - Turn a custom frequency offset **ON** or **OFF** and specify the offset frequency.
  - **Res BW** - Set the custom resolution bandwidth of the measurement. The default is 30 kHz. Narrower **Res BW** settings will slow the measurement speed, but will give improved results for lower power signals.
  - **Rel Limit Level Offset** - Set a custom level offset from the standard-defined relative limit in dB. The range is +/- 50 dB.
  - **Abs Limit Level Offset** - Set a custom level limit offset from the standard-defined absolute limit in dB. The range is +/- 50 dB.
  - **Apply Level Offset** - Toggle this key to select which Limit Level Offsets are applied from the selections listed below:
    - Rel - Custom setting for **Rel Limit Level Offset** is applied to the standard-defined relative limit.
    - Abs - Custom settings for **Abs Limit Level Offset** is applied to the standard-defined absolute limit.
    - Both - Custom settings for **Rel Limit Level Offset** and **Abs Limit Level Offset** are applied.
- **Offset Freq** - Only available when **Measure** is set to **Single Offset (Examine)**. Offset frequencies can be entered using the RPG knob or the Data Entry keys.
- **Trig Source** - in this measurement, trigger source and burst sync are linked. Refer to the explanation under **Burst Sync**.
- **Burst Sync** - Synchronization is different on ORFS compared to other measurements. Since offsets may be very low power and acquired using very narrow filters, the burst edges are not well defined and there certainly is not enough information to perform a demodulation. Therefore all synchronization is performed on the carrier. The timing reference ("T0") is then re-used on the offsets. Since "T0" on the carrier is determined with respect to the trigger point, the trigger point on the offsets is very important. Once "T0" is determined, the 50% and 90% points can be found.

Therefore, the trigger must be synchronous with respect to a rising edge of a burst. The RF Burst trigger will do this if the offset is within about 7 MHz of the carrier. Remember that since the RF Burst trigger is wideband, the carrier will still cause the signal to

trigger. Assuming the trigger threshold remains constant, the trigger with respect to the burst will remain constant. Since the Frame Trigger uses an internal frame timer (clock), its period is set so that it occurs synchronously with respect to the transmitting frame. If an external trigger is used, it is important that it is synchronous with the burst.

Because of these requirements, only the trigger source can be selected while the measurement selects the burst sync type based on the trigger source.

<b>Trigger Source</b>	<b>Measurement Defined Burst Sync</b>
Free Run	None
RF Burst	RF Amplitude
Ext Front	External
Ext Rear	External
Frame	Training Sequence

---

**NOTE**

Video trigger source is not allowed, because when the instrument is tuned to offset frequencies away from the carrier, the video trigger threshold will not be reached due to the low power level at the offset.

---

Key Reference  
Measurement Keys

- **Fast Avg** - Fast averaging is a technique developed by HP/Agilent. The GSM standard specifies 50% to 90% portion of the burst, excluding the midamble, be measured. Since most offsets are measured in a 30 kHz filter, there is a lot of variation from burst to burst, hence the averaging.

The fast average method makes use of the 10% to 90% portion of the burst, excluding the midamble. The 10% to 50% portion of the burst has statistically the same average power as the 50% to 90%. Therefore, measuring both portions from one burst is statistically the same as measuring 50% to 90% from two bursts. Now, two averages are completed with one burst. When averaging is turned on, this will double the speed of the measurement.

This method is only applicable on the modulation portion of the test, and only when averaging is enabled. The method is not available when Modulation and Switching are done at the same time.

- **Advanced** - accesses a menu with the following keys:

---

**NOTE**

Parameters under the Advanced key seldom need to be changed. Changes from default values may result in invalid measurement data.

— **Mod Avg** - choose between:

- Pwr Avg (RMS)**
- Log-Pwr Avg (Video)**

— **Switching Avg** - information only. When averaging is off, the peak value of the burst is retained. When averaging is on, the maximum of the peak values is retained.

— **Modulation Meas BWs** - accesses a menu with the following selections:

---

**NOTE**

Changing these RBW settings will modify standard-defined values. Changes to these settings will affect all EDGE ORFS measurements, except for Custom Multi-Offset measurements (where custom RBW setting in Modulation/Switching Ofs & Limits menu is used) and Modulation Swept measurements (where RBW is set to 30 kHz).

- Carrier RBW**
- <1800 kHz Offset RBW**
- >=1800 kHz Offset RBW**
- VBW/RBW Ratio** - information only. Bandwidth ratio is fixed at 1.

- **Switching Meas BWs** - accesses a menu with the following selections:
  - Carrier RBW**
  - <1800 kHz Offset RBW**
  - >=1800 kHz Offset RBW**
  - VBW/RBW Ratio** - information only. Switching ratio is fixed at 3.
- **Direct Time Break Freq** - Selects the transition frequency (the first offset frequency) where the Direct Time Domain method is used instead of the FFT method. The Direct Time Domain offers a high dynamic range and is faster for making measurements at a few offset frequencies. The FFT method has a moderate dynamic range (generally sufficient when the RBW = 30 kHz). It is much faster for measuring at many offset frequencies
- **Fast Peak Det** - Improves measurement speed by utilizing the running peak measurement capability of the DSP hardware without calculating averages separately. The previous method may be used for backwards compatibility by turning **Fast Peak Det** off.

Table 3-9

**Output RF Spectrum Measurement Defaults**

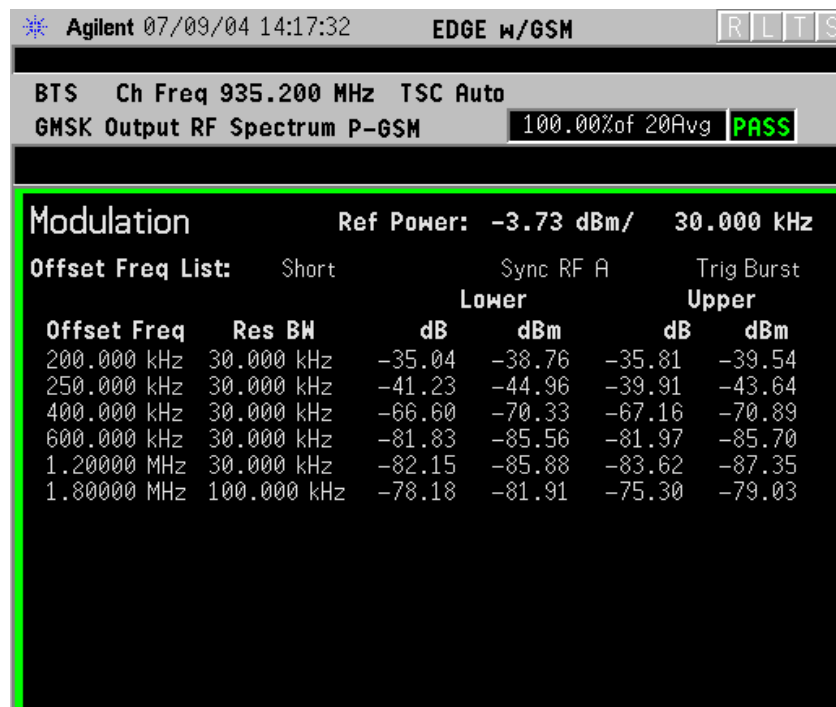
Measurement Parameter	Factory Default Condition
Avg Bursts	20 On
Avg Mode	Repeat
Meas Method	Multi-Offset
Meas Type	Modulation
Ofs Freq List	Short
Offset Freq (when single offset is selected)	250.000 kHz
Trig Source	RF Burst
Burst Sync (information only)	RF Amptd
Fast Avg	On
Mod Method	Discrete
<b>Advanced</b>	
Mod Avg	Log-Pwr Avg (Video)
Switching Avg (information only)	Max of Peak
Direct Time Break Freq	600.000 kHz
Fast Peak Det	On
Modulation Meas BWs	
Carrier RBW	30.000 kHz
<1800 kHz Offset RBW	30.000 kHz
≥1800 kHz Offset RBW	100.000 kHz
VBW/RBW Ratio (information only)	1
Switching Meas BWs	
Carrier RBW	300.000 kHz
<1800 kHz Offset RBW	30.000 kHz
≥1800 kHz Offset RBW	30.000 kHz
VBW/RBW Ratio (information only)	3

### Trace/View Key Menu

Key Path: Trace/View

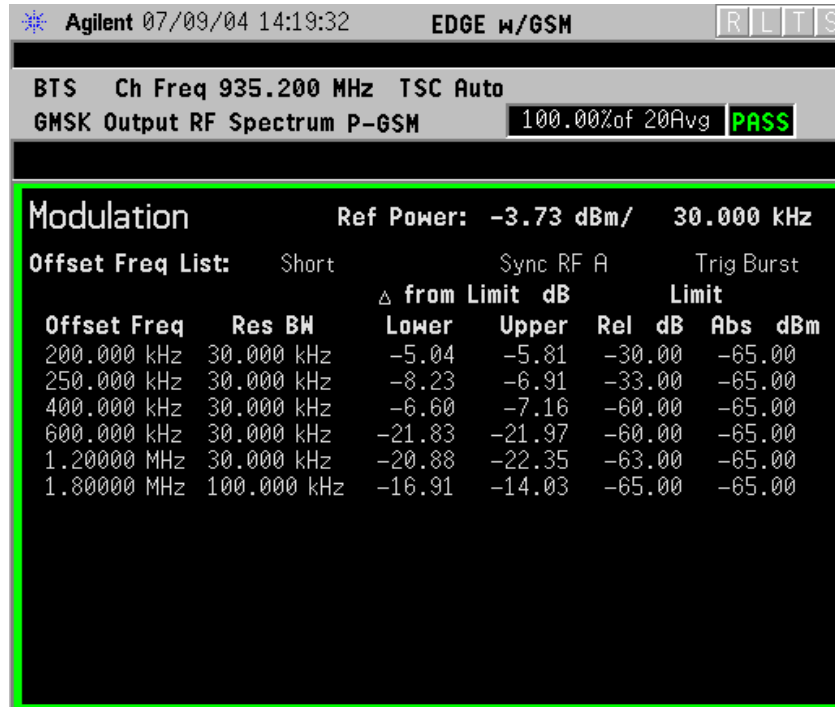
- **Modulation Power** - When **Meas Method** is set to **Multi-Offset**, and **Meas Type** is set to **Modulation**, or **Mod and Switch**, measurement results may be viewed as absolute powers in tabular form. The data will display offsets from any of the the **Multi-Offset Freq List** settings: **Standard**, **Short**, and **Custom**.

**Figure 3-15 GMSK ORFS Result - Example (Short List)  
Modulation Power View**



- **Modulation Margins & Limits-** When **Meas Method** is set to **Multi-Offset**, and **Meas Type** is set to **Modulation**, or **Mod and Switch**, measurement results may be viewed as relative powers in tabular form. The data will display offsets from any of the the **Multi-Offset Freq List** settings: **Standard**, **Short**, and **Custom**, and shows the limit values selected by frequency, with the corresponding measurement result deltas.

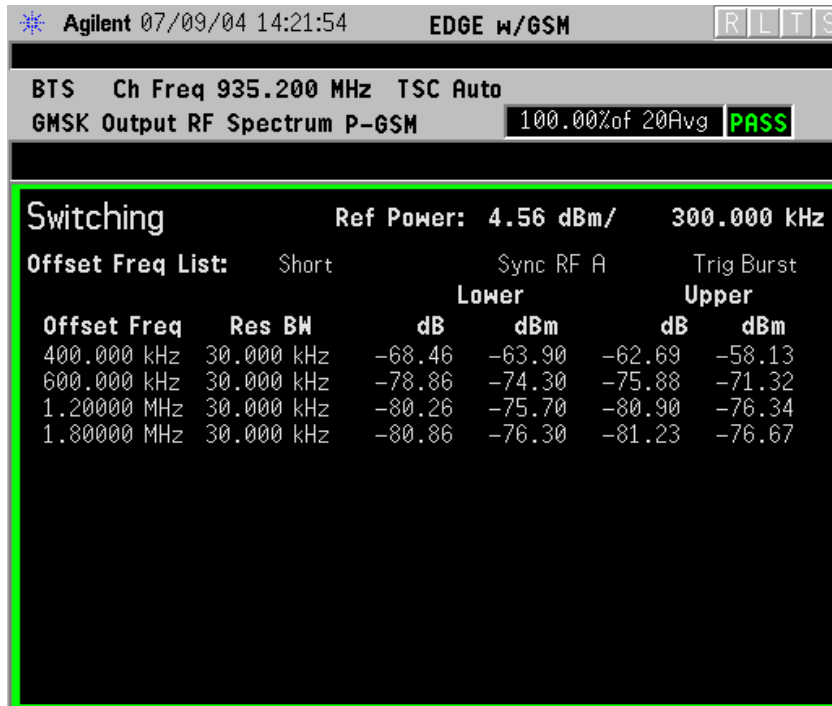
**Figure 3-16** GMSK ORFS Result - Example (Short List)  
Modulation Margin & Limits View





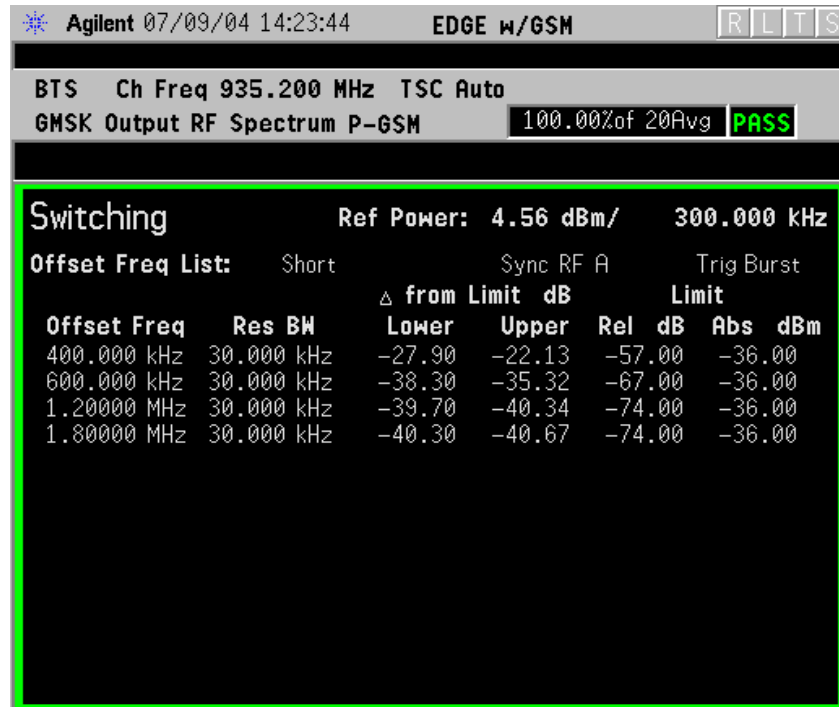
- **Switching Power** - When **Meas Method** is set to **Multi-Offset**, and **Meas Type** is set to **Switching**, or **Mod and Switch**, measurement results may be viewed as absolute powers in tabular form. The data will display offsets from any of the the **Multi-Offset Freq List** settings: **Standard**, **Short**, and **Custom**.

**Figure 3-17 GMSK ORFS Result - Example (Short List) Switching Power View**



- **Switching Margins & Limits**- When **Meas Method** is set to **Multi-Offset**, and **Meas Type** is set to **Switching** or **Mod and Switch**, measurement results may be viewed as relative powers in tabular form. The data will display offsets from any of the the **Multi-Offset Freq List** settings: **Standard**, **Short**, and **Custom**, and shows the limit values selected by frequency, with the corresponding measurement result deltas.

**Figure 3-18** GMSK ORFS Result - Example (Short List)  
Switching Margin & Limits View



**NOTE**

If the Single Offset measurement has been chosen, the **Trace/View** softkey is unavailable (grayed out) as both modulation and switching results are always displayed.

## GMSK Phase and Frequency Error Measurement Keys

---

**NOTE**

This measurement is designed for GSM only.

Make sure the **GMSK Phase and Freq** measurement is selected under the **Measure** menu.

---

### Meas Setup Key Menu

Key Path: **Meas Setup**

- **Avg Bursts On Off** - Allows you to select whether averages are made or not, and allows you to change the number of N averages that are made.
- **Avg Mode Exp Repeat** - Allows you to choose either exponential or repeat averaging. This selection only effects the averaging after the number of N averages is reached (set using the **Averages**, **Avg Bursts**, or **Avg Number** key).
  - **Normal averaging**: Normal (linear) averaging is always used until the specified number of N averages is reached. When **Measure** is set at **Single**, data acquisitions are stopped when the number of averages is reached - thus **Avg Mode** has no effect on single measurements.
  - **Exponential averaging**: When **Measure** is set at **Cont**, data acquisitions will continue indefinitely. After N averages, exponential averaging is used with a weighting factor of N (the displayed average count stops at N). Exponential averaging weights new data more than old data, which allows tracking of slow-changing signals. The weighting factor N is set using the **Averages**, **Avg Bursts**, or **Avg Number** key.
  - **Repeat averaging**: When **Measure** is set at **Cont**, data acquisitions will continue indefinitely. After N averages is reached, all previous result data is cleared and the average count is set back to 1. This is equivalent to being in **Measure Single** and pressing the **Restart** key when the Single measurement finishes.
- **Avg Type** - Select the averaging type from the following selections: (Not all of the selections are available for all measurements)
  - **Pwr Avg (RMS)** - True power averaging that is equivalent to taking the RMS value of the voltage. It is the most accurate type of averaging.
  - **Log-Pwr Avg (Video)** - Simulates the traditional spectrum analyzer type of averaging by averaging the log of the power.
  - **Mean** - Averages the mean values.

Key Reference  
Measurement Keys

- Voltage Avg - Averages the voltage values.
- **Maximum** - Keeps track of the maximum values.
- **Minimum** - Keeps track of the minimum values.
- **Max & Min** - Keeps track of the maximum and minimum values.
- **Limits** - Select custom values for limits from the following selections:

---

**NOTE**

The selections available for custom limits depend on the settings for **Radio**, **Device** and if **BTS** is selected, for **BTS Type**.

- **RMS Phase Error** - Select a value for RMS Phase Error limit in degrees.
- **Peak Phase Error** - Select a value for Peak Phase Error limit in degrees.
- **Freq Error** - Select a value for Frequency Error limit in ppm.
- **Trig Source Key Menu**

---

**NOTE**

Changing the selection in the **Trig Source** menu alters the trigger source for the selected measurement only.

- **Free Run (Immediate)** - The trigger occurs at the time the data is requested, completely asynchronous to the RF or IF signal.
- **RF Burst (Wideband)** - An internal wideband RF burst trigger that has an automatic level control for burst signals. It triggers on a level that is relative to the peak of the signal passed by the RF. If the data sent is all 0 bits, this trigger will give erratic or falsely high EVM results.
- **Video (IF Envp)** - An internal IF envelope trigger. It triggers on an absolute threshold level of the signal passed by the IF.
- **Ext Front** - Activates the front panel external trigger input (**EXT TRIGGER INPUT**). The external trigger must be a signal between -5 and +5 volts.
- **Ext Rear** - Activates the rear panel external trigger input (**TRIGGER IN**). The external trigger must be a signal between -5 and +5 volts.
- **Frame** - Uses the internal frame clock to generate a trigger signal. The clock parameters are controlled under the **Mode Setup** key or the measurement firmware, but not both. See the specific measurement for details.
- **Line** - activates an internal line trigger. Sweep triggers occur at intervals synchronized to the line frequency.

**NOTE**

Rear panel **TRIGGER 1 OUT** and **TRIGGER 2 OUT** connectors are coupled to the selected trigger source. These trigger outputs are always on the rising edge with a pulse width of at least 1  $\mu$ s.

- **Burst Sync** - pressing the **Burst Sync** key allows you to choose the source used to synchronize the measurement to the “T0” point of the GSM or EDGE burst. The “T0” point is defined as the time point of the transition from bit 13 to bit 14 of the midamble training sequence for a given time slot. The **Burst Search Threshold** setting (in the **Mode Setup** keys under **Trigger**) applies to both **Training Seq** and **RF Amptd**.
  - **Training Seq** - Synchronizes the measurement to the timing of the demodulated training sequence in the GSM burst. This is the most precise method, but requires a GMSK or EDGE burst with a valid TSC (Training Sequence Code). The “T0” point is determined by demodulation of the burst and successful identification of the TSC. “T0” is then found to within 1/10 bit.
  - **RF Amptd** - Synchronizes the measurement to the burst transition of the measured RF carrier. “T0” is set to the 50% point between the start and end of the burst.
- **Trace Data ON/OFF**- When Trace Data is set to On, I/Q trace data are shown as well as Phase and Frequency error trace data, but the measurement takes a little longer. Turn Trace Data Off to improve measurement speed.
- **I/Q Origin Offset Meas ON/OFF** - When I/Q Origin Offset Meas set to On, the measurement is performed and the result shown.

**Table 3-10**

**Phase and Frequency Error Measurement Defaults**

Measurement Parameter	Factory Default Condition
Avg Bursts	10 Off
Avg Mode	Repeat
Avg Type	Maximum
Limits	
RMS Phase Error	5 deg
Peak Phase Error	20 deg
Freq Error	
Base, Normal, Micro	0.05 ppm
Base, Pico	0.1 ppm
Base, Mobile	0.1 ppm
Trig Source	RF Burst (Wideband)
Burst Sync	Training Sequence

Table 3-10

## Phase and Frequency Error Measurement Defaults

Measurement Parameter	Factory Default Condition
Trace Data	On
I/Q Origin Offset Meas	On

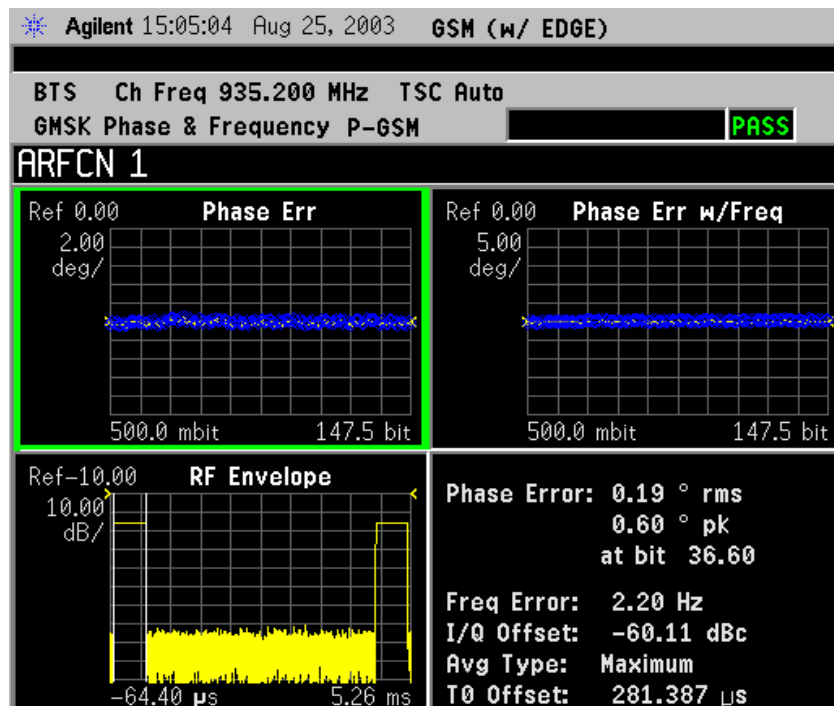
## Trace/View Key Menu

Key Path: Trace/View

The **Trace/View** key will allow you to select the desired view of the measurement from the following:

- **I/Q Error (Quad-View)** - Provides a combination view including
  - Window 1: Phase Error
  - Window 2: Phase Error with Freq
  - Window 3: RF Envelope
  - Window 4: Numeric Results, including Trigger to T0 measurement, and demodulated bits

**Figure 3-19** GMSK Phase and Frequency Error Result - I/Q Error (Quad View)



## NOTE

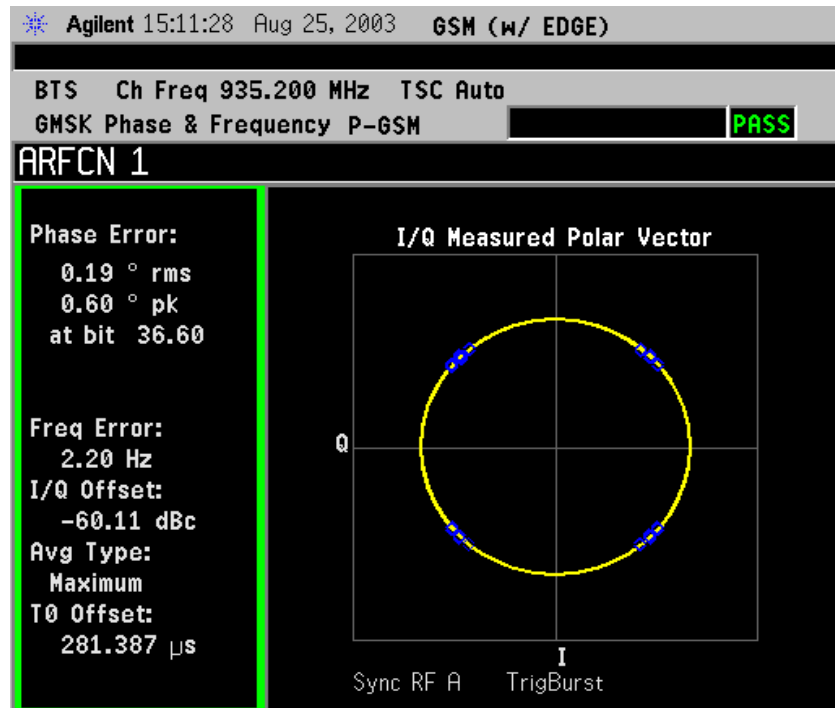
Any of these windows can be selected (using the **Next Window** key) and made full size (using the **Zoom** key).

- **I/Q Measured Polar Vector** - Provides a view of numeric results and a polar vector graph.

Window 1: Numeric Results

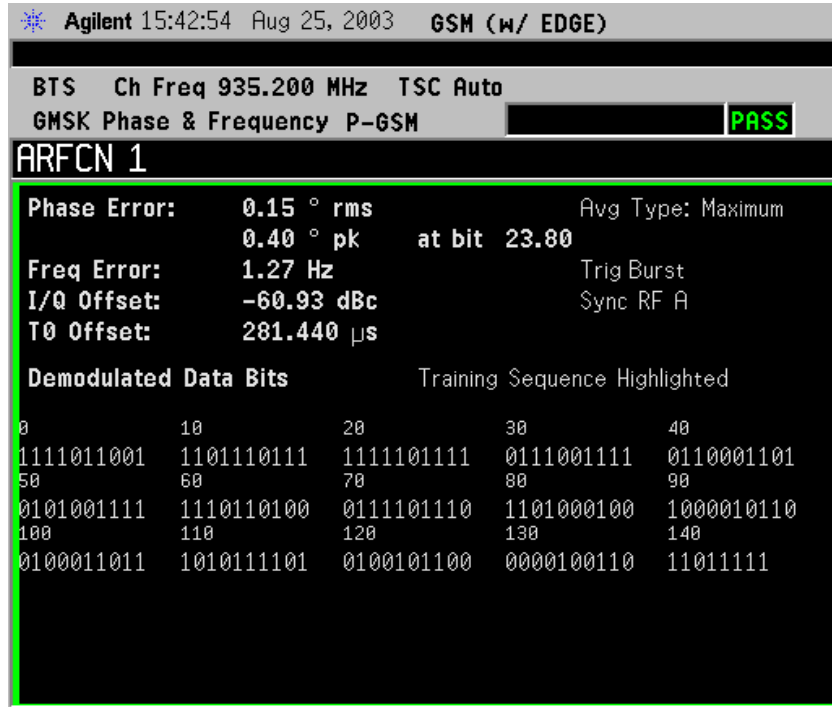
Window 2: Polar Vector Graph

**Figure 3-20** GSM Phase and Frequency Error Result - Polar Vector View



- **Data Bits** - Provides a view of the numeric results and data bits with the sync word (TSC) highlighted.

**Figure 3-21** GMSK Phase and Frequency Error Result - Data Bits



**NOTE**

The menus under the **Span X Scale** and **Amplitude Y Scale** keys are context dependent upon the selected window (graph type). The **Span X Scale** parameters will be in units of time or bits, dependent on the view selected. The **Amplitude Y Scale** parameters will be in units of dB or degrees, dependent on the view selected. All of the softkey labels are blank when **I/Q Measured Polar Vector**, or **Data Bits** are selected.

**Display Menu Keys**

Key Path: **Display**

The **Display** key will allow you to turn the bit dots on and off.



## GMSK Power vs. Time Measurement Keys

---

**NOTE** Make sure the **GMSK Pwr vs Time** measurement is selected under the **Measure** menu.

---

### Meas Setup Key Menu

Key Path: **Meas Setup**

- **Avg Bursts On/Off** - Allows you to select whether averages are made or not, and allows you to change the number of N averages that are made.
- **Avg Mode Exp Repeat** - Allows you to choose either exponential or repeat averaging. This selection only effects the averaging after the number of N averages is reached (set using the **Averages**, **Avg Bursts**, or **Avg Number** key).
  - **Normal averaging**: Normal (linear) averaging is always used until the specified number of N averages is reached. When **Measure** is set at **Single**, data acquisitions are stopped when the number of averages is reached - thus **Avg Mode** has no effect on single measurements.
  - **Exponential averaging**: When **Measure** is set at **Cont**, data acquisitions will continue indefinitely. After N averages, exponential averaging is used with a weighting factor of N (the displayed average count stops at N). Exponential averaging weights new data more than old data, which allows tracking of slow-changing signals. The weighting factor N is set using the **Averages**, **Avg Bursts**, or **Avg Number** key.
  - **Repeat averaging**: When **Measure** is set at **Cont**, data acquisitions will continue indefinitely. After N averages is reached, all previous result data is cleared and the average count is set back to 1. This is equivalent to being in **Measure Single** and pressing the **Restart** key when the Single measurement finishes.
- **Avg Type** - Select the averaging type from the following selections: (Not all of the selections are available for all measurements)
  - Pwr Avg (RMS)** - True power averaging that is equivalent to taking the RMS value of the voltage. It is the most accurate type of averaging.
  - Log-Pwr Avg (Video)** - Simulates the traditional spectrum analyzer type of averaging by averaging the log of the power.
  - Mean** - Averages the mean values.
  - Voltage Avg** - Averages the voltage values.
  - Maximum** - Keeps track of the maximum values.

**Minimum** - Keeps track of the minimum values.

**Max & Min** - Keeps track of the maximum and minimum values.

- **Meas Time** - allows you to measure more than one timeslot. Enter a value in integer increments of “slots” with a range of 1 to 8. The actual measure time in  $\mu\text{s}$  is set somewhat longer than the specified number of slots in order to view the complete burst.
- **Trig Source Key Menu**

Changing the selection in the **Trig Source** menu alters the trigger source for the selected measurement only. Not all of the selections are available for all measurements. Note that the **RF Burst (Wideband)**, **Video (IF Envlp)**, **Ext Front**, and **Ext Rear** menu keys found in the **Trigger** menu enable you to change settings to modify the delay, level, and slope for each of these trigger sources.

- **Free Run (Immediate)** - The trigger occurs at the time the data is requested, completely asynchronous to the RF or IF signal.
- **RF Burst (Wideband)** - An internal wideband RF burst trigger that has an automatic level control for burst signals. It triggers on a level that is relative to the peak of the signal passed by the RF. If the data sent is all 0 bits, this trigger will give erratic or falsely high EVM results.
- **Video (IF Envlp)** - An internal IF envelope trigger. It triggers on an absolute threshold level of the signal passed by the IF.
- **Ext Front** - Activates the front panel external trigger input (**EXT TRIGGER INPUT**). The external trigger must be a signal between  $-5$  and  $+5$  volts.
- **Ext Rear** - Activates the rear panel external trigger input (**TRIGGER IN**). The external trigger must be a signal between  $-5$  and  $+5$  volts.
- **Frame** - Uses the internal frame clock to generate a trigger signal. The clock parameters are controlled under the **Mode Setup** key or the measurement firmware, but not both. See the specific measurement for details.
- **Line** - activates an internal line trigger. Sweep triggers occur at intervals synchronized to the line frequency.

Rear panel **TRIGGER 1 OUT** and **TRIGGER 2 OUT** connectors are coupled to the selected trigger source. These trigger outputs are always on the rising edge with a pulse width of at least 1  $\mu$ s.

- **Burst Sync Key Menu**

Pressing the **Burst Sync** key allows you to choose the source used to synchronize the measurement to the “T0” point of the GSM or EDGE burst. The “T0” point is defined as the time point of the transition from bit 13 to bit 14 of the midamble training sequence for a given time slot. The **Burst Search Threshold** setting (in the **Mode Setup** keys under **Trigger**) applies to both **Training Seq** and **RF Amptd**. Pressing the **Burst Sync** key will bring up a menu with some or all of the following choices:

- **Training Seq** - Synchronizes the measurement to the timing of the demodulated training sequence in the GSM burst. This is the most precise method, but requires a GMSK or EDGE burst with a valid TSC (Training Sequence Code). The “T0” point is determined by demodulation of the burst and successful identification of the TSC. “T0” is then found to within 1/10 bit.
  - **RF Amptd** - Synchronizes the measurement to the burst transition of the measured RF carrier. “T0” is set to the 50% point between the start and end of the burst.
  - **None** - The start of the time record is the start of the measured data. Set **Trigger Delay** as needed to capture the data to be measured.
- **Pwr Cntrl Lvl** - used to indicate the output power of the transmitter; in MS testing transmitter output power variations will affect the mask (in BTS testing the mask is unaffected). The appropriate power level for measuring the device under test will correspond with the transmitter power control level setting. This key is only available if **Limit Mask** is set to **Standard**.
  - **Advanced** - accesses a menu to change the following parameters:

---

**NOTE**

Parameters that are under the Advanced key seldom need to be changed. Any changes from the default values may result in invalid measurement data.

---

- **RBW Filter** - chooses the type of filter, either **Gaussian** or **Flat** (Flatop). Gaussian is the best choice when looking at the overall burst or the rising and falling edges, as it has excellent pulse response. If you want to precisely examine just the useful part of the burst, choose **Flat**.
- **Res BW** - sets the resolution bandwidth.
- **Timeslot Length** - Timeslot configurations can appear in two forms.

When making Multi-slot measurements, select a type of timeslot length configuration from the following list:

- **All 156.25 symb** - a uniform limit mask of 156.25 symbols in length is applied to all slots.
- **157/156 symb** - a limit mask of 157 symbols in length is applied to slots 0 and 4, while a limit mask of 156 symbols in length is applied to slots 1, 2, 3, 5, 6 and 7.

Table 3-11

Power vs. Time Measurement Defaults

Measurement Parameter	Factory Default Condition
Avg Bursts	10 Off
Avg Mode	Exp
Avg Type	Pwr Avg (RMS)
Meas Time	1 Slot
Timeslot	0 Off
Trig Source	RF Burst (Wideband)
Burst Sync	Training Seq
<b>Advanced</b>	
RBW Filter	Gaussian
Res BW	500.000 kHz

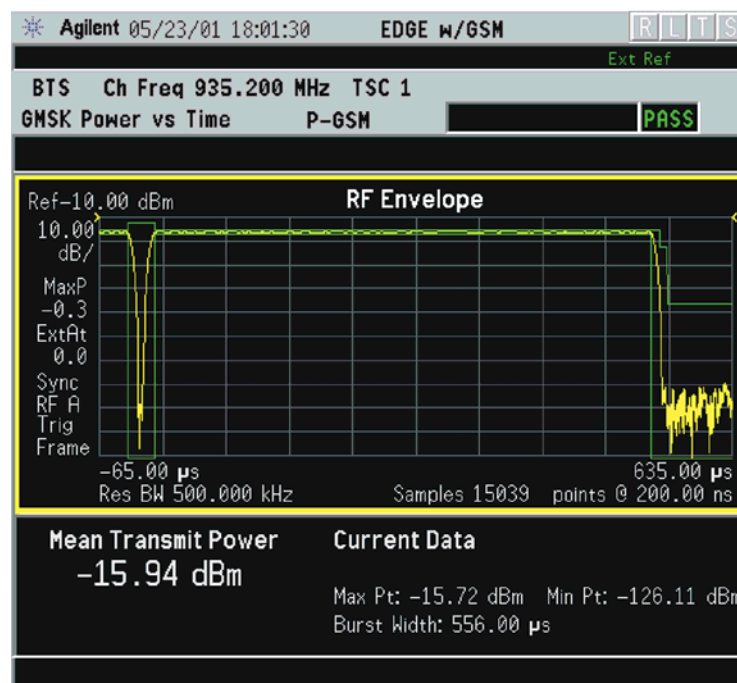
## Trace/View Menu Keys

Key Path: **Trace/View**

The **Trace/View** key accesses a menu that allows you to select the desired view of the measurement from the following selections:

- **Burst** - Select Burst View, which views the entire burst of interest as determined by the current trigger source, burst sync, training sequence, and timeslot settings. To view a different burst of interest you must set these parameters for the selected timeslot. To view multiple slots use the **Multi-Slot** key described below. See **Figure 3-22, “GMSK Power vs. Time Result - Burst View,”** below.

**Figure 3-22 GMSK Power vs. Time Result - Burst View**



**NOTE**

The limit test will still be performed on the entire burst (viewed using the **Burst** menu) when **Rise & Fall** is selected.

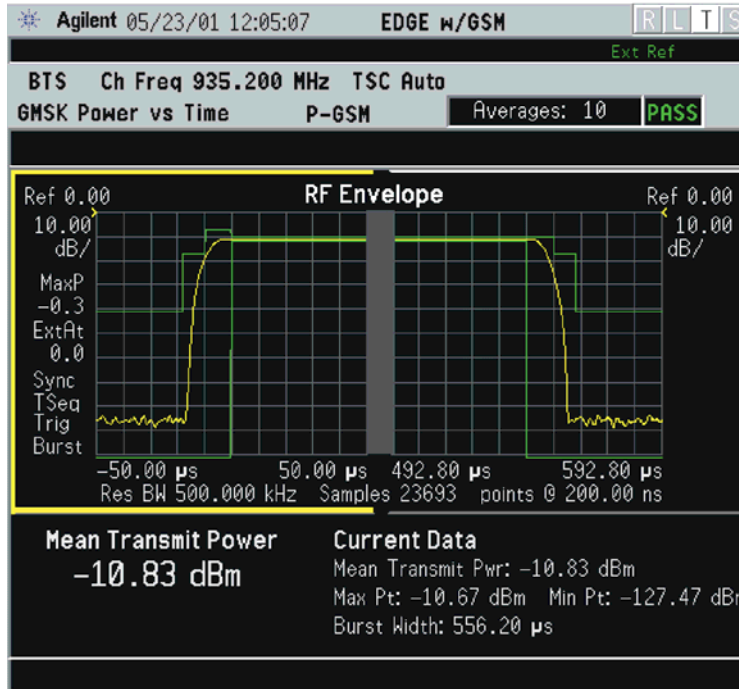
Information shown in the left margin of the displays include:

- **MaxP** - This is total input power allowed for the measurement. This value is coupled to the internal RF **Input Atten** setting.
- **ExtAt** - This value reflects the **External RF Atten** setting.
- **Sync** - The **Burst Sync** setting used in the current measurement
- **Trig** - The **Trigger Source** setting used in the current measurement

Key Reference  
Measurement Keys

- **Rise & Fall** - Select Rise & Fall View, which zooms in on the rising and falling portions of the burst being tested.

**Figure 3-23** GMSK Power vs. Time Result - Rise & Fall View



The **Mean Transmit Power** is displayed at the bottom left of the Burst and Rise & Fall views:

**Mean Transmit Power** - This is the RMS average power across the “useful” part of the burst, or the 147 bits centered on the transition from bit 13 to bit 14 (the “T0” time point) of the 26 bit training sequence. An RMS calculation is performed and displayed regardless of the averaging mode selected for the trace data.

**NOTE**

If Averaging = ON, the result displayed is the RMS average power of all bursts measured. If Averaging = OFF, the result is the RMS average power of the single burst measured. This is a different measurement result from Mean Transmit Pwr, below.

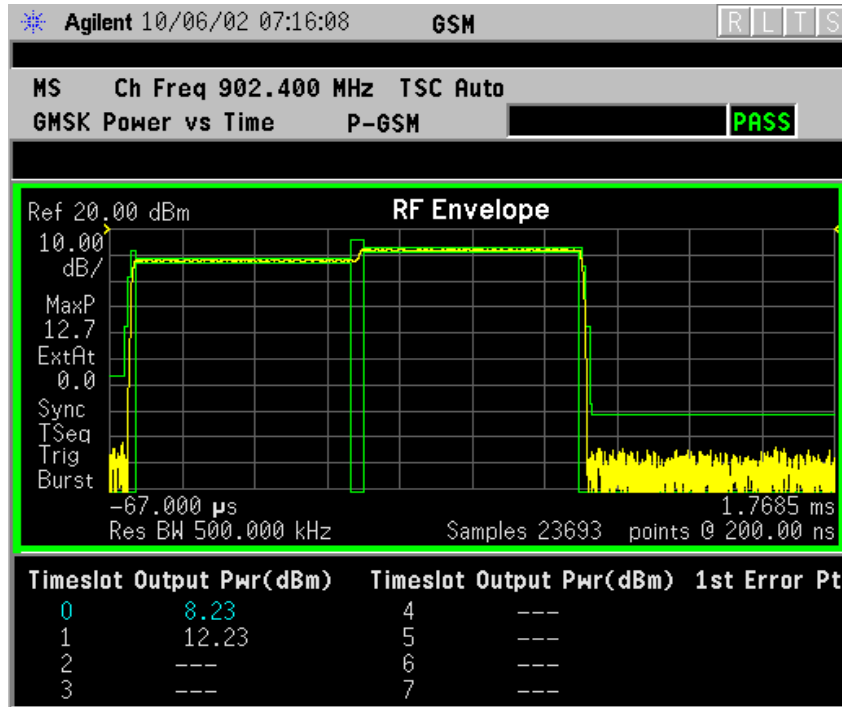
The **Current Data** displayed at the bottom of the Burst and Rise & Fall views include:

- **Mean Transmit Pwr** - This result appears only if Averaging = ON. It is the RMS average of power across the “useful” part of the burst, for the current burst only. If a single measurement of “n” averages has been completed, the result will indicate the Mean Transmit Pwr of the last burst. The RMS calculation is performed and displayed regardless of the averaging mode selected for the trace data. This is a different measurement result from Mean Transmit Power, above.
- **Max Pt.** - Maximum signal power point in dBm
- **Min Pt.** - Minimum signal power point in dBm
- **Burst Width** - Time duration of burst at -3 dB power point (half-power)
- **Mask Ref Pwr Midamble** - The Mask Reference Power is the average power in dBm of the middle 16 symbols in the midamble. The times displayed are the corresponding start and stop times of the middle 16 symbols.
- **1st Error Pt** - (Error Point) The time (displayed in ms or  $\mu$ s) indicates the point on the X Scale where the first failure of a signal was detected. Use a marker to locate this point in order to examine the nature of the failure.

Key Reference  
Measurement Keys

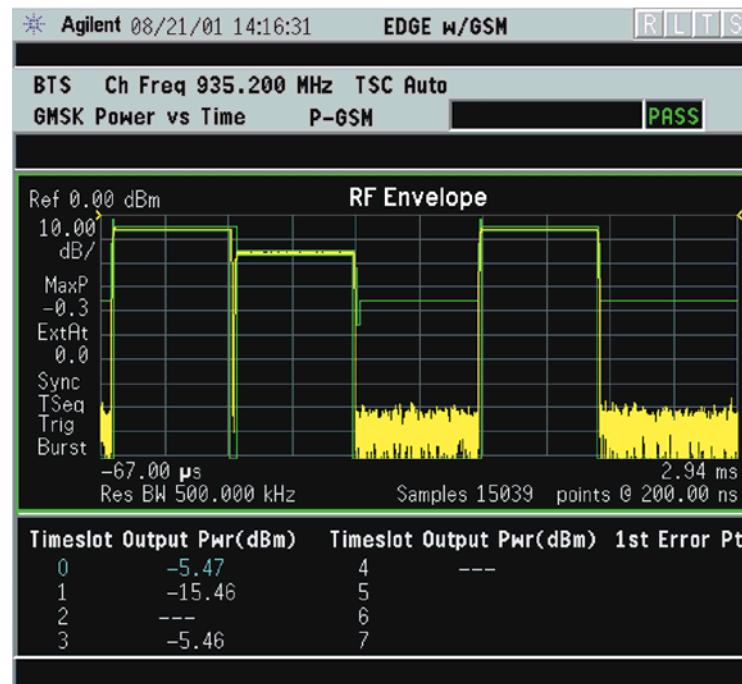
- **Multi-Slot** - Select Multi-Slot View, which views the entire sweep as specified by the current **Meas Time** setting. Power levels for each active slot are listed in a table below the timeslot display. Also shown in the table under **1st Error Pt.** is the point in time at which the signal level first exceeds the limit; this will help identify the slot where a failure first occurs.

**Figure 3-24** GPRS Power vs. Time Result - Multi-Slot View (2 slots shown)





**Figure 3-25** GMSK Power vs. Time Result - Multi-Slot View  
(5 slots shown)



The table in the lower portion of the multi-slot view shows the output power in dBm for each timeslot, as determined by the integer (1 to 8) entered in the **Meas Setup, Meas Time** setting. Output power levels are presented for the active slots; a dashed line will appear for any slot that is inactive. The timeslot that contains the burst of interest is highlighted in blue.

Use the **Meas Time** key located in the **Meas Setup** menu to select up to eight slots. Use the **Timeslot** and **TSC** keys in the **Frequency/Channel** menu to select the slot you wish to activate. Setting **Timeslot** to **ON** and selecting a specific slot results in activating a measurement of that slot only (**Timeslot On** can be used to isolate a failure to a specific slot). When **Timeslot** is set to **OFF**, all active slots are tested against the mask.

Using a signal generator you can synchronize the multi-slot view so the frame (or portion of the frame) you are viewing starts with the slot you have selected. See [“GMSK Power vs. Time Measurement Concepts” on page 515](#).

You can switch from the multi-slot view directly to the burst or rise and fall views of the slot that is currently active. The **Scale/Div** key under the **Span/Y Scale** menu can be used to enlarge your view of this signal.

Key Reference

Measurement Keys

## Display Menu Keys

Key Path: **Display**

- **Limit Mask ON/OFF** - The **Display** key will allow you to turn the limit mask on and off. This also disables the mask limit test, but still calculates the power in the useful part.

## GMSK Tx Band Spur Measurement Keys

---

**NOTE** Make sure the Tx Band Spur measurement is selected under the **Measure** menu.

---

### Meas Setup Key Menu

Key Path: **Meas Setup**

- **Averages, Avg Bursts On Off** and **Avg Number** - Allow you to change the number of N averages that are made. **Avg Number** - Also allows you to select whether averages are made or not.
- **Avg Mode Exp Repeat** - Allows you to choose either exponential or repeat averaging. This selection only effects the averaging after the number of N averages is reached (set using the **Averages, Avg Bursts**, or **Avg Number** key).
  - **Normal averaging:** Normal (linear) averaging is always used until the specified number of N averages is reached. When **Measure** is set at **Single**, data acquisitions are stopped when the number of averages is reached - thus **Avg Mode** has no effect on single measurements.
  - **Exponential averaging:** When **Measure** is set at **Cont**, data acquisitions will continue indefinitely. After N averages, exponential averaging is used with a weighting factor of N (the displayed average count stops at N). Exponential averaging weights new data more than old data, which allows tracking of slow-changing signals. The weighting factor N is set using the **Averages, Avg Bursts**, or **Avg Number** key.
  - **Repeat averaging:** When **Measure** is set at **Cont**, data acquisitions will continue indefinitely. After N averages is reached, all previous result data is cleared and the average count is set back to 1. This is equivalent to being in **Measure Single** and pressing the **Restart** key when the Single measurement finishes.
- **Avg Type** - Select the averaging type from the following selections: (Not all of the selections are available for all measurements)
  - **Pwr Avg (RMS)** - True power averaging that is equivalent to taking the RMS value of the voltage. It is the most accurate type of averaging.
  - **Log-Pwr Avg (Video)** - Simulates the traditional spectrum analyzer type of averaging by averaging the log of the power.
  - **Mean** - Averages the mean values.
  - **Voltage Avg** - Averages the voltage values.
  - **Maximum** - Keeps track of the maximum values.

## Key Reference

## Measurement Keys

- **Minimum** - Keeps track of the minimum values.
- **Max & Min** - Keeps track of the maximum and minimum values.
- **Meas Type** - select the measurement type from the following selections:
  - **Full** - In Continuous Measure, it repeatedly does full search of all segments.
  - **Examine** - In Continuous Measure, after doing one full search across all segments, it parks on the worst segment and continuously updates that segment.
- **Limit** - set the absolute or relative limit. The limit range is from -200 dBm to 100 dBm.
  - **dBm** - Absolute limit
  - **dBc** - Relative to Mean Transmit Power.

Table 3-12

## Tx Band Spur Measurement Defaults

Measurement Parameter	Factory Default Condition
Avg Number	30 On
Avg Mode	Repeat
Avg Type	Maximum
Meas Type	Full
Limit	-36 dBm

## Trace/View Menu Keys

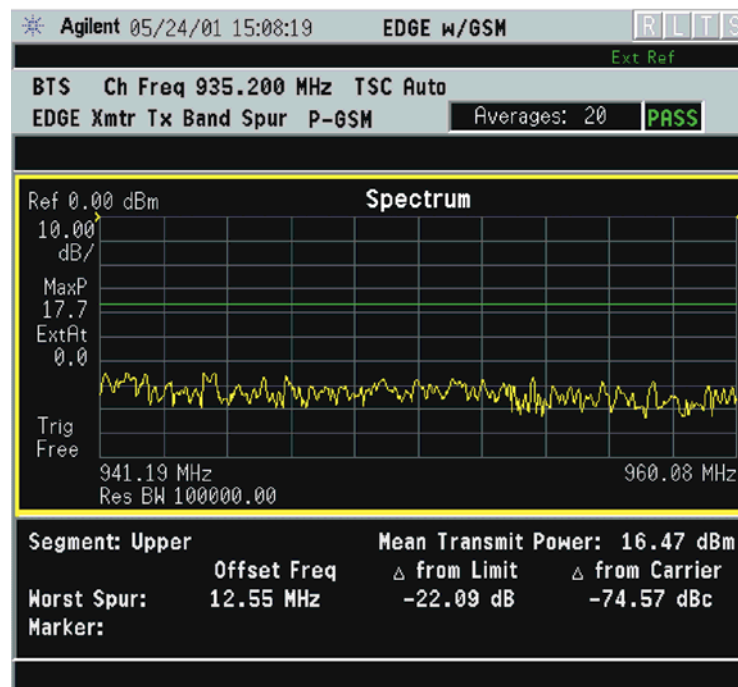
Key Path: **Trace/View**

The **Trace/View** key will allow you to further examine the desired spectrum segment. Each of these choices selects a different part of the frequency spectrum for viewing:

- **Lower Segment** - Select lower Tx band edge to -6 MHz offset from the channel frequency for display.
- **Lower Adj Segment** - Select -6 MHz to -1.8 MHz offset from the channel frequency for display.
- **Upper Adj Segment** - Select +1.8 MHz to +6 MHz offset from the channel frequency for display.
- **Upper Segment** - +6 MHz offset from the channel frequency to the upper Tx band edge for display.

Figure 3-26

### EDGE Tx Band Spur Result - Upper Adj Segment



---

## Spectrum (Frequency Domain) Keys

---

**NOTE** You must have selected **Spectrum** under the **MEASURE** menu to access these menus

---

### Meas Setup Key Menu

Key Path: **Meas Setup**

- **Span** - Modifies the frequency span. The range is 10 Hz to 10 MHz with 1 Hz resolution, depending on the **Res BW** setting. Changing the span causes the resolution bandwidth to change automatically, and will affect data acquisition time. For PSA Option 122 wideband operation the maximum span is 80 MHz.
- **Res BW** - Sets the resolution bandwidth for the FFT, and to toggle its mode between **Auto** and **Man** (manual). If set to **Auto**, the resolution bandwidth is set to **Span/50** (2% of the span). If set to **Man**, you can enter a value ranging from 100.0 mHz to 3.00000 MHz. A narrower bandwidth will result in a longer data acquisition time.
- **Average**
  - **Avg Number** - Changes the number of N averages.
  - **Avg Mode** - Toggles the averaging mode between **Exp** (exponential) and **Repeat**. This selection only effects on the averaging result after the number of N averages is reached. The N is set using the **Avg Number** key.
    - **Normal averaging:** Normal (linear) averaging is always used until the specified number of N averages is reached. When the **Measure** key under **Meas Control** is set to **Single**, data acquisition is stopped when the number of N averages is reached, thus **Avg Mode** has no effect in the single measurement mode.
    - **Exponential averaging:** When **Measure** is set to **Cont**, data acquisition will continue indefinitely. Exponential averaging is used with a weighting factor of N (the displayed count of averages stops at N). Exponential averaging weights new data more heavily than old data, which allows tracking of slow-changing signals. The weighting factor N is set using the Avg Number key.
    - **Repeat averaging:** When **Measure** is set to **Cont**, data acquisition will continue indefinitely. After the number of N averages is reached, all previous result data is cleared and the average count displayed is set back to 1. This is equivalent to being in **Measure Single** and pressing the **Restart** key each time

the single measurement finishes.

- **Avg Type** - Accesses the menu of the following average types only for making spectrum (frequency domain) and waveform (time domain) measurements:
  - ❑ **Pwr Avg (RMS)** - Executes the true power averaging which is calculated by averaging the rms voltage. This is the most accurate type.
  - ❑ **Log-Pwr Avg (Video)** - Simulates the traditional spectrum analyzer type of averaging by calculating the log of the power. This type of averaging will underestimate the power when the signal is noise-like.
  - ❑ **Voltage Avg** - Executes voltage averaging.
  - ❑ **Maximum** - Captures peak voltage data. Simulates the traditional spectrum analyzer peak hold function.
  - ❑ **Minimum** - Captures the minimum voltage data, similar to the maximum function.

- **Trig Source**

Key path: **Meas Setup, Trig Source**

---

**NOTE**

---

Changing the selection in the **Trig Source** menu alters the trigger source for the selected measurement only.

- **Free Run (Immediate)** - A trigger occurs at the time the data is requested, completely asynchronous with the RF or IF signal.
- **Video (Envlp)** - An internal IF envelope trigger that occurs at the absolute threshold level of the IF signal level.
- **RF Burst (Wideband)** - An internal wideband RF burst trigger that has the automatic level control for burst signals. It triggers at the level that is set relative to the peak RF signal (12 MHz bandwidth) input level.
- **Ext Front** - Activates the front panel external trigger input (**EXT TRIGGER INPUT**) port. The external signal must be between  $-5.00$  and  $+5.00$  V with 1 or 10 mV resolution.
- **Ext Rear** - Activates the rear-panel external trigger input (**TRIGGER IN**) port. The external signal must be between  $-5.00$  and  $+5.00$  V with 1 or 10 mV resolution.
- **Frame** - Uses the internal frame clock to generate a trigger signal. The clock parameters are controlled under the **Mode Setup** key or the measurement firmware, but not both. Refer to the specific measurement section for details.
- **Line** - Sets the trigger to the internal line mode. Sweep triggers

occur at intervals synchronous to the line frequency. See the specific measurement section for details.

- **Restore Meas Defaults** - Presets only the settings that are specific to the selected measurement by pressing **Meas Setup, More (1 of 2), Restore Meas Defaults**. This will set the measure setup parameters, for the currently selected measurement only, to the factory defaults.
- **(Narrowband) Advanced** - Accesses the menu to change the following parameters.

**NOTE**

The advanced features should be used only if you are familiar with their operation. Changes from the default values may result in invalid data.

The **Narrowband** key word is only present if you have both Option B7J and 122 installed. Parameters that are under the **(Narrowband) Advanced** key only affect the standard narrow band IF path. The Option 122 wideband IF advanced functions are found under the **Wideband Advanced** key.

- **Pre-ADC BPF** - Toggles the pre-ADC bandpass filter function between **On** and **Off**. The pre-ADC bandpass filter is useful for rejecting nearby signals, so that sensitivity within the span range can be improved by increasing the ADC range gain.
- **Pre-FFT Filtr** - Toggles the pre-FFT filter between **Flat** (flat top) and **Gaussian**. The pre-FFT filter defaults to a flat top filter which has better amplitude accuracy. The Gaussian filter has better pulse response.
- **Pre-FFT BW** - Toggles the pre-FFT bandwidth function between **Auto** and **Man** (manual). The pre-FFT bandwidth filter can be set between 1 Hz and 10 MHz. If set to **Auto**, this pre-FFT bandwidth is nominally 50% wider than the span. This bandwidth determines the ADC sampling rate.
- **FFT Window** - Accesses the following selection menu. Unless you are familiar with FFT windows, use the flat top filter (the default filter).
  - Flat Top** - Selects this filter for best amplitude accuracy by reducing scalloping error.
  - Uniform** - Select this filter to have no window active by using the uniform setting.
  - Hanning** - Press this key to activate the Hanning filter.
  - Hamming** - Press this key to activate the Hamming filter.
  - Gaussian** - Press this key to activate the Gaussian filter with the roll-off factor (alpha) of 3.5.
  - Blackman** - Press this key to activate the Blackman filter.



- Blackman Harris** - Press this key to activate the Blackman Harris filter.
- K-B 70dB/90dB/110dB (Kaiser-Bessel)** - Select one of the Kaiser-Bessel filters with sidelobes at -70, -90, or -110 dBc.
- **FFT Size** - Accesses the menu to change the following parameters:
  - Length Ctrl** - Toggles the FFT and window length setting function between **Auto** and **Man** (manual).
  - Min Pts in RBW** - Sets the minimum number of data points that will be used inside the resolution bandwidth. The range is 0.10 to 100.00 points with 0.01 resolution. This key is grayed out if **Length Ctrl** is set to **Man**.
  - Window Length** - Enters the FFT window length in the number of capture samples, ranging from 8 to 1048576. This length represents the actual quantity of I/Q samples that are captured for processing by the FFT (“Capture Time” is the associated parameter shown on the screen). This key is grayed out if **Length Control** is set to **Auto**.
  - FFT Length** - Enters the FFT length in the number of captured samples, ranging from 8 to 1048576. The FFT length setting is automatically limited so that it is equal to or greater than the FFT window length setting. Any amount greater than the window length is implemented by zero-padding. This key is grayed out if **Length Control** is set to **Auto**.
- **ADC Range** - Accesses the menu to define one of the following ADC ranging functions:
  - Auto** - Sets the ADC range automatically. For most FFT spectrum measurements, the auto feature should not be selected. An exception is when measuring a signal which is “bursty”, in which case auto can maximize the time domain dynamic range, if FFT results are less important to you than time domain results.
  - Auto Peak** - Sets the ADC range automatically to the peak signal level. Auto peak is a compromise that works well for both CW and burst signals.
  - Auto Peak Lock** - Select this to hold the ADC range automatically at the peak signal level. Auto peak lock is more stable than auto peak for CW signals, but should not be used for “bursty” signals.
  - Manual** - Accesses the selection menu of values, -6 to +24 dB for E4406A or None to +18 dB for PSA, to set the ADC range level. Also note that manual ranging is best for CW signals.
- **Data Packing** - Selects **Auto** (the default) or the **Short (16 bit)**, **Medium (24 bit)** and **Long (32 bit)** methods of data packing. The

short, medium, and long methods are not compatible with all settings and should not be used unless you are familiar with data packing methods. **Auto** is the preferred choice.

- Auto** - The data packing value most appropriate for current instrument settings is selected automatically.
  - Short (16 bit)** - Select this to pack data every 16 bits.
  - Medium (24 bit)** - Select this to pack data every 24 bits.
  - Long (32 bit)** - Select this to pack data every 32 bits.
- **ADC Dither** - Toggles the ADC dither function between **Auto**, **On**, and **Off**. When set to **Auto** (the default), the ADC dither function will be activated when a narrow bandwidth is being measured, and deactivated when a wide bandwidth is being measured. “ADC dither” refers to the introduction of noise to the digitized steps of the analog-to-digital converter; the result is an improvement in amplitude accuracy. Use of the ADC dither, however, reduces dynamic range by approximately 3 dB.
- **Decimation** - Toggles the decimation function between **Auto** and **Man**, and to set the decimation value. **Auto** is the preferred setting, and the only setting that guarantees alias-free FFT spectrum measurements. If you are familiar with the decimation feature, you can change the decimation value by setting to **Man**, but be aware that aliasing can result in higher values. Decimation numbers 1 to 1000 describe the factor by which the number of points are reduced. The default setting is 0, which results in no data point reduction. Decimation by 3 keeps every 3rd sample, throwing away the 2 in between.
- **IF Flatness** - Toggles the IF flatness function between **On** and **Off**. If set to **On** (the default), the IF flatness feature causes background amplitude corrections to be performed on the FFT spectrum. The **Off** setting is used for adjustment and troubleshooting of the test instrument.

The following table shows the factory default settings for spectrum (frequency domain) measurements.

Table 3-13

**Spectrum (Frequency Domain) Measurement Defaults**

Measurement Parameter	Factory Default Condition
Trace Display	All
Res BW	20.0000 kHz; Auto

**Table 3-13 Spectrum (Frequency Domain) Measurement Defaults**

Measurement Parameter	Factory Default Condition
Averaging: Avg Number Avg Mode Avg Type Time Avg Num (Option 122)  Trig Source  IF Path (requires both Options B7J and 122)  Wideband IF Gain (Options 122)  Wideband Filtering (Options 122) Filter Type Filter Alpha Filter BW  <b>Spectrum View:</b> SPAN AMPLITUDE Y Scale - Scale/Div  <b>I/Q Waveform View:</b> Capture Time AMPLITUDE Y Scale - Scale/Div	25; On Exp Log-Pwr Avg (Video) 1  RF Burst (Wideband)  Narrow  0.00 dB  None 0.30 0.50  1.00000 MHz 10.00 dB  188.00 $\mu$ s 100.0 mV
<b>(Narrowband) Advanced</b>	
Pre-ADC BPF Pre-FFT Filter Pre-FFT BW FFT Window FFT Size: Length Control Min Points/RBW Window Length FFT Length ADC Range Data Packing ADC Dither Decimation IF Flatness	On Flat 1.55000 MHz; Auto Flat Top (High Amptd Acc) Auto 3.100000 706 1024 Auto Peak Auto Auto 0; Auto On
<b>Wideband Advanced</b> (Option 122)	
ADC Correction	On

Table 3-13

**Spectrum (Frequency Domain) Measurement Defaults**

Measurement Parameter	Factory Default Condition
IF Flatness Corrections	On
Analog Filter	Auto, 80 MHz
WB ADC Dither	On
FFT Window	Flat Top (High Amptd Acc)
FFT Size:	
Length Control	Auto
Min Points/RBW	3.100
Window Length	566
FFT Length	1024

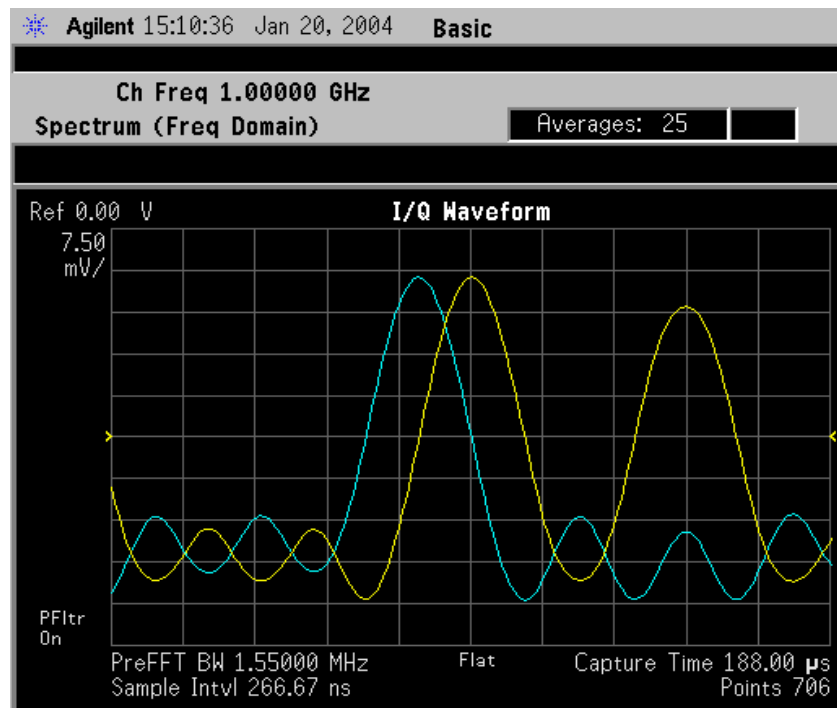
**View/Trace Key Menu**

The View/Trace key allows you to select the desired view of the measurement from the following. You can use the Next Window key to move between the multiple windows (if any) and make it full size by Zoom.

- **Spectrum** - Provides a combination view of the spectrum graph in parameters of power versus frequency with semi-log graticules, and the I/Q waveform graph in parameters of voltage and time. Changes to frequency span or power will sometimes affect data acquisition. This is equivalent to changing the selected window with the **Next** key.

- **Spectrum (Time Domain) I/Q Waveform** - (Key for PSA only) This graph is shown below the **Spectrum** graph in the default dual-window display. **I/Q Waveform** provides a view of the I/Q waveform in parameters of voltage versus time in linear scale. Changes to sweep time or resolution bandwidth can affect data acquisition. Pressing this button is equivalent to pressing the **Next Window** and **Zoom** buttons on the front panel.

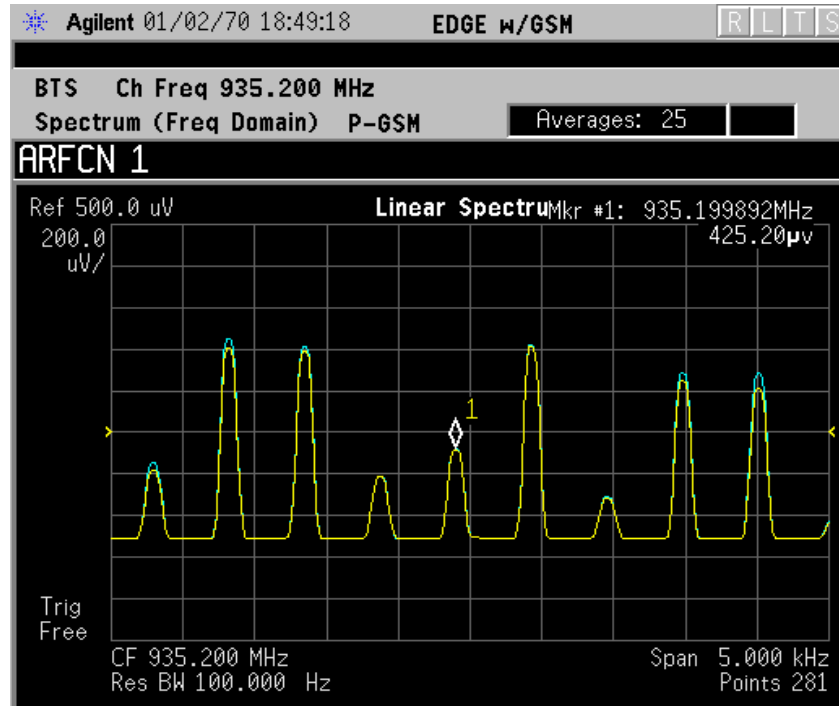
**Figure 3-27 Spectrum Measurement - I/Q Waveform (Time Domain) Result (E4406A View)**



Key Reference  
Measurement Keys

- **Spectrum Linear** - (for E4406A) Provides a view of the spectrum graph in parameters of voltage versus frequency in linear scale. Changes to frequency span or voltage can affect data acquisition.

**Figure 3-28 Spectrum Measurement - Linear Spectrum View (for E4406A)**



\*Meas Setup: View/Trace = Spectrum Linear,  
Span = 5.000 kHz,  
Y Scale/Div = 200  $\mu$ V, Ref Value = 500.0  $\mu$ V,  
Others = Factory default settings

\*Input signals: -20.00 dBm, EDGE pattern data (PN9)

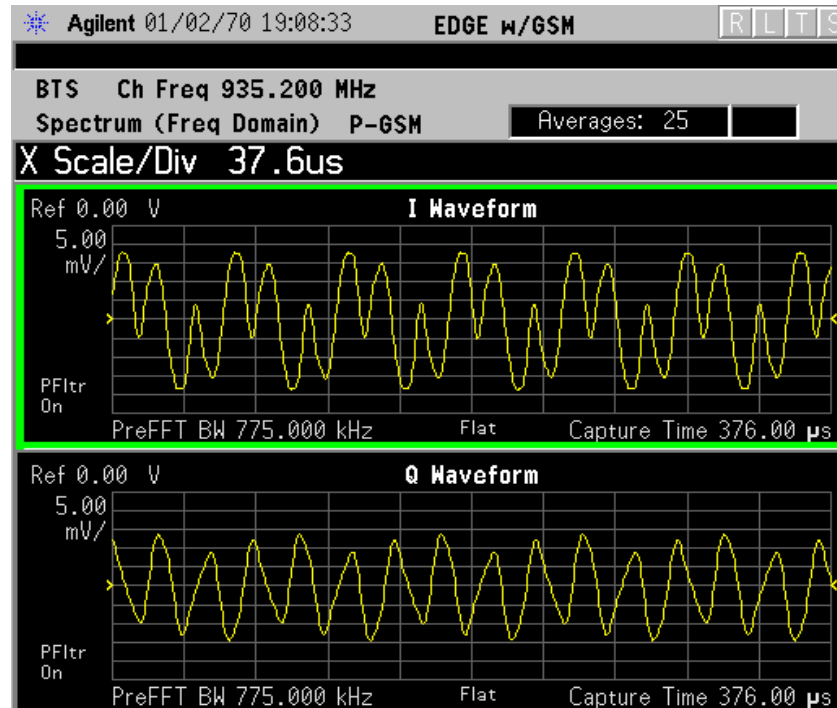
**NOTE**

(for E4406A) For the widest spans, the I/Q window becomes just “ADC time domain samples”, because the I/Q down-conversion is no longer in effect. This is not the case for E4406A Option B7C if the **Input Port** is set to either **I/Q**, **I only**, or **Q only** and you have connected baseband I/Q signals to the **I/Q INPUT** connectors.

- **I and Q Waveform** - (for E4406A) Provides individual views of the I and Q signal waveform windows in parameters of voltage versus time.

To select the I or Q trace view, press the **Next** key at the bottom of the display. The selected window will have a green outline. To view the window full size press the **Zoom** key.

**Figure 3-29 Spectrum Measurement - I and Q Waveform View (for E4406A)**



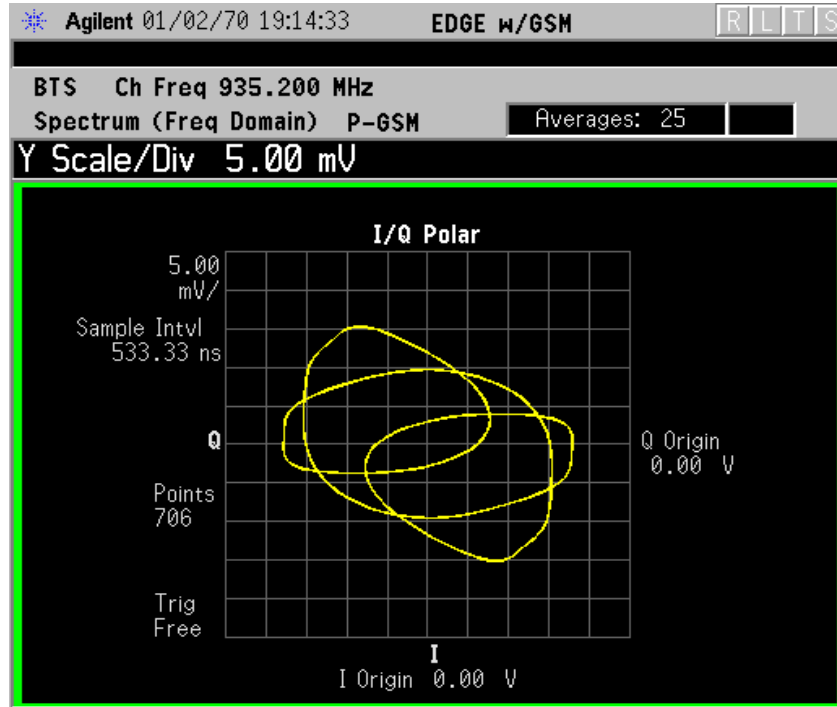
\*Meas Setup: View/Trace = I and Q Waveform  
Span = 500.000 kHz,  
Y Scale/Div = 5.0 mV, Ref Value = 0.0 V,  
Others = Factory default settings

\*Input signals: -20.00 dBm, EDGE pattern data (PN9)

Key Reference  
Measurement Keys

- **I/Q Polar** - (for E4406A) Provides a view of the I/Q signal displayed in a polar vector graph.

**Figure 3-30 Spectrum Measurement - I/Q Polar View (for E4406A)**



\*Meas Setup: View/Trace = I/Q Polar  
Span = 500.000 kHz,  
Y Scale/Div = 5.0 mV, Ref Value = 0.0 V,  
Others = Factory default settings

\*Input signals: -20.00 dBm, EDGE pattern data (PN9)

- **Trace Display** - Press this key to reveal the trace selection menu. The currently selected trace type is shown on the **Trace Display** key.
  - **All** - Views both the current trace and the average trace.
  - **Average** - Views only the average trace (in blue color). See the **Meas Setup**, **Average** keys to select different types of averaging.
  - **Current** - Views only the trace (in yellow color) for the latest data acquisition.
  - **I Trace** - (for E4406A) Views only the I signal trace.
  - **Q Trace** - (for E4406A) Views only the Q signal trace.



## SPAN X Scale Key Menu

---

**NOTE**

The **Spectrumor Linear Spectrum** (for E4406A) window must be active in the **Spectrumor Spectrum Linear** (for E4406A) view to access the following **Span X Scale** key menu:

---

- **Span** - Modifies the frequency span. The range is 10.000 Hz to 10.000 MHz with 1 Hz resolution, depending on the **Res BW** setting. Changing the span causes the resolution bandwidth to change automatically, and will affect data acquisition time. The **Span** key is also accessible under the **Meas Setup** menu.

---

**NOTE**

The **I/Q Waveform** (for E4406A) window must be active in the **Spectrum** or **Spectrum Linear** (for E4406A) view to access the following **Span X Scale** key menu:

---

- **Scale/Div** - Sets the horizontal scale by changing a time value per division. The range is 1.00 ns to 1.00 s per division. The default setting is 18.8 ms per division. However, since the **Scale Coupling** default is **On**, this value is automatically determined by the measurement results. When you set a value manually, **Scale Coupling** automatically changes to **Off**.
- **Ref Value** - Sets the reference value ranging from -1.00 to 10.0 s. The default setting is 0.00 s. However, since the **Scale Coupling** default is **On**, this value is automatically determined by the measurement results. When you set a value manually, **Scale Coupling** automatically changes to **Off**.
- **Ref Position** - Sets the reference position to either **Left**, **Ctr** (center) or **Right**. The default setting is **Left**.
- **Scale Coupling** - Toggls the scale coupling function between **On** and **Off**. The default setting is **On**. Upon pressing the **Restart** front-panel key or **Restart** softkey under the **Meas Control** menu, this function automatically determines the scale per division and reference values based on the measurement results. When you set a value to either **Scale/Div** or **Ref Value** manually, **Scale Coupling** automatically changes to **Off**.

---

**NOTE**

The **I/Q Polar** window must be active in the **I/Q Polar** view (for E4406A), for the **SPAN X Scale** key to access the following menu:

---

- **I/Q Scale/Div** - Sets the vertical and horizontal scales by changing the value per division. The range is 1.00 nV to 20.00 V per division. The default setting is 100.0 mV.
- **I Origin** or **Q Origin** - Sets the reference value ranging from -250.00 to 250.00 V. The default setting is 0.00 V.

## AMPLITUDE Y Scale Key Menu

---

### NOTE

The **Spectrumor Linear Spectrum** (for E4406A) window must be active in the **Spectrumor Spectrum Linear** (for E4406A) view to access the following **AMPLITUDE Y Scale** key menu:

---

- **Scale/Div** - Sets the vertical scale by changing an amplitude value per division. The range is 0.10 dB to 20.00 dB per division. The default setting is 10.00 dB. However, since the **Scale Coupling** default is **On**, this value is automatically determined by the measurement results. When you set a value manually, **Scale Coupling** automatically changes to **Off**.
- **Ref Value** - Sets the reference value ranging from -250.00 to 250.00 dBm. The default setting is 0.00 dBm. However, since the **Scale Coupling** default is **On**, this value is automatically determined by the measurement results. When you set a value manually, **Scale Coupling** automatically changes to **Off**.
- **Ref Position** - Sets the reference position to either **Top**, **Ctr** (center) or **Bot** (bottom). The default setting is **Ctr**.
- **Scale Coupling** - Toggles the scale coupling function between **On** and **Off**. The default setting is **On**. Upon pressing the **Restart** front-panel key or **Restart** softkey under the **Meas Control** menu, this function automatically determines the scale per division and reference values based on the measurement results. When you set a value to either **Scale/Div** or **Ref Value** manually, **Scale Coupling** automatically changes to **Off**.

---

### NOTE

The **I or Q Waveform** window must be active in the **I and Q Waveform** view (**for E4406A**) for the **AMPLITUDE Y Scale** key to access the following menu:

---

- **Scale/Div** - Sets the vertical scale by changing the amplitude value per division. The range is 1.00 nV to 20.00 V per division. The default setting is 100.0 mV. However, since the **Scale Coupling** default is **On**, this value is automatically determined by the measurement results. When you set a value manually, **Scale Coupling** automatically changes to **Off**.
- **Ref Value** - Sets the reference value ranging from -250.00 to 250.00 V. The default setting is 0.00 V. However, since the **Scale Coupling** default is **On**, this value is automatically determined by the measurement results. When you set a value manually, **Scale Coupling** automatically changes to **Off**.
- **Ref Position** - Sets the reference position to either **Top**, **Ctr** (center) or **Bot** (bottom). The default setting is **Ctr**.
- **Scale Coupling** - Toggles the scale coupling function between **On** and **Off**.

**Off.** The default setting is **On**. The **Restart** front-panel key or **Restart** softkey under the **Meas Control** menu, this function automatically determines the scale per division and reference values by the measurement results. When you set a value to either **Scale/Div** or **Ref Value** manually, **Scale Coupling** automatically changes to **Off**.

---

**NOTE**

---

The I/Q Polar window must be active in the **I/Q Polar** view (for E4406A), for the **AMPLITUDE Y Scale** key to access the following menu:

- **I/Q Scale/Div** - Sets the vertical and horizontal scales by changing the value per division. The range is 1.00 nV to 20.00 V per division. The default setting is 100.0 mV.
- **I Origin** or **Q Origin** - Sets the reference value ranging from -250.00 to 250.00 V. The default setting is 0.00 V.

### Display Key Menu

The Display Key is not active for this measurement.

### Marker Key Menu

- **Select 1 2 3 4** - Activates up to four markers with the corresponding numbers, respectively. The selected number is underlined and its function is defined by pressing the **Function** key. The default is 1.
- **Normal** - Activates the selected marker to read the frequency and amplitude of the marker position on the spectrum trace. Marker position is controlled by the **RPG** knob.
- **Delta** - Reads the differences in frequency and amplitude between the selected marker and the next marker.
- **Function Off** - Selects marker function to be **Band Power**, **Noise**, or **Off**. The default is **Off**. If set to **Band Power**, you need to select **Delta**.
- **Trace Spectrum** - Places the selected marker on the **Spectrum**, **Spectrum Avg**, **Spectrum Linear** (for E4406A), **Spectrum Avg Linear** (for E4406A), **I Waveform** (for E4406A), or **Q Waveform** (for E4406A) or **I/Q Waveform** trace. The default is **Spectrum**.
- **Off** - Turns off the selected marker.
- **Shape Diamond** - Accesses the menu to define the selected marker shape to be **Diamond**, **Line**, **Square**, or **Cross**. The default shape is **Diamond**.
- **Marker All Off** - Turns off all of the markers.

### Peak Search Key

The front panel **Search** key performs a peak search when pressed. A marker will automatically be activated at the highest peak.

## Transmit Power Measurement Keys

---

**NOTE** Make sure the Transmit Power measurement is selected under the **Measure** menu.

---

### Measurement Setup Key Menu

Key Path: **Meas Setup**

- **Averages, Avg Bursts On Off** and **Avg Number** - Allow you to change the number of N averages that are made. **Avg Number** - Also allows you to select whether averages are made or not.
- **Avg Mode Exp Repeat** - Allows you to choose either exponential or repeat averaging. This selection only effects the averaging after the number of N averages is reached (set using the **Averages, Avg Bursts, or Avg Number** key).
  - **Normal averaging:** Normal (linear) averaging is always used until the specified number of N averages is reached. When **Measure** is set at **Single**, data acquisitions are stopped when the number of averages is reached - thus **Avg Mode** has no effect on single measurements.
  - **Exponential averaging:** When **Measure** is set at **Cont**, data acquisitions will continue indefinitely. After N averages, exponential averaging is used with a weighting factor of N (the displayed average count stops at N). Exponential averaging weights new data more than old data, which allows tracking of slow-changing signals. The weighting factor N is set using the **Averages, Avg Bursts, or Avg Number** key.
  - **Repeat averaging:** When **Measure** is set at **Cont**, data acquisitions will continue indefinitely. After N averages is reached, all previous result data is cleared and the average count is set back to 1. This is equivalent to being in **Measure Single** and pressing the **Restart** key when the Single measurement finishes.
- **Avg Type** - Select the averaging type from the following selections: (Not all of the selections are available for all measurements)
  - Pwr Avg (RMS)** - True power averaging that is equivalent to taking the RMS value of the voltage. It is the most accurate type of averaging.
  - Log-Pwr Avg (Video)** - Simulates the traditional spectrum analyzer type of averaging by averaging the log of the power.
  - Mean** - Averages the mean values.
  - Voltage Avg** - Averages the voltage values.
  - Maximum** - Keeps track of the maximum values.

**Minimum** - Keeps track of the minimum values.

**Max & Min** - Keeps track of the maximum and minimum values.

- **Meas Time** - allows you to measure more than one timeslot. Enter a value in integer increments of “slots” with a range of 1 to 8. The actual measure time in  $\mu\text{s}$  is set somewhat longer than the specified number of slots in order to view the complete burst.
- **Trig Source Key Menu**

Changing the selection in the **Trig Source** menu alters the trigger source for the selected measurement only. Not all of the selections are available for all measurements. Note that the **RF Burst (Wideband)**, **Video (IF Envlp)**, **Ext Front**, and **Ext Rear** menu keys found in the **Trigger** menu enable you to change settings to modify the delay, level, and slope for each of these trigger sources. Choose one of the following sources:

- **Free Run (Immediate)** - The trigger occurs at the time the data is requested, completely asynchronous to the RF or IF signal.
- **RF Burst (Wideband)** - An internal wideband RF burst trigger that has an automatic level control for burst signals. It triggers on a level that is relative to the peak of the signal passed by the RF. If the data sent is all 0 bits, this trigger will give erratic or falsely high EVM results.
- **Video (IF Envlp)** - An internal IF envelope trigger. It triggers on an absolute threshold level of the signal passed by the IF.
- **Ext Front** - Activates the front panel external trigger input (**EXT TRIGGER INPUT**). The external trigger must be a signal between  $-5$  and  $+5$  volts.
- **Ext Rear** - Activates the rear panel external trigger input (**TRIGGER IN**). The external trigger must be a signal between  $-5$  and  $+5$  volts.
- **Frame** - Uses the internal frame clock to generate a trigger signal. The clock parameters are controlled under the **Mode Setup** key or the measurement firmware, but not both. See the specific measurement for details.
- **Line** - activates an internal line trigger. Sweep triggers occur at intervals synchronized to the line frequency.

Rear panel **TRIGGER 1 OUT** and **TRIGGER 2 OUT** connectors are coupled to the selected trigger source. These trigger outputs are always on the rising edge with a pulse width of at least  $1 \mu\text{s}$ .

- **Burst Sync**

Pressing the **Burst Sync** key allows you to choose the source used to synchronize the measurement to the “T0” point of the GSM or EDGE

burst. The “T0” point is defined as the time point of the transition from bit 13 to bit 14 of the midamble training sequence for a given time slot. The **Burst Search Threshold** setting (in the **Mode Setup** keys under **Trigger**) applies to both **Training Seq** and **RF Amptd**. Pressing the **Burst Sync** key will bring up a menu with some or all of the following choices:

- **Training Seq** - Synchronizes the measurement to the timing of the demodulated training sequence in the GSM burst. This is the most precise method, but requires a GMSK or EDGE burst with a valid TSC (Training Sequence Code). The “T0” point is determined by demodulation of the burst and successful identification of the TSC. “T0” is then found to within 1/10 bit.
- **RF Amptd** - Synchronizes the measurement to the burst transition of the measured RF carrier. “T0” is set to the 50% point between the start and end of the burst.
- **None** - Use the start of the time record as the start of the useful part. “T0” is set to the middle of the useful part.
- **Ext** - Use the external trigger plus delay as the start of the useful part. “T0” is set to the middle of the useful part.

- **Advanced**

---

**NOTE**

Parameters that are under the Advanced key seldom need to be changed. Any changes from the factory default values may result in invalid measurement data.

---

- Accesses a menu to change the following parameters:

**RBW Filter** - this key toggles to select a Flat Top or a Gaussian (the default filter) resolution bandwidth filter. A Gaussian filter minimizes distortion products in the time domain, particularly for bursts. A Flat Top filter provides a flatter bandwidth but is less accurate for pulse responses. A Flat Top filter also requires less memory and allows longer data acquisition times.

**Res BW** - sets the resolution bandwidth.

**Table 3-14**
**Transmit Power Measurement Defaults**

Measurement Parameter	Factory Default Condition
Averages	50 On
Avg Mode	Exp
Avg Type	Pwr Avg (RMS)
Threshold Lvl	-6.00 dB Rel (to peak)
Trig Source	RF Burst (Wideband)

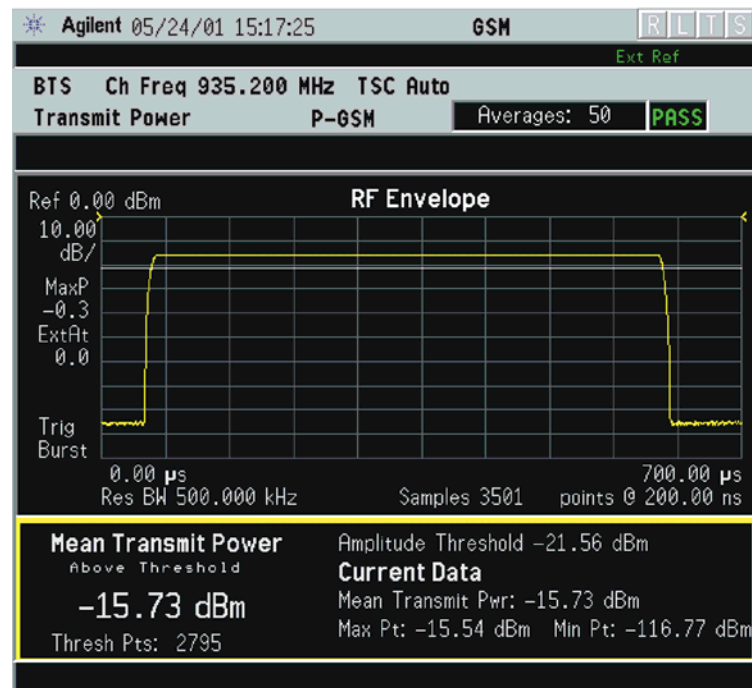
**Table 3-14** **Transmit Power Measurement Defaults**

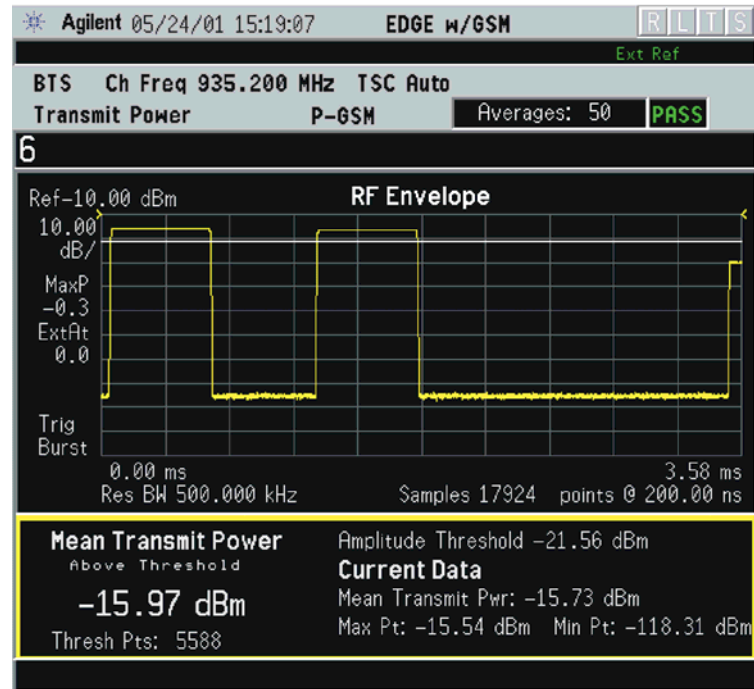
Measurement Parameter	Factory Default Condition
Burst Sync	None
Meas Time	1 slot
<b>Advanced</b>	
RBW Filter	Gaussian
Res BW	500.000 kHz

**Measurement Results**

Both the averaged and instantaneous results for Mean Transmit Power are displayed on the screen of the instrument. The Averaged Mean Transmit Power Above Threshold is displayed on the left of the display, while the value of the Mean Transmit Power Above Threshold for the current acquisition is displayed on the right of the screen under the heading Current Data Mean Transmit Pwr. If averaging is turned off, the two values can be the same. When you set averaging ON, the Mean Transmit Power Above Threshold is an averaged value.

**Figure 3-31** **Transmit Power Result - Single Burst (with data table)**



**Figure 3-32** Transmit Power Result - Multiple Bursts



## Waveform (Time Domain) Keys

---

**NOTE**

---

You must have selected **Waveform** under the Key Path: **MEASURE** menu to access these menus.

### Measurement Setup Key Menu

Key Path: **Meas Setup**

- **Sweep Time** - Specifies the measurement acquisition time which is used as the length of the time capture record. The range is 1.0  $\mu$ s and 100.0 s, depending upon the resolution bandwidth setting and the available internal memory size for acquisition points.
- **Res BW** - Sets the measurement bandwidth. The range is 10 Hz to 8 MHz using the Gaussian filter selected from RBW Filter under the Advanced menu, or 10 Hz to 10 MHz using the Flat top filter selected from RBW Filter. A larger bandwidth results in a larger number of acquisition points and reduces the maximum value allowed for the sweep time.
- **Average**
  - **Avg Number** - Changes the number of N averages.
  - **Avg Mode** - Toggles the averaging mode between **Exp** (exponential) and **Repeat**. This selection only effects on the averaging result after the number of N averages is reached. The N is set using the **Avg Number** key.
    - **Normal averaging**: Normal (linear) averaging is always used until the specified number of N averages is reached. When the **Measure** key under **Meas Control** is set to **Single**, data acquisition is stopped when the number of N averages is reached, thus **Avg Mode** has no effect in the single measurement mode.
    - **Exponential averaging**: When **Measure** is set to **Cont**, data acquisition will continue indefinitely. Exponential averaging is used with a weighting factor of N (the displayed count of averages stops at N). Exponential averaging weights new data more heavily than old data, which allows tracking of slow-changing signals. The weighting factor N is set using the Avg Number key.
    - **Repeat averaging**: When **Measure** is set to **Cont**, data acquisition will continue indefinitely. After the number of N averages is reached, all previous result data is cleared and the average count displayed is set back to 1. This is equivalent to being in **Measure Single** and pressing the **Restart** key each time the single measurement finishes.

- **Avg Type** - Accesses the menu of the following average types only for making spectrum (frequency domain) and waveform (time domain) measurements:
  - ❑ **Pwr Avg (RMS)** - Executes the true power averaging which is calculated by averaging the rms voltage. This is the most accurate type.
  - ❑ **Log-Pwr Avg (Video)** - Simulates the traditional spectrum analyzer type of averaging by calculating the log of the power. This type of averaging will underestimate the power when the signal is noise-like.
  - ❑ **Voltage Avg** - Executes voltage averaging.
  - ❑ **Maximum** - Captures peak voltage data. Simulates the traditional spectrum analyzer peak hold function.
  - ❑ **Minimum** - Captures the minimum voltage data, similar to the maximum function.

- **Trig Source**

Key path: **Meas Setup, Trig Source**

---

**NOTE**

---

Changing the selection in the **Trig Source** menu alters the trigger source for the selected measurement only.

- **Free Run (Immediate)** - A trigger occurs at the time the data is requested, completely asynchronous with the RF or IF signal.
- **Video (Envlp)** - An internal IF envelope trigger that occurs at the absolute threshold level of the IF signal level.
- **RF Burst (Wideband)** - An internal wideband RF burst trigger that has the automatic level control for burst signals. It triggers at the level that is set relative to the peak RF signal (12 MHz bandwidth) input level.
- **Ext Front** - Activates the front panel external trigger input (**EXT TRIGGER INPUT**) port. The external signal must be between  $-5.00$  and  $+5.00$  V with 1 or 10 mV resolution.
- **Ext Rear** - Activates the rear-panel external trigger input (**TRIGGER IN**) port. The external signal must be between  $-5.00$  and  $+5.00$  V with 1 or 10 mV resolution.
- **Frame** - Uses the internal frame clock to generate a trigger signal. The clock parameters are controlled under the **Mode Setup** key or the measurement firmware, but not both. Refer to the specific measurement section for details.
- **Line** - Sets the trigger to the internal line mode. Sweep triggers occur at intervals synchronous to the line frequency. See the specific measurement section for details.

- **Restore Meas Defaults** - Presets only the settings that are specific to the selected measurement by pressing **Meas Setup, More (1 of 2), Restore Meas Defaults**. This will set the measure setup parameters, for the currently selected measurement only, to the factory defaults.
- **(Narrowband) Advanced** Accesses the menu to change the following parameters.

---

**NOTE**

---

The advanced features should be used only if you are familiar with their operation. Changes from the default values may result in invalid data.

The **Narrowband** key label word is only present if you have both Option B7J and 122 installed. Parameters that are under the **(Narrowband) Advanced** key only affect the standard narrow band IF path. The Option 122 wideband IF advanced functions are found under the **Wideband Advanced** key.

- **Pre-ADC BPF** - Toggles the pre-ADC bandpass filter function between **On** or **Off**. The default setting is **Off**. The pre-ADC bandpass filter is useful for rejecting nearby signals, so that sensitivity within the span range can be improved by increasing the ADC range gain.
- **RBW Filter** - Toggles the resolution bandwidth filter selection between **Flat** and **Gaussian**. If set to **Gaussian**, the filter provides more even time-domain response, particularly for “bursts”. If set to **Flat**, the filter provides a flatter bandwidth but is less accurate for “pulse responses”. A flat top filter also requires less memory and allows longer data acquisition times. For most waveform applications, the Gaussian filter is recommended. The resolution bandwidth range is 10 Hz to 8 MHz using the Gaussian filter or 10 Hz to 10 MHz using the Flat top filter.
- **ADC Range** - Accesses the menu to select one of the ADC ranging functions:
  - Auto** - Automatically adjusts the signal range for optimal measurement results.
  - AutoPeak** - Continuously searches for the highest peak signal.
  - AutoPeakLock** - Adjusts the range for the highest peak signal it identifies. It retains the range settings determined by that peak signal, even when the peak signal is no longer present.
  - Manual** - Accesses the selection menu of values, -6 to +24 dB for E4404A or None to +18 dB for PSA, to set the ADC range level. Also note that manual ranging is best for CW signals.
- **Data Packing** - Selects **Auto** (the default) or the **Short (16 bit)**, **Medium (24 bit)** and **Long (32 bit)** methods of data packing. The short, medium, and long methods are not compatible with all settings and should not be used unless you are familiar with data

packing methods. **Auto** is the preferred choice.

- Auto** - The data packing value most appropriate for current instrument settings is selected automatically.
  - Short (16 bit)** - Select this to pack data every 16 bits.
  - Medium (24 bit)** - Select this to pack data every 24 bits.
  - Long (32 bit)** - Select this to pack data every 32 bits.
- **ADC Dither** - Toggles the ADC dither function between **On** and **Off**. The default setting is **Off**. If set to **On**, the ADC dither refers to the introduction of noise to the digitized steps of the analog-to-digital converter, and results in better amplitude linearity and resolution in low level signals. However, it also results in reduced dynamic range by approximately 3 dB.
- **Decimation** - Toggles the decimation function between **On** and **Off**, and to set the decimation value. Decimation allows longer acquisition times for a given bandwidth by eliminating data points. Long time captures can be limited by the instrument data acquisition memory. Decimation numbers 1 to 4 describe the factor by which the number of points are reduced. The default setting is 1, which results in no data point reduction.

Table 3-15

Waveform (Time Domain) Measurement Defaults

Measurement Parameter	Factory Default Condition
Sweep Time	2.000 ms
Res BW	500.000 kHz
Averaging: Avg Number Avg Mode Avg Type	10; Off Exp Pwr Avg (RMS)
Trig Source	RF Burst
IF Path (requires both Options B7J and 122)	Narrow
Wideband IF Gain (Option 122)	0.00 dB
Wideband Filtering (Options 122) Filter Type Filter Alpha Filter BW	None 0.30 0.50
<b>Signal Envelope View</b> SPAN X Scale - Scale/Div AMPLITUDE Y Scale - Scale/Div	<b>(for E4406A)</b> 200.0 $\mu$ s 10.00 dB

**Table 3-15 Waveform (Time Domain) Measurement Defaults**

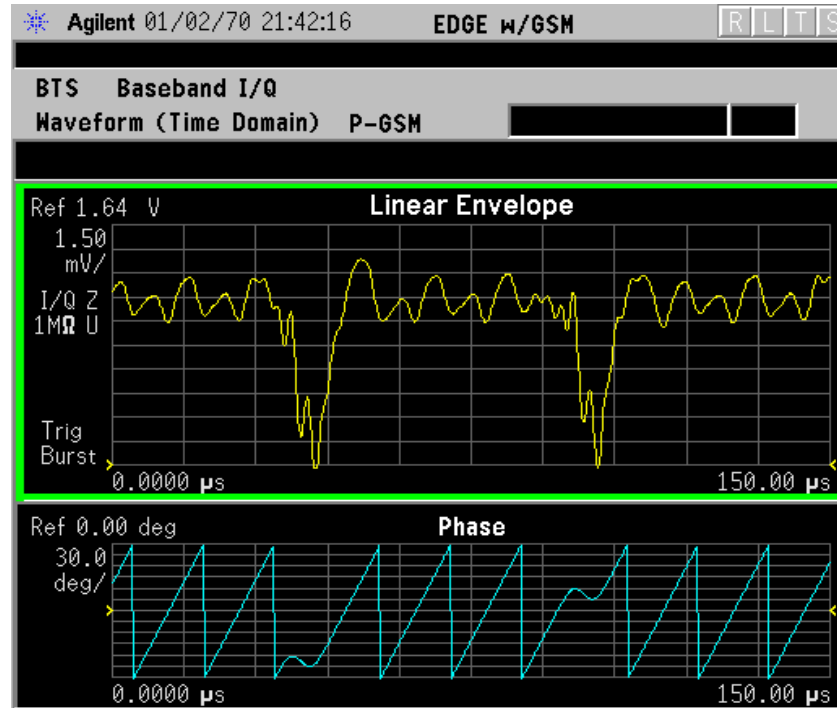
<b>Measurement Parameter</b>	<b>Factory Default Condition</b>
<b>RF Envelope View</b> SPAN X Scale - Scale/Div AMPLITUDE Y Scale - Scale/Div	<b>(for PSA)</b> 200.0 $\mu$ s 10.00 dB
<b>Linear Envelope View</b> SPAN X Scale - Scale/Div <b>Linear Envelope window:</b> AMPLITUDE Y Scale - Scale/Div <b>Phase window:</b> AMPLITUDE Y Scale - Scale/Div	<b>(for E4406A Option B7C)</b> 200.0 $\mu$ s 100.0 mV 30.0 deg
<b>I/Q Waveform View:</b> SPAN X Scale -Scale/Div AMPLITUDE Y Scale - Scale/Div	200.0 $\mu$ s 100.0 mV
<b>I and Q Waveform View:</b> SPAN X Scale -Scale/Div AMPLITUDE Y Scale - Scale/Div	<b>(for E4406A Option B7C)</b> 200.0 $\mu$ s 100.0 mV
<b>(Narrowband) Advanced</b>	
Pre-ADC BPF	Off
RBW Filter	Gaussian
ADC Range	Auto
Data Packing	Auto
ADC Dither	Off
Decimation	Off
<b>Wideband Advanced (Option 122)</b>	
ADC Correction	On
IF Flatness Corrections	On
Analog Filter	Auto, 80 MHz
WB ADC Dither	On
Trigger Interpolation	On

### View/Trace Key Menu

Key Path: View/Trace

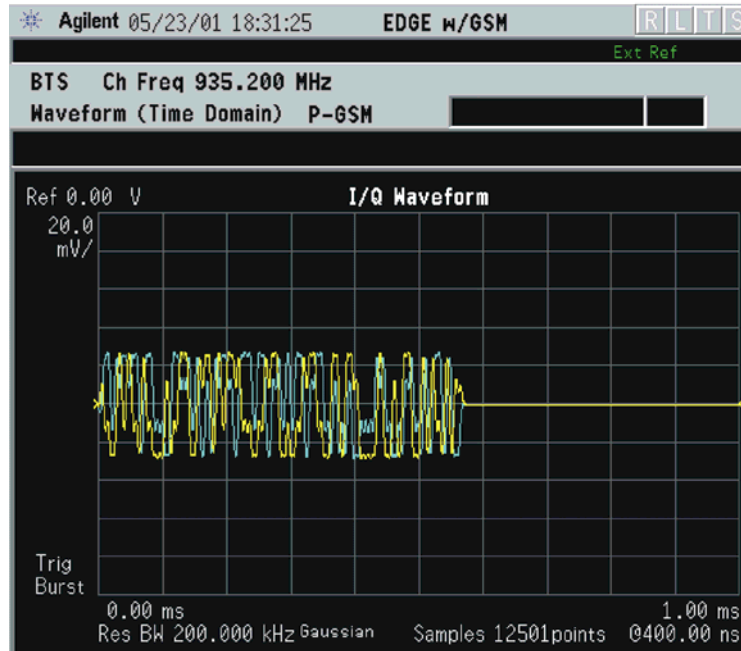
- **Linear Envelope** - (for E4406A Option B7C) Provides a combination view of a linear signal envelope graph and a phase graph with linear graticules. Use the **Next Window** and **Zoom** keys to select and enlarge either graph.

**Figure 3-33** Waveform Measurement - Linear Envelope View



- **I/Q Waveform** - Provides a view of the I and Q waveforms together on the same graph in parameters of voltage versus time in linear scale. Changes to sweep time or resolution bandwidth can affect data acquisition.

**Figure 3-34** Waveform Measurement - I/Q Waveform View

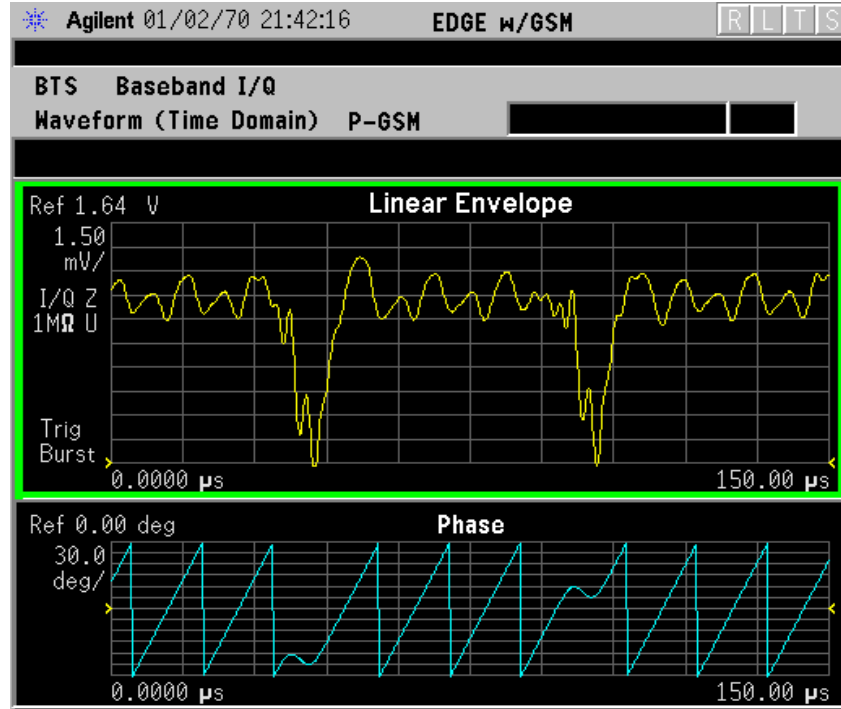


**NOTE**

For the widest spans the I/Q Waveform window becomes just “ADC time domain samples”, because the I/Q down-conversion is no longer in effect.

- **I and Q Waveform** - (for E4406A Option B7C) Provides a combination view of the I and Q signal waveform graphs in the linear scales.

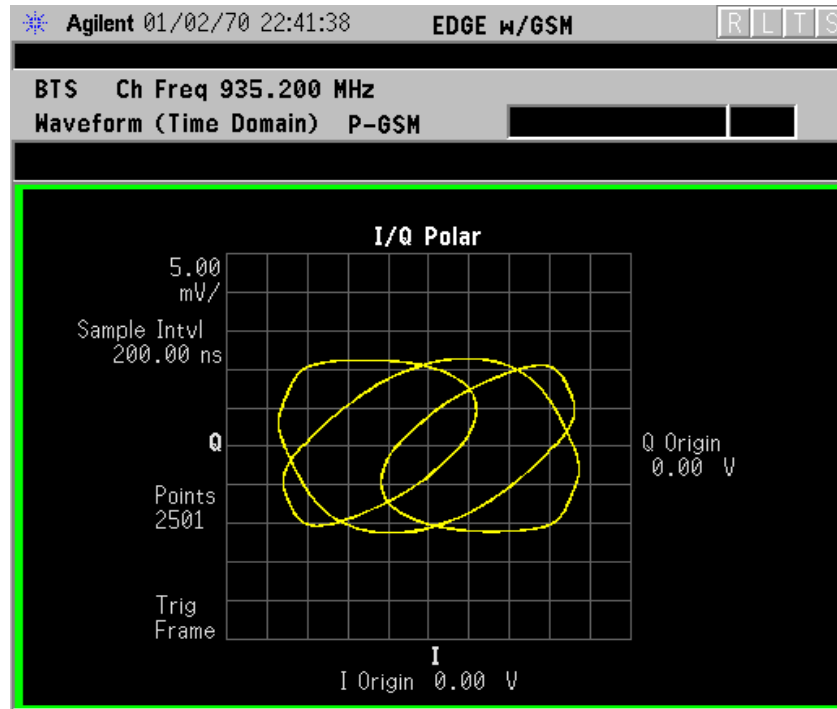
**Figure 3-35** Waveform Measurement - I and Q Waveform View





- **I/Q Polar** - (for E4406A) Provides a view of the I/Q signal in a polar vector graph.

**Figure 3-36** Waveform Measurement - I/Q Polar View



- **Trace Display** - Press this key to access the trace selection menu. The currently selected trace type is shown on the **Trace Display** key.
  - **All** - Views both the current trace and the average trace.
  - **Average** - Views only the average trace (in blue color). See the **Meas Setup**, **Average** keys to select different types of averaging.
  - **Current** - Views only the trace (in yellow color) for the latest data acquisition.
  - **I Trace** - (for E4406A) Views only the I signal trace.
  - **Q Trace** - (for E4406A) Views only the Q signal trace.

### SPAN X Scale Key Menu

Key Path: **Span X Scale**

**NOTE**

The **SPAN X Scale** key accesses the menu to modify the horizontal parameters common to the scaled windows for this measurement. Use the **Sweep Time** key under the **Meas Setup** menu to control the horizontal time span for this measurement:

- **Scale/Div** - Sets the horizontal scale by changing a time value per

Key Reference  
Measurement Keys

division. The range is 1.0 ns to 1.000 s per division with 0.01 ns resolution. The default setting is 200.0  $\mu$ s per division. However, since the **Scale Coupling** default is **On**, this value is automatically determined by the measurement result. When you set a value manually, **Scale Coupling** automatically changes to **Off**.

- **Ref Value** - Sets the reference value ranging from  $-1.0$  to  $10.0$  s. The default setting is  $0.00$  s. However, since the **Scale Coupling** default is **On**, this value is automatically determined by the measurement result. When you set a value manually, **Scale Coupling** automatically changes to **Off**.
- **Ref Position** - Sets the reference position to either **Left**, **Ctr** (center) or **Right**. The default setting is **Left**.
- **Scale Coupling** - Toggles the scale coupling function between **On** and **Off**. The default setting is **On**. Upon pressing the **Restart** front-panel key or **Restart** softkey under the **Meas Control** menu, this function automatically determines the scale per division and reference values based on the measurement results. When you set a value to either **Scale/Div** or **Ref Value** manually, **Scale Coupling** automatically changes to **Off**.

---

**NOTE**

For E4406A, if the I/Q Polar window is active in the I/Q Polar view, the **SPAN X Scale** key accesses the following menu:

- **I/Q Scale/Div** - Sets the vertical and horizontal scales by changing a value per division. The range is  $1.00$  nV to  $20.00$  V per division. The default setting is  $100.0$  mV.
- **I or Q Origin** - Sets the reference value ranging from  $-250.00$  to  $250.00$  V. The default setting is  $0.00$  V.

## AMPLITUDE Y Scale Key Menu

Key Path: **AMPLITUDE Y Scale**

---

**NOTE**

If the **RF Envelope** (for PSA) or **Signal Envelope** (for E4406A) window is active in the **RF Envelope** (for PSA) or **Signal Envelope** (for E4406A) view, the **AMPLITUDE Y Scale** key accesses the following menu:

- **Scale/Div** - Sets the vertical scale by changing an amplitude value per division. The range is 0.10 to 20.00 dB per division with 0.01 dB resolution. The default setting is 10.00 dB per division. However, since the **Scale Coupling** default is **On**, this value is automatically determined by the measurement result. When you set a value manually, **Scale Coupling** automatically changes to **Off**.
- **Ref Value** - Sets the reference value ranging from -250.00 to 250.00 dBm. The default setting is 0.00 dBm. However, since the **Scale Coupling** default is **On**, this value is automatically determined by the measurement result. When you set a value manually, **Scale Coupling** automatically changes to **Off**.
- **Ref Position** - Sets the reference position to either **Top**, **Ctr** (center) or **Bot** (bottom). The default setting is **Top**.
- **Scale Coupling** - Toggles the scale coupling function between **On** and **Off**. The default setting is **On**. Upon pressing the **Restart** front-panel key or **Restart** softkey under the **Meas Control** menu, this function automatically determines the scale per division and reference values based on the measurement results. When you set a value to either **Scale/Div** or **Ref Value** manually, **Scale Coupling** automatically changes to **Off**.

---

**NOTE**

For E4406A with Option B7C, if the **Linear Envelope** window is active in the **Linear Envelope** view, the **AMPLITUDE Y Scale** key accesses the following menu:

- **Scale/Div** - Sets the vertical scale by changing an amplitude value per division. The range is 1.00 nV to 20.00 V per division. The default setting is 100.0 mV per division. However, since the **Scale Coupling** default is **On**, this value is automatically determined by the measurement result. When you set a value manually, **Scale Coupling** automatically changes to **Off**.
- **Ref Value** - Sets the reference value ranging from -250.00 to 250.00 V. The default setting is 0.00 V. However, since the **Scale Coupling** default is **On**, this value is automatically determined by the measurement result. When you set a value manually, **Scale Coupling** automatically changes to **Off**.
- **Ref Position** - Sets the reference position to either **Top**, **Ctr** (center) or **Bot** (bottom). The default setting is **Top**.

Key Reference  
Measurement Keys

- **Scale Coupling** - Toggles the scale coupling function between **On** and **Off**. The default setting is **On**. Upon pressing the **Restart** front-panel key or **Restart** softkey under the **Meas Control** menu, this function automatically determines the scale per division and reference values based on the measurement results. When you set a value to either **Scale/Div** or **Ref Value** manually, **Scale Coupling** automatically changes to **Off**.

---

**NOTE**

For E4406A with Option B7C, if the Phase window is active in the **Linear Envelope** view, the **AMPLITUDE Y Scale** key accesses the menu to modify the following parameters:

- **Scale/Div** - Sets the vertical scale by changing an amplitude value per division. The range is 0.10 to 3600.0 deg per division. The default setting is 30.00 deg. However, since the **Scale Coupling** default is **On**, this value is automatically determined by the measurement result. When you set a value manually, **Scale Coupling** automatically changes to **Off**.
- **Ref Value** - Sets the reference value ranging from -36000.0 to 36000.0 deg. The default setting is 0.00 deg. However, since the **Scale Coupling** default is **On**, this value is automatically determined by the measurement result. When you set a value manually, **Scale Coupling** automatically changes to **Off**.
- **Ref Position** - Sets the reference position to either **Top**, **Ctr** (center) or **Bot** (bottom). The default setting is **Ctr**.
- **Scale Coupling** - Toggles the scale coupling function between **On** and **Off**. The default setting is **On**. Upon pressing the **Restart** front-panel key or **Restart** softkey under the **Meas Control** menu, this function automatically determines the scale per division and reference values based on the measurement results. When you set a value to either **Scale/Div** or **Ref Value** manually, **Scale Coupling** automatically changes to **Off**.

---

**NOTE**

If the I/Q Waveform window is active in the **I/Q Waveform** view (or the I Waveform, or Q Waveform window is active in the **I and Q Waveform** view for E4406A with Option B7C), the **AMPLITUDE Y Scale** key accesses the menu to modify the following parameters:

- **Scale/Div** - Sets the vertical scale by changing an amplitude value per division. The range is 1.00 nV to 20.00 V per division. The default setting is 100.0 mV. However, since the **Scale Coupling** default is **On**, this value is automatically determined by the measurement result. When you set a value manually, **Scale Coupling** automatically changes to **Off**.
- **Ref Value** - Sets the reference value ranging from -250.00 to 250.00 V. The default setting is 0.00 V. However, since the **Scale Coupling**

default is **On**, this value is automatically determined by the measurement result. When you set a value manually, **Scale Coupling** automatically changes to **Off**.

- **Ref Position** - Sets the reference position to either **Top**, **Ctr** (center) or **Bot** (bottom). The default setting is **Ctr**.
- **Scale Coupling** - Toggles the scale coupling function between **On** and **Off**. The default setting is **On**. Upon pressing the **Restart** front-panel key or **Restart** softkey under the **Meas Control** menu, this function automatically determines the scale per division and reference values based on the measurement results. When you set a value to either **Scale/Div** or **Ref Value** manually, **Scale Coupling** automatically changes to **Off**.

---

**NOTE**

For E4406A, if the  $I/Q$  Polar window is active in the **I/Q Polar** view, the **SPAN X Scale** or **AMPLITUDE Y Scale** key accesses the menu to modify the following parameters:

- **I/Q Scale/Div** - Sets the vertical and horizontal scales by changing a value per division. The range is 1.00 nV to 20.00 V per division. The default setting is 100.0 mV.
- **I or Q Origin** - Sets the reference value ranging from -250.00 to 250.00 V. The default setting is 0.00 V.

### Display Key Menu

The **Display** key is not available for this measurement.

### Marker Key Menu

Key Path: **Marker**

The **Marker** front-panel key accesses the menu to configure the markers.

- **Select 1 2 3 4** - Activates up to four markers with the corresponding numbers, respectively. The selected number is underlined and its function is defined by pressing the **Function** key. The default is 1.
- **Normal** - Activates the selected marker to read the time position and amplitude of the marker on the RF envelope or Signal Envelope trace. Marker position is controlled by the **RPG** knob.
- **Delta** - Reads the differences in frequency and either time position or amplitude, between the selected marker and the next marker.
- **Function Off** - Selects the marker function to be **Band Power**, **Noise**, or **Off**. The default is **Off**. If set to **Band Power**, you need to select **Delta**.
- **Trace** - Places the selected marker on **RF Envelope** (for PSA), **Signal Envelope** (for E4406A), or **I/Q Waveform**. Also, for E4406A with Option B7C, you can place the marker on **Linear Envelope**, **Linear Phase**, **I Waveform**, or **Q Waveform**.

[Key Reference](#)[Measurement Keys](#)

- **Off** - Turns off the selected marker.
- **Shape Diamond** - Accesses the menu to define the selected marker shape to be **Diamond**, **Line**, **Square**, or **Cross**. The default shape is **Diamond**.
- **Marker All Off** - Turns off all of the markers.

**Peak Search Key**

Key Path: **Search**

The front panel **Search** key performs a peak search when pressed. A marker will automatically be activated at the highest peak.

---

**NOTE**

In the Waveform measurement, the `Mean Pwr (Entire Trace)` value plus the `Pk-to-Mean` value will sum to equal the current `Max Pt.` value as shown in the data window below the RF Envelope or Signal Envelope display. If you do a marker peak search (**Search**) with averaging turned off, the marker will find the same maximum point. However, if you turn averaging on, the `Pk-to-Mean` value will use the highest peak found for any acquisition during averaging, while the marker peak will look for the peak of the display, which is the result of n-averages. This will usually result in differing values for the maximum point.

---

---

## Baseband I/Q Inputs (Option B7C ) Keys

### Input Port Key Menu

Key Path: **Mode Setup, Input**

Option B7C adds a softkey menu that lets you select I/Q inputs. This menu is located under the **Input/Output** front-panel key. To select an input connector press **Input/Output**, or **Input Port** under **Mode Setup**. Select the desired input connector(s) from the following choices displayed:

- **RF** - Press to select the 50  $\Omega$  N-type RF connector.
- **I/Q** - Select if using 2-connector “unbalanced” or 4-connector “balanced” I/Q connections. Complete your selection by choosing the appropriate input impedance and connectors in the section “[I/Q Input Z Key Menu](#)” on page 248.
- **I only** - Select if using I and/or  $\bar{I}$  input connectors (available in the Basic mode). Complete your selection by choosing the appropriate input impedance and connectors in the section “[I/Q Input Z Key Menu](#)” on page 248.
- **Q only** - Select if using Q and/or  $\bar{Q}$  input connectors (available in the Basic mode). Complete your selection by choosing the appropriate input impedance and connectors in the section “[I/Q Input Z Key Menu](#)” on page 248.
- **50 MHz Ref** - Select to view the 50 MHz CW calibration signal (signal level is approximately -25.0 dBm).
- **IF Align** - Select to view the IF alignment signal. This signal is available as a diagnostic function, to check the operation of the alignment signal in the case of alignment failure. Once selected, a menu accessing the IF alignment signal parameters is available at the bottom of the **Input** menu. Either CW, comb, or pulse signals may be selected. Because the alignment signal is input at the IF frequency, it is displayed on any active Spectrum (Freq Domain) window, regardless of center frequency.
- **Baseband Align Signal** - Select **On** to view the baseband alignment signal. This is available as a diagnostic function, to check the operation of the alignment signal in the case of alignment failure. Because the alignment signal is input at the IF frequency, it is displayed on any Spectrum (Freq Domain) window.

## I/Q Setup Key Menu

Key Path: **Mode Setup, Input**

- **I Offset** - Use to enter a voltage value to offset the measured I value. The default value is 0.0000 V. The range is  $-2.5600$  to  $+2.5600$  V. The tuning increment depends on the **I/Q Range** setting as shown in [Table 3-16](#). This value only affects the displayed results, and does not appear as a correcting voltage at the probe.

Table 3-16

### I and Q Offset Increment vs. I/Q Range

I/Q Range	I and Q Offset Increment
1 V	2 mV
500 mV	1 mV
250 mV	.5 mV
125 mV	.25 mV

- **Q Offset** - Use to enter a voltage value to offset the measured Q value. The default value is 0.0000 V. The range is  $-2.5600$  to  $+2.5600$  V. The tuning increment depends on the **I/Q Range** setting as shown in [Table 3-16](#). This value only affects the displayed results, and does not appear as a correcting voltage at the probe.
- **I/Q Input Z** - Allows you to access a menu to select an input impedance for baseband I/Q input signals. The selection of input impedance is coupled to a connector “balance” configuration. If **I/Q Input Z** is set to  $1\text{ M}\Omega$ , the setting for **I/Q Z Ref for Input Z =  $1\text{ M}\Omega$**  key becomes effective. For details, refer to “[I/Q Input Z Key Menu](#)” on page 248.
- **I/Q Z Ref for Input Z =  $1\text{ M}\Omega$**  - Allows you to select the  $1\text{ M}\Omega$  input reference Z value in Ohms. This key is effective only when **I/Q Input Z** is set to a  $1\text{ M}\Omega$  setting. The default value is  $50.0\ \Omega$ . The range is  $1.0\ \Omega$  to  $10\text{ M}\Omega$ , with a tuning increment of  $1.0\ \Omega$ . For more details, refer to “[I/Q Input Z Key Menu](#)” on page 248.

## I/Q Input Z Key Menu

Key Path: **Mode Setup, Input, I/Q Setup**

To select an input impedance, press **Input/Output, I/Q Setup, I/Q Input Z** to display the following menu:

- **50  $\Omega$  Unbalanced** - Select to use I and/or Q input connectors.
- **600  $\Omega$  Balanced** - Select to use either I and  $\bar{I}$ , Q and  $\bar{Q}$ , or all four I, Q,  $\bar{I}$ , and  $\bar{Q}$  input connectors.
- **1  $\text{M}\Omega$  Unbalanced** - This is the default input connector setting. Select to use I and/or Q input connectors in an unbalanced mode. When **I/Q Input Z** is set to  $1\text{ M}\Omega$  (either balanced or unbalanced), the setting for



I/Q Z Ref for Input Z = 1 M $\Omega$  key may be adjusted. Otherwise, the default value for I/Q Z Ref = 1 M $\Omega$  is 50  $\Omega$ .

- **1 M $\Omega$  Balanced** - Select to use either I and  $\bar{I}$ , Q and  $\bar{Q}$ , or all four I, Q,  $\bar{I}$ , and  $\bar{Q}$  input connectors to make a balanced measurement. When I/Q Input Z is set to 1 M $\Omega$  (either balanced or unbalanced, the setting for I/Q Z Ref for Input Z = 1 M $\Omega$  key may be adjusted. Otherwise, the default value for I/Q Z Ref for Input Z = 1 M $\Omega$  is 50  $\Omega$ .

## I/Q Range Key Menu

**NOTE** You must have I/Q selected under Key Path: Mode Setup, Input, Input Port to make this menu available

Key Path: Mode Setup, Input

The **I/Q Range** key lets you select one of four levels as an upper limit for the signal being applied to the baseband I/Q inputs. The level may be selected in units of dBm, dBmV, dB $\mu$ V, V, and W. The following table shows the four-level selections available for each unit of measure: The default is 1 V.

The **I/Q Range** power levels in [Table 3-17](#) are based on an **I/Q Input Z** of 50 $\Omega$ . **I/Q Range** voltage levels are independent of **I/Q Input Z**.

**Table 3-17**

**I/Q Range Settings by Displayed Unit of Measure**

Unit of Measure	Highest Setting			Lowest Setting
dBm	13.0	7.0	1.0	-5.1
dBmV	60	54	48	41.9
dB $\mu$ V	120.0	114.0	108	101.9
V	1.000	500 m	250 m	125 m
W	20.0 m	5.0 m	1.2 m	310.0 $\mu$

If **I/Q Range** is set below the default and the error message “Input Overload” is displayed, this value may be adjusted to its maximum. Beyond that point, the signal must be attenuated to preserve the measurement accuracy. Using a lower value than the default can provide an increased dynamic measurement range.

## Baseband I/Q Key Access Locations

All baseband I/Q input setup and operation features can be located by using the key access table below. The key access path shows the key sequence you enter to access a particular key.

Some features can only be used when specific measurements are active. If a feature is not currently valid the key label for that feature appears as lighter colored text or is not displayed at all.

**Table 3-18 Baseband I/Q Key Access Locations**

Key	Key Access Path
Align IQ	System>Alignments>Align Subsystem>
Baseband Align Signal	Mode Setup>Input>Input Port>
dBm	Input/Output>I/Q Range>
dBm	Mode Setup>Input>I/Q Range>
dBmv	Input/Output>I/Q Range>
dBmv	Mode Setup>Input>I/Q Range>
dBuv	Input/Output>I/Q Range>
dBuv	Mode Setup>Input>I/Q Range>
I and Q Waveform	View/Trace> (Waveform Measurement)
I Offset	Input/Output>I/Q Setup>
I Offset	Mode Setup>Input>I/Q Setup>
I/Q	Input/Output>Input Port>
I/Q	Mode Setup>Input>Input Port>
I/Q Input Z	Input/Output>I/Q Setup>
I/Q Input Z	Mode Setup>Input>I/Q Setup>
I/Q Polar	View/Trace>
I/Q Range	Input/Output>
I/Q Range	Mode Setup>Input>
I/Q Setup	Input/Output>
I/Q Setup	Mode Setup>Input>
I/Q Waveform	View/Trace>
I/Q Waveform	Marker>Trace>
I/Q Z Ref for Input Z = 1 MΩ	Mode Setup>Input>I/Q Setup>
I Waveform	View/Trace> (Spectrum Measurement)

Table 3-18

### Baseband I/Q Key Access Locations

Key	Key Access Path
<b>Linear Envelope</b>	View/Trace> (Waveform Measurement)
<b>Q Offset</b>	Input/Output>Input>I/Q Setup>
<b>Q Offset</b>	Mode Setup>Input>I/Q Setup>
<b>Q Waveform</b>	Marker>Trace>
<b>Signal Envelope</b>	View/Trace> (Waveform Measurement)
<b>Spectrum Linear</b>	View/Trace> (Spectrum Measurement)
<b>V(olts)</b>	Mode Setup>Input>I/Q Setup>I Offset (or Q Offset)>Keypad Entry
<b>Volts</b>	Input/Output>I/Q Range>
<b>Volts</b>	Mode Setup>Input>I/Q Range>
<b>Watts</b>	Input/Output>I/Q Range>
<b>Watts</b>	Mode Setup>Input>I/Q Range>

---

## 4 Programming Commands

These commands are only available when the GSM or EDGE/GSM mode has been selected using **INSTRUMENT:SElect EDGE GSM**. If the GSM or EDGE/GSM mode is selected, commands that are unique to another mode are not available.

## **SCPI Command Subsystems**

- “CALCulate Subsystem” on page 260
- “CONFigure Subsystem” on page 311
- “DISPlay Subsystem” on page 312
- “FETCh Subsystem” on page 324
- “FORMat Subsystem” on page 325
- “INITiate Subsystem” on page 327
- “INSTrument Subsystem” on page 329
- “MEASure Group of Commands” on page 332
- “READ Subsystem” on page 371
- “SENSe Subsystem” on page 372
- “TRIGger Subsystem” on page 502

## Programming Command Compatibility Across Model Numbers and Across Modes

### Across PSA Modes: Command Subsystem Similarities

When you select different modes you get different sets of available programming commands. That is, *only* the commands that are appropriate for the current mode are available. Also, some commands have the same syntax in different modes but have different ranges or settings that are only appropriate to the current mode.

The following table shows which command subsystems are the same across different modes. If there is no “X” by a particular subsystem, then the set of available commands is different in those modes. Command ranges or defaults may also be different. Refer to the programming command descriptions in the documentation for each mode for details.

Command Subsystem	Same command set is available:  SA mode compared with the application modes: W-CDMA, cdmaOne, cdma2000, 1xEV-DO, Basic, GSM, EDGE, NADC, or PDC	Same command set is available:  SA mode compared with the application mode: Phase Noise
IEEE common commands	X	X
ABORt	X	X
CALCulate		
CALibration	X	X
CONFigure		
COUPle	not available in these application modes	not available in this application modes
DISPlay		
FETCh		
FORMat		X
HCOPy	X	X
INITiate		
INPut	not available in these application modes	X

Command Subsystem	Same command set is available:  SA mode compared with the application modes: W-CDMA, cdmaOne, cdma2000, 1xEV-DO, Basic, GSM, EDGE, NADC, or PDC	Same command set is available:  SA mode compared with the application mode: Phase Noise
MEASure		
MEMory	X	X
MMEMory	X	X
MMEMory:STORe:TRACe	not available in application modes	X
READ		
[SENSe] [SENSe:]CHANnel [SENSe:]CORRection [SENSe:]FEED [SENSe:]FREQuency:CE NTer [SENSe:]FREQuency: <other subsystems> [SENSe:]<measurement> [SENSe:]POWer [SENSe:]RADio [SENSe:]SYNC	X  not available in application modes	  not available in application modes
STATus	X	X
SYSTem	X	X
TRACe	not available in application modes	X
TRIGger		
UNIT	X	X



## Across PSA Modes: Specific Command Differences

Some programming commands operate differently depending on which Mode the analyzer is set to.

Command	Spectrum Analysis, Phase Noise and Noise Figure Mode	Basic, cdmaOne, cdma2000, 1xEV-DO, W-CDMA, GSM, EDGE, NADC, PDC Modes
CONFigure: <measurement>	Accesses the measurement and sets the instrument settings to the defaults. Averaging is turned on and set to 10. The instrument is put in single measurement mode. It does not initiate a measurement. Use INIT:IMM to make one measurement.	Accesses the measurement and sets the instrument settings to the defaults. If you were already in single measurement mode, it takes one measurement and then waits. If you were in continuous measurement mode it continues to measure.
*ESE default	Default is 255 which means that every error/status bit change that has occurred will be returned with a *ESR? query. You must set the value of *ESE to choose only the bits/status that you want returned.	Default is 0 which means that none of the error/status bit changes that have occurred will be returned with a *ESR? query. You must set the value of *ESE to choose the bits/status that you want returned.
TRIGger commands	For these modes, only one trigger source can be selected and it will be common across the modes. Also, only one value can be set for the trigger delay, level, or polarity.	For these modes, a unique trigger source can be selected for each mode. Also, each trigger source can have unique settings for the its delay, level, and polarity.
Saving and recalling traces	Traces can only be saved when in the Spectrum Analysis mode (MMEM:STOR:TRAC). This is because the instrument state must be saved along with the trace data and the state data varies depending on the number of modes currently available in the instrument.	

## Using Applications in PSA Series vs. VSA E4406A

## NOTE

This information *only* applies to the application modes:

Basic, cdmaOne, cdma2000, 1xEV-DO, W-CDMA, GSM, EDGE, NADC, and PDC.

Command	PSA Series	VSA E4406A: A.04.00	VSA E4406A: A.05.00
*RST	Resets instrument, putting it in continuous measurement mode. Use INIT:CONT OFF to select single measurement mode and INIT:IMM to start one measurement.	Resets instrument, putting it in single measurement mode. One measurement is initiated when the command is sent.	Resets instrument, putting it in single measurement mode. No measurement is initiated when the command is sent. Use INIT:IMM to start one measurement.
CONFigure: <measurement>	Accesses the measurement and sets the instrument settings to the defaults. If you were already in single measurement mode, it takes one measurement and then waits.	Same as PSA. Accesses the measurement and sets the instrument settings to the defaults. If you were already in single measurement mode, it takes one measurement and then waits.	Accesses the measurement and sets the instrument settings to the defaults. If you were already in single measurement mode, it does not initiate a measurement. Use INIT:IMM to make one measurement.
*ESE default	Default is 255 which means that every error/status bit change that has occurred will be returned with a *ESR? query. You must set the value of *ESE to choose only the bits/status that you want returned.	Default is 0 which means that none of the error/status bit changes that have occurred will be returned with a *ESR? query. You must set the value of *ESE to choose the bits/status that you want returned.	Same as VSA A.04.00. Default is 0 which means that none of the error/status bit changes that have occurred will be returned with a *ESR? query. You must set the value of *ESE to choose the bits/status that you want returned.
*LRN	The command is <i>not</i> available.	The command is available.	The command is available.

Command	PSA Series	VSA E4406A: A.04.00	VSA E4406A: A.05.00
TRIGger commands	<p>In Spectrum Analysis mode only one value can be set for the trigger's source, delay, level, or polarity.</p> <p>Basic, GSM, EDGE, cdmaOne, cdma2000, W-CDMA, NADC, PDC modes function the same as VSA</p>	<p>You can select a unique trigger source for each mode. Each trigger source can have unique settings for the its delay, level, and polarity.</p>	<p>Same as VSA A.04.00.</p> <p>You can select a unique trigger source for each mode. Each trigger source can have unique settings for the its delay, level, and polarity.</p>
AUTO ON   OFF control and setting manual values	<p>We recommend that you set a function's automatic state to OFF, before you send it your manual value.</p> <p>Some functions will turn off the automatic mode when you send a specific manual value, but others will not. This also varies with the instrument model.</p>	<p>We recommend that you set a function's automatic state to OFF, before you send it your manual value.</p> <p>Some functions will turn off the automatic mode when you send a specific manual value, but others will not. This also varies with the instrument model.</p>	<p>We recommend that you set a function's automatic state to OFF, before you send it your manual value.</p> <p>Some functions will turn off the automatic mode when you send a specific manual value, but others will not. This also varies with the instrument model.</p>

## CALCulate Subsystem

This subsystem is used to perform post-acquisition data processing. In effect, the collection of new data triggers the CALCulate subsystem. In this instrument, the primary functions in this subsystem are markers and limits.

The SCPI default for data output format is ASCII. The format can be changed to binary with FORMat:DATA which transports faster over the bus.

## Test Current Results Against all Limits

**:CALCulate:CLIMits:FAIL?**

Queries the status of the current measurement limit testing. It returns a 0 if the measured results pass when compared with the current limits. It returns a 1 if the measured results fail any limit tests.

## Data Query

**:CALCulate:DATA[n]?**

Returns the designated measurement data for the currently selected measurement and sub-opcode.

*n* = any valid sub-opcode for the current measurement. See the [“MEASure Group of Commands” on page 519](#) for information on the data that can be returned for each measurement.

For sub-opsodes that return trace data use the `:CALCulate:DATA[n]:COMPRESS?` command below.

## Calculate/Compress Trace Data Query

```
:CALCulate:DATA<n>:COMPRESS?
BLOCK|CFIT|MAXimum|MINimum|MEAN|DMEan|RMS
|SAMPLE|SDEVIation
[,<soffset>[,<length>[,<roffset>[,<rlimit>]]]]
```

Returns compressed data for the specified trace data. The data is returned in the same units as the original trace and only works with the currently selected measurement. The command is used with a sub-opcode *<n>* since measurements usually return several types of trace data. See the following table for the sub-opcodes for the trace data names that are available in each measurement. For sub-opcodes that return scalar data use the `:CALCulate:DATA[n]?` command above.

This command is used to compress or decimate a long trace to extract and return only the desired data. A typical example would be to acquire N frames of GSM data and return the mean power of the first burst in each frame. The command can also be used to identify the best curve fit for the data.

**BLOCK** or block data - returns all the data points from the region of the trace data that you specify. For example, it could be used to return the data points of an input signal over several timeslots, excluding the portions of the trace data that you do not want.

**CFIT** or curve fit - applies curve fitting routines to the data. *<soffset>* and *<length>* are required to define the data that you want. *<roffset>* is an optional parameter for the desired order of the curve equation. The query will return the following values: the x-offset (in seconds) and the curve coefficients ((order + 1) values).

**MAX**, **MEAN**, **DME**, **MIN**, **RMS**, **SAMP** and **SDEV** return one data value for each specified region (or *<length>*) of trace data, for as many regions as possible until you run out of trace data (using *<roffset>* to specify regions). Or they return the number regions you specify (using *<rlimit>*) ignoring any data beyond that.

- **MAXimum** - returns the maximum data point for the specified region(s) of trace data. For I/Q trace data, the maximum magnitude of the I/Q pairs is returned.
- **MINimum** - returns the minimum data point for the specified region(s) of trace data. For I/Q trace data, the minimum magnitude of the I/Q pairs is returned.

- **MEAN** - returns the arithmetic mean of the data point values for the specified region(s) of trace data, in the same units as the original trace data.

**Equation 4-1 Mean Value of Data Points for Specified Region(s)**

$$\text{MEAN} = \frac{1}{n} \sum_{X_i \in \text{region}(s)} X_i$$

where  $X_i$  is a data point value, and  $n$  is the number of data points in the specified region(s).

For I/Q trace data, the mean of the magnitudes of the I/Q pairs is returned.

NOTE: If the original trace data is in dB, this function returns the arithmetic mean of those log values, not the log of the mean power. The mean of the log is a superior measurement technique when measuring CW signals in the presence of noise; the mean of the power, expressed in dB, is useful in power measurements such as Channel Power. To accomplish measurement of the mean of the power, use the RMS option, or use power units (watts, W) in the original trace. When the original trace is in voltage units, this function returns the mean voltage. This is occasionally useful in EMI applications.

When the original trace is made of I/Q pairs, the magnitude (in voltage units) of the trace elements is used for the  $X_i$  terms, and the units of the returned value is volts.

**Equation 4-2 Mean Value of I/Q Data Pairs for Specified Region(s)**

$$\text{MEAN} = \frac{1}{n} \sum_{X_i \in \text{region}(s)} |X_i|$$

where  $|X_i|$  is the magnitude of an I/Q pair, and  $n$  is the number of I/Q pairs in the specified region(s).

- **DMEan** - returns the mean power (in dB/dBm) of the data point values (expressed in dB/dBm) for the specified region(s) of trace data.

DMEan was intended to be used for averaging of power trace data expressed in units of dBm or dB. For example, in CDMA chip power measurements (decision point power at chip timing), when the original trace data is expressed in dBm, and the measurement length is equal to or greater than 1 slot, DMEan is useful to calculate



the slot average power over the entire slot duration).

DMEan does not have any known application when the original trace data is in voltage or power (W) units. When the original trace is made of I/Q pairs, the magnitude (in voltage units) of the trace elements is used for the  $X_i$  terms, and the units of the returned value is volts. In other words, all I/Q compression functions act on the magnitude of the I/Q pairs, and are therefore only useful for decibel-formatted inputs.

**Equation 4-3 DMEan Value of Data Points for Specified Region(s)**

$$\text{DMEan} = 10 \times \log_{10} \left( \frac{1}{n} \sum_{X_i \in \text{region}(s)} \left( 10^{\frac{X_i}{10}} \right) \right)$$

- **RMS** - returns the arithmetic RMS (Root Means Squared) of the data point values for the specified region(s) of trace data, using the original units of measurement.

**Equation 4-4 RMS Value of Data Points for Specified Region(s)**

$$\text{RMS} = \sqrt{\frac{1}{n} \sum_{X_i \in \text{region}(s)} X_i^2}$$

where  $X_i$  is a data point value, and  $n$  is the number of data points in the specified region(s).

For I/Q trace data, the RMS of the magnitudes of the I/Q pairs is returned.

Note: This function is very useful for I/Q trace data. However, if the original trace data is in dB, this function returns the RMS of the log values which is not usually needed. Similarly, if the original trace data is in power units (W, watts), there is no known usefulness of this function.

Once you have the RMS value for a region of I/Q trace data, you may want to calculate the mean power. You must convert this RMS I/Q value (peak volts) to power in dB.

$$20 \times \text{Log}_{10}[10 \times (\text{rms value})] + 13$$

The value “13” above is derived from the use of a 50 ohm reference (−17 dB), and the conversion from dBW (decibels relative

to a watt) to dBm (+30 dBm for 1 Watt), giving a final value of +13.

When the original trace is made of I/Q pairs, the magnitude (in voltage units) of the trace elements is used for the  $X_i$  terms, and the units of the returned value is volts. Because the I/Q data represents a multiplier on assumed sine and cosine terms, the user's conversion from RMS voltage to power would be 3 dB different than if the  $X_i$  term were an envelope voltage; thus, the "+13" in the equation above would be +10.

- **SAMPLE** - returns the first data value for the specified region(s) of trace data. For I/Q trace data, the first I/Q pair is returned.
- **SDEVIation** - returns the arithmetic standard deviation for the data point values for the specified region(s) of trace data.

**Equation 4-5 Standard Deviation of Data Point Values for Specified Region(s)**

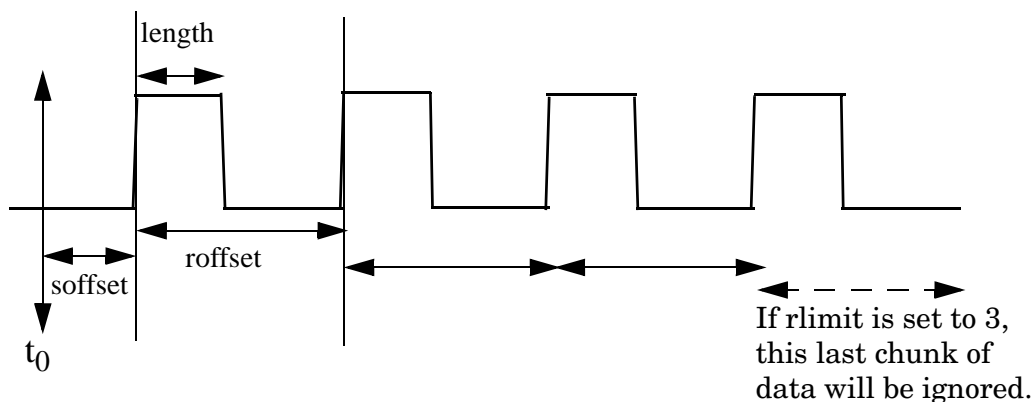
$$SDEV = \sqrt{\frac{1}{n} \sum_{X_i \in \text{region}(s)} (X_i - \bar{X})^2}$$

where  $X_i$  is a data point value,  $\bar{X}$  is the arithmetic mean of the data point values for the specified region(s), and  $n$  is the number of data points in the specified region(s).

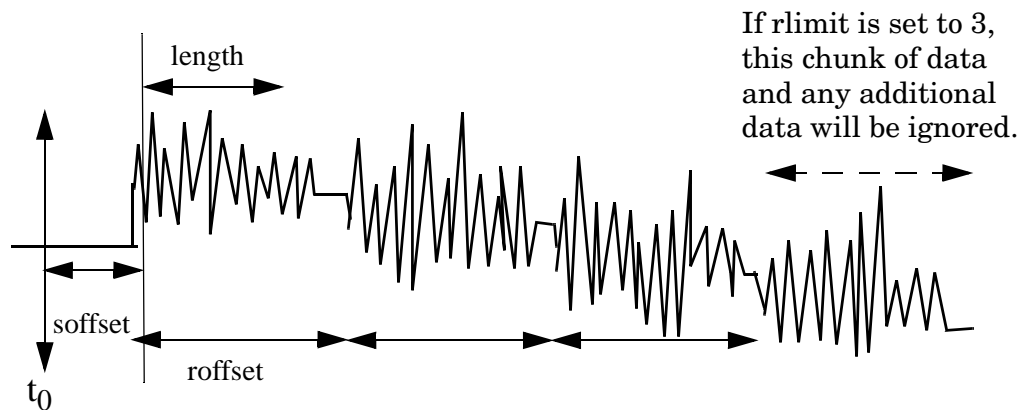
For I/Q trace data, the standard deviation of the magnitudes of the I/Q pairs is returned.

When the original trace is made of I/Q pairs, the magnitude (in voltage units) of the trace elements is used for the  $X_i$  terms, and the units of the returned value is volts.

**Figure 4-1 Sample Trace Data - Constant Envelope**



**Figure 4-2 Sample Trace Data - Not Constant Envelope**



<soffset> - start offset is an optional real number (in seconds). It specifies the amount of data at the beginning of the trace that will be ignored before the decimation process starts. It is the time from the start of the trace to the point where you want to start using the data. The default value is zero.

<length> - is an optional real number (in seconds). It defines how much data will be compressed into one value. This parameter has a default value equal to the current trace length.

<roffset> - repeat offset is an optional real number (in seconds). It defines the beginning of the next field of trace elements to be compressed. This is relative to the beginning of the previous field. This parameter has a default value equal to the <length> variable.

<rlimit> - repeat limit is an optional integer. It specifies the number of data items that you want returned. It will ignore any additional items beyond that number. You can use the Start offset and the Repeat limit to pick out exactly what part of the data you want to use. The default value is all the data.

Example: To query the mean power of a set of GSM bursts:

1. Set the waveform measurement sweep time to acquire at least one burst.
2. Set the triggers such that acquisition happens at a known position relative to a burst.
3. Then query the mean burst levels using, **CALC:DATA2:COMP? MEAN, 24e-6, 526e-6** (These parameter values correspond to GSM signals, where 526e-6 is the length of the burst in the slot and you just want 1 burst.)

**NOTE**

There is a more detailed example in the “Improving the Speed of Your Measurements” section in the PSA Series *User’s and Programmer’s Reference*. There is also a sample program in the Programming

Fundamentals chapter of that book, and a copy of it is on the documentation CD-ROM.

**NOTE** There is a more detailed example in the “Improving the Speed of Your Measurements” section in the E4406A *Programmer’s Guide*. There is also a sample program in the Programming Fundamentals chapter of that book, and a copy of it is on the documentation CD-ROM.

**Remarks:** The optional parameters must be entered in the specified order. For example, if you want to specify <length>, you must also specify <soffset>.

This command uses the data in the format specified by FORMat:DATA, returning either binary or ASCII data.

**History:** Added in revision A.03.00  
 Added in revision A.03.00  
 Changed in revision A.05.00

Measurement	Available Traces	Markers Available?
ACP - adjacent channel power (Basic, cdmaOne, cdma2000, W-CDMA, iDEN, WiDEN, NADC, PDC modes)	no traces ( $n=0$ ) <sup>a</sup> for I/Q points	no markers
BER - bit error rate (iDEN, WiDEN mode)	no traces ( $n=0$ ) <sup>a</sup> for I/Q data	no markers
CDPower - code domain power (cdmaOne mode)	POWer ( $n=2$ ) <sup>a</sup> TIMing ( $n=3$ ) <sup>a</sup> PHASe ( $n=4$ ) <sup>a</sup> ( $n=0$ ) <sup>a</sup> for I/Q points	yes
CDPower - code domain power (cdma2000, W-CDMA modes)	CDPower ( $n=2$ ) <sup>a</sup> EVM ( $n=5$ ) <sup>a</sup> MERRor ( $n=6$ ) <sup>a</sup> PERRor ( $n=7$ ) <sup>a</sup> SPOWer ( $n=9$ ) <sup>a</sup> CPOWer ( $n=10$ ) <sup>a</sup> ( $n=0$ ) <sup>a</sup> for I/Q points	yes

Measurement	Available Traces	Markers Available?
CHPower - channel power (Basic, cdmaOne, cdma2000, W-CDMA modes)	SPECTrum ( $n=2$ ) <sup>a</sup> ( $n=0$ ) <sup>a</sup> for I/Q points	no markers
CSPur - spurs close (cdmaOne mode)	SPECTrum ( $n=2$ ) <sup>a</sup> ULIMit ( $n=3$ ) <sup>a</sup> ( $n=0$ ) <sup>a</sup> for I/Q points	yes
EEVM - EDGE error vector magnitude (EDGE mode)	EVMerror ( $n=2$ ) <sup>a</sup> MERRor ( $n=3$ ) <sup>a</sup> PERRor ( $n=4$ ) <sup>a</sup> ( $n=0$ ) <sup>a</sup> for I/Q points	yes
EORFspectr - EDGE output RF spectrum (EDGE mode)	RFEMod ( $n=2$ ) <sup>a</sup> RFESwitching ( $n=3$ ) <sup>a</sup> SPEMod ( $n=4$ ) <sup>a</sup> LIMMod ( $n=5$ ) <sup>a</sup> ( $n=0$ ) <sup>a</sup> for I/Q points	yes, only for a single offset  yes, only for multiple offsets
EPVTime - EDGE power versus time (EDGE mode)	RFENvelope ( $n=2$ ) <sup>a</sup> UMASk ( $n=3$ ) <sup>a</sup> LMASk ( $n=4$ ) <sup>a</sup> ( $n=0$ ) <sup>a</sup> for I/Q points	yes
ETSPur - EDGE transmit band spurs (EDGE mode)	SPECTrum ( $n=2$ ) <sup>a</sup> ULIMit ( $n=3$ ) <sup>a</sup> ( $n=0$ ) <sup>a</sup> for I/Q points	yes
EVM - error vector magnitude (NADC, PDC modes)	EVM ( $n=2$ ) <sup>a</sup> MERRor ( $n=3$ ) <sup>a</sup> PERRor ( $n=4$ ) <sup>a</sup> ( $n=0$ ) <sup>a</sup> for I/Q points	yes

Measurement	Available Traces	Markers Available?
EVMQpsk - QPSK error vector magnitude (cdma2000, W-CDMA modes)	EVM ( $n=2$ ) <sup>a</sup> MERRor ( $n=3$ ) <sup>a</sup> PERRor ( $n=4$ ) <sup>a</sup> ( $n=0$ ) <sup>a</sup> for I/Q points	yes
IM - intermodulation (cdma2000, W-CDMA modes)	SPECTrum ( $n=2$ ) <sup>a</sup> ( $n=0$ ) <sup>a</sup> for I/Q points	yes
MCPower - multi-carrier power (W-CDMA mode)	no traces ( $n=0$ ) <sup>a</sup> for I/Q points	no markers
OBW - occupied bandwidth (cdmaOne, cdma2000, iDEN, WiDEN, PDC, W-CDMA modes)	no traces ( $n=0$ ) <sup>a</sup> for I/Q points	no markers
ORFSpectrum - output RF spectrum (GSM, EDGE mode)	RFEMod ( $n=2$ ) <sup>a</sup> RFESwitching ( $n=3$ ) <sup>a</sup> SPEMod ( $n=4$ ) <sup>a</sup> LIMMod ( $n=5$ ) <sup>a</sup> ( $n=0$ ) <sup>a</sup> for I/Q points	yes, only for a single offset  yes, only for multiple offsets
PFERror - phase and frequency error (GSM, EDGE mode)	PERRor ( $n=2$ ) <sup>a</sup> PFERror ( $n=3$ ) <sup>a</sup> RFENvelope ( $n=4$ ) <sup>a</sup> ( $n=0$ ) <sup>a</sup> for I/Q points	yes
PSTatistic - power statistics CCDF (Basic, cdma2000, W-CDMA modes)	MEASured ( $n=2$ ) <sup>a</sup> GAUSian ( $n=3$ ) <sup>a</sup> REFerence ( $n=4$ ) <sup>a</sup> ( $n=0$ ) <sup>a</sup> for I/Q points	yes
PVTime - power versus time (GSM, EDGE, Service modes)	RFENvelope ( $n=2$ ) <sup>a</sup> UMASk ( $n=3$ ) <sup>a</sup> LMASk ( $n=4$ ) <sup>a</sup> ( $n=0$ ) <sup>a</sup> for I/Q points	yes

Measurement	Available Traces	Markers Available?
RHO - modulation quality (cdmaOne, cdma2000, W-CDMA mode)	( $n=0$ ) <sup>a</sup> for I/Q points EVM ( $n=2$ ) <sup>a</sup> MERRor ( $n=3$ ) <sup>a</sup> PERRor ( $n=4$ ) <sup>a</sup> ( $n=0$ ) <sup>a</sup> for I/Q points	yes
SEMask - spectrum emissions mask (cdma2000, W-CDMA mode)	SPECtrum ( $n=2$ ) <sup>a</sup> ( $n=0$ ) <sup>a</sup> for I/Q points	yes
TSPur - transmit band spurs (GSM, EDGE mode)	SPECtrum ( $n=2$ ) <sup>a</sup> ULIMit ( $n=3$ ) <sup>a</sup> ( $n=0$ ) <sup>a</sup> for I/Q points	yes
TXPower - transmit power (GSM, EDGE mode)	RFENvelope ( $n=2$ ) <sup>a</sup> IQ ( $n=8$ ) <sup>a</sup> ( $n=0$ ) <sup>a</sup> for I/Q points	yes
SPECtrum - (frequency domain) (all modes)	RFENvelope ( $n=2$ ) <sup>a</sup> for Service mode IQ ( $n=3$ ) <sup>a</sup> SPECtrum ( $n=4$ ) <sup>a</sup> ASpectrum ( $n=7$ ) <sup>a</sup> ( $n=0$ ) <sup>a</sup> for I/Q points	yes
WAVEform - (time domain) (all modes)	RFENvelope ( $n=2$ ) <sup>a</sup> (also for Signal Envelope trace) IQ ( $n=5$ ) <sup>a</sup> ( $n=0$ ) <sup>a</sup> for I/Q points	yes

a. The  $n$  number indicates the sub-opcode that corresponds to this trace. Detailed descriptions of the trace data can be found in the MEASure subsystem documentation by looking up the sub-opcode for the appropriate measurement.

## Calculate Peaks of Trace Data

**:CALCulate:DATA<n>:PEAKs?**  
**<threshold>, <excursion> [, AMPLitude | FREQuency | TIME]**

Returns a list of peaks for the designated trace data *n* for the currently selected measurement. The peaks must meet the requirements of the peak threshold and excursion values.

The command can only be used with specific *<n>* (sub-opcode) values, for measurement results that are trace, or scalar, data. See the table above for the appropriate sub-opcodes. Both real and complex traces can be searched, but complex traces are converted to magnitude in dBm. Sub-opcode *n=0*, is the raw trace data which cannot be searched for peaks. Sub-opcode *n=1*, is the scalar data which also cannot be searched for peaks.

Threshold - is the level below which trace data peaks are ignored

Excursion - To be defined as a peak, the signal must rise above the threshold by a minimum amplitude change (excursion). Excursion is measured from the lowest point above the threshold (of the rising edge of the peak), to the highest signal point that begins the falling edge. If a signal valley is higher than the threshold, then the excursion is referenced to that valley, and a peak is only defined if the signal following that valley exceeds the excursion.

Amplitude - lists the peaks in order of descending amplitude, so the highest peak is listed first. This is the default peak order listing if the optional parameter is not specified.

Frequency - lists the peaks in order of occurrence, left to right across the x-axis

Time - lists the peaks in order of occurrence, left to right across the x-axis

Example:       Select the spectrum measurement.

Use **CALC:DATA4:PEAK? -40,10,FREQ** to identify the peaks above -40 dBm, with excursions of at least 10 dB, in order of increasing frequency.

Query Results: Returns a list of floating-point numbers. The first value in the list is the number of peak points that follow. A peak point consists of two values: a peak amplitude followed by the its corresponding frequency (or time).

If no peaks are found the peak list will consist of only the number of peaks, (0).

The peak list is limited to 100 peaks. Peaks in excess of 100 are ignored.

Remarks:       This command uses the data setting specified by the



FORMat:DATA command and can return real 32-bit, real 64-bit, or ASCII data. The default data format is ASCII.

History: For E4406A:  
Added in revision A.03.00 and later

## CALCulate EDGE EVM Subsystem

### EDGE EVM–95% tile EVM Limit (Radio Type is BTS, Test Condition is Extreme)

**:CALCulate:EEVM:LIMit:BTS:EXTReMe:EVMP95 <real>**

**:CALCulate:EEVM:LIMit:BTS:EXTReMe:EVMP95?**

Mode:	GSM
Key Path:	<b>Meas Setup, Limit</b>
Default Terminator:	percent
Factory Preset:	11.0 percent
State Saved:	Saved in instrument state.
Range:	0.0 to 100.0
Min:	0.0
Max:	100.0
SCPI Resolution:	0.1
Notes:	This parameter can only set front panel using “Limits” key if the device selected by “Device” key is BTS and “Test Condition” is Extreme.
Step:	1.0
Soft Key Label:	95% tile EVM
Example:	:CALC:EEVM:LIM:BTS:EXTR:EVMP95 15

### EDGE EVM–Frequency Error Limit (Radio Type is BTS, BTS Type is Normal, Test Condition is Extreme)

**:CALCulate:EEVM:LIMit:BTS:EXTReMe:FERRor <real>**

**:CALCulate:EEVM:LIMit:BTS:EXTReMe:FERRor?**

Mode:	GSM
Key Path:	<b>Meas Setup, Limit</b>
Active Function Text:	Frequency Error
SCPI Name:	Frequency Error Limit (BTS, Extreme)

Default Terminator:	Ppm
Factory Preset:	0.05 Ppm
State Saved:	Saved in instrument state.
Range:	0.0 to 50.0
Min:	0.0
Max:	50.0
SCPI Resolution:	0.01
Notes:	This parameter can only set front panel using “Limits” key if the device selected by “Device” key is BTS and “BTS Type” is Normal or Micro and “Test Condition” is Extreme.
RPG:	0.01
Step:	0.01
Soft Key Label:	Frequency Error
Example:	:CALC:EEVM:LIM:BTS:EXTR:FERR 0.1

### EDGE EVM–I/Q Origin Offset Limit (Radio Type is BTS, Test Condition is Extreme)

```
:CALCulate:EEVM:LIMit:BTS:EXTReme:IQOOffset <float>  
:CALCulate:EEVM:LIMit:BTS:EXTReme:IQOOffset?
```

Mode:	GSM
Key Path:	<b>Meas Setup, Limit</b>
Active Function Text:	I/Q Origin Offset
SCPI Name:	I/Q Origin Offset Limit (BTS, Extreme)
Default Terminator:	dBc
Factory Preset:	-35.0 dBc
State Saved:	Saved in instrument state.
Range:	-100.0 to 0.0
Min:	-100.0
Max:	0.0

Programming Commands  
CALCulate Subsystem

SCPI Resolution:	0.1
Dependencies and Couplings:	N/A
Notes:	This parameter can only set front panel using “Limits” key if the device selected by “Device” key is BTS and “Test Condition” is Extreme.
RPG:	0.1
Step:	1.0
Soft Key Label:	I/Q Origin Offset
Format (SCPI):	N/A
Remote Command Notes:	N/A
Example:	:CALC:EEVM:LIM:BTS:EXTR:IQOO -15
History:	Newly added.

**EDGE EVM–Peak EVM Limit (Radio Type is BTS, Test Condition is Extreme)**

**:CALCulate:EEVM:LIMit:BTS:EXTReme:PEVM <real>**

**:CALCulate:EEVM:LIMit:BTS:EXTReme:PEVM?**

Mode:	GSM
Key Path:	<b>Meas Setup, Limit</b>
Active Function Text:	Peak EVM
Default Terminator:	percent
Factory Preset:	22.0 percent
State Saved:	Saved in instrument state.
Range:	0.0 to 100.0
Min:	0.0
Max:	100.0
SCPI Resolution:	0.1
Notes:	This parameter can only set front panel using “Limits” key if the device selected by “Device” key is BTS and “Test Condition” is Extreme.

RPG: 0.1  
 Step: 1.0  
 Soft Key Label: Peak EVM  
 Example: :CALC:EEVM:LIM:BTS:EXTR 15

**EDGE EVM–RMS EVM Limit (Radio Type is BTS, Test Condition is Extreme)**

**:CALCulate:EEVM:LIMit:BTS:EXTReme:REVM <real>**  
**:CALCulate:EEVM:LIMit:BTS:EXTReme:REVM?**

Mode: GSM  
 Key Path: **Meas Setup, Limit**  
 Active Function Text: RMS EVM  
 Default Terminator: percent  
 Factory Preset: 8.0 percent  
 State Saved: Saved in instrument state.  
 Range: 0.0 to 100.0  
 Min: 0.0  
 Max: 100.0  
 SCPI Resolution: 0.1  
 Notes: This parameter can only set front panel using “Limits” key if the device selected by “Device” key is BTS and “Test Condition” is Extreme.  
 RPG: 0.1  
 Step: 1.0  
 Soft Key Label: RMS EVM  
 Example: :CALC:EEVM:LIM:BTS:EXTR:REVM 15

**EDGE EVM–95% tile EVM Limit (Radio Type is BTS, Test Condition is Normal)**

**:CALCulate:EEVM:LIMit:BTS:NORMal:EVMP95 <real>**

**:CALCulate:EEVM:LIMit:BTS:NORMal:EVMP95?**

Mode:	GSM
Key Path:	<b>Meas Setup, Limit</b>
Active Function Text:	95% tile EVM
Default Terminator:	percent
Factory Preset:	11.0 percent
State Saved:	Saved in instrument state.
Range:	0.0 to 100.0
Min:	0.0
Max:	100.0
SCPI Resolution:	0.1
Notes:	This parameter can only set front panel using “Limits” key if the device selected by “Device” key is BTS and “Test Condition” is Normal.
RPG:	0.1
Step:	1.0
Soft Key Label:	95% tile EVM
Example:	:CALC:EEVM:LIM:BTS:NORM:EVMP95 12

**EDGE EVM–Frequency Error Limit (Radio Type is BTS, BTS Type is Normal, Test Condition is Normal)**

**:CALCulate:EEVM:LIMit:BTS:NORMal:FERRor <real>**

**:CALCulate:EEVM:LIMit:BTS:NORMal:FERRor?**

Mode:	GSM
Key Path:	<b>Meas Setup, Limit</b>
Active Function Text:	Frequency Error
Default Terminator:	ppm
Factory Preset:	0.05 ppm

State Saved:	Saved in instrument state.
Range:	0 to 50.0
Min:	0.0
Max:	50.0
SCPI Resolution:	0.01
Notes:	This parameter can only set front panel using “Limits” key if the device selected by “Device” key is BTS and “BTS Type” is Normal or Micro and “Test Condition” is Normal.
Step:	0.01
Soft Key Label:	Frequency Error
Example:	:CALC:EEVM:LIM:BTS:NORM:FERR 0.1

**EDGE EVM–I/Q Origin Offset Limit (Radio Type is BTS, Test Condition is Normal)**

**:CALCulate:EEVM:LIMit:BTS:NORMal:IQOffset <float>**  
**:CALCulate:EEVM:LIMit:BTS:NORMal:IQOffset?**

Mode:	GSM
Key Path:	<b>Meas Setup, Limit</b>
Active Function Text:	I/Q Origin Offset
Default Terminator:	dBc
Factory Preset:	-35 dBc
State Saved:	Saved in instrument state.
Range:	-100 to 0.0
Min:	-100.0
Max:	0.0
SCPI Resolution:	0.1
Notes:	This parameter can only set front panel using “Limits” key if the device selected by “Device” key is BTS and “Test Condition” is Normal.
RPG:	0.1

Step: 1.0  
Soft Key Label: I/Q Origin Offset  
Example: :CALC:EEVM:LIM:BTS:NORM:IQOO -12

### EDGE EVM–Peak EVM Limit (Radio Type is BTS, Test Condition is Normal)

**:CALCulate:EEVM:LIMit:BTS:NORMal:PEVM <real>**  
**:CALCulate:EEVM:LIMit:BTS:NORMal:PEVM?**

Mode: GSM  
Key Path: **Meas Setup, Limit**  
Active Function: Peak EVM  
Text:  
Default Terminator: percent  
Factory Preset: 22.0 percent  
State Saved: Saved in instrument state.  
Range: 0.0 to 100.0  
Min: 0.0  
Max: 100.0  
SCPI Resolution: 0.1  
Notes: This parameter can only set front panel using “Limits” key if the device selected by “Device” key is BTS and “Test Condition” is Normal.  
RPG: 0.1  
Step: 1.0  
Soft Key Label: Peak EVM  
Example: :CALC:EEVM:LIM:BTS:NORM:PEVM 12

### EDGE EVM–RMS EVM Limit (Radio Type is BTS, Test Condition is Normal)

**:CALCulate:EEVM:LIMit:BTS:NORMal:REVM <real>**  
**:CALCulate:EEVM:LIMit:BTS:NORMal:REVM?**



Mode: GSM

Key Path: **Meas Setup, Limit**

Active Function Text: RMS EVM

Default Terminator: percent

Factory Preset: 7.0 percent

State Saved: Saved in instrument state.

Range: 0.0 to 100.0

Min: 0.0

Max: 100.0

SCPI Resolution: 0.1

Notes: This parameter can only set front panel using “Limits” key if the device selected by “Device” key is BTS and “Test Condition” is Normal.

Step: 1.0

Soft Key Label: RMS EVM

Example: :CALC:EEVM:LIM:BTS:NORM:REVM 12

**EDGE EVM- 95% tile EVM Limit MS Extreme**

**:CALCulate:EEVM:LIMit:MS:EXTReme:EVMP95 <real>**

**:CALCulate:EEVM:LIMit:MS:EXTReme:EVMP95?**

Name: 95% tile EVM Limit MS Extreme

Key Path: **Meas Setup, Limit**

Active Function Text: 95% tile EVM

Default Terminator: percent

Factory Preset: 15.0 percent

State Saved: Saved in instrument state.

Range: 0.0 to 100.0 percent

SCPI Resolution: 0.1

Notes: This parameter can only be set via front panel using “Limits” key if the device selected by “Device” key is MS and “Test Condition” is Extreme.

Example: :CALC:EEVM:LIM:MS:EXTR:EVMP95 15

### EDGE EVM- Frequency Error Limit MS Extreme

**:CALCulate:EEVM:LIMit:MS:EXTReme:FERRor <real>**

**:CALCulate:EEVM:LIMit:MS:EXTReme:FERRor?**

Name: Frequency Error Limit MS Extreme

Key Path: **Meas Setup, Limit**

Active Function Text: Frequency Error

Default Terminator: Ppm

Factory Preset: 0.1 Ppm

State Saved: Saved in instrument state.

Range: 0.0 to 50.0 Ppm

SCPI Resolution: 0.01

Notes: This parameter can only be set via front panel using “Limits” key if the device selected by “Device” key is MS and “Test Condition” is Extreme.

Example: :CALC:EEVM:LIM:MS:EXTR:FERR 0.2

### EDGE EVM- Frequency Error Limit Micro BTS Extreme

**:CALCulate:EEVM:LIMit:MBTS:EXTReme:FERRor <real>**

**:CALCulate:EEVM:LIMit:MBTS:EXTReme:FERRor?**

Name: Frequency Error Limit Micro BTS Extreme

Key Path: **Meas Setup, Limit**

Active Function Text: Frequency Error

Default Terminator: ppm

Factory Preset: 0.05 ppm  
 State Saved: Saved in instrument state.  
 Range: 0.0 to 50.0 ppm  
 SCPI Resolution: 0.01  
 Notes: This parameter can only be set via front panel using “Limits” key if the device selected by “Device” key is BTS and “BTS Type” is Normal or Micro and “Test Condition” is Extreme.  
 Example: :CALC:EEVM:LIM:BTS:EXTR:FERR 0.1

### EDGE EVM- Frequency Error Limit Micro BTS Normal

```
:CALCulate:EEVM:LIMit:MBTS:NORMal:FERRor <real>  

:CALCulate:EEVM:LIMit:MBTS:NORMal:FERRor?
```

Name: Frequency Error Limit Micro BTS Normal  
 Key Path: **Meas Setup, Limit**  
 Active Function Text: Frequency Error  
 Default Terminator: ppm  
 Factory Preset: 0.05 ppm  
 State Saved: Saved in instrument state.  
 Range: 0 to 50.0 ppm  
 SCPI Resolution: 0.01  
 Notes: This parameter can only be set via front panel using “Limits” key if the device selected by “Device” key is BTS and “BTS Type” is Normal or Micro and “Test Condition” is Normal.  
 Example: :CALC:EEVM:LIM:BTS:NORM:FERR 0.1

### EDGE EVM- I/Q Origin Offset Limit MS Extreme

```
:CALCulate:EEVM:LIMit:MS:EXTReMe:IQOOffset <real>  

:CALCulate:EEVM:LIMit:MS:EXTReMe:IQOOffset?
```

Name: I/Q Origin Offset Limit MS Extreme

Key Path:	<b>Meas Setup, Limit</b>
Active Function Text:	I/Q Origin Offset
Default Terminator:	dBc
Factory Preset:	-30.0 dBc
State Saved:	Saved in instrument state.
Range:	-100.0 to 0.0 dBc
SCPI Resolution:	0.1
Notes:	This parameter can only be set via front panel using “Limits” key if the device selected by “Device” key is MS and “Test Condition” is Extreme.
Example:	:CALC:EEVM:LIM:MS:EXTR:IQOO -15

### EDGE EVM- Peak EVM Limit MS Extreme

**:CALCulate:EEVM:LIMit:MS:EXTReme:PEVM <real>**

**:CALCulate:EEVM:LIMit:MS:EXTReme:PEVM?**

Name:	Peak EVM Limit MS Extreme
Key Path:	<b>Meas Setup, Limit</b>
Active Function Text:	Peak EVM
Default Terminator:	percent
Factory Preset:	30.0 percent
State Saved:	Saved in instrument state.
Range:	0.0 to 100.0 percent
SCPI Resolution:	0.1
Notes:	This parameter can only be set via front panel using “Limits” key if the device selected by “Device” key is MS and “Test Condition” is Extreme.
Example:	:CALC:EEVM:LIM:MS:EXTR:PEVM 15

### EDGE EVM- RMS EVM Limit MS Extreme

```
:CALCulate:EEVM:LIMit:MS:EXTReme:REVM <real>  
:CALCulate:EEVM:LIMit:MS:EXTReme:REVM?
```

Name:	RMS EVM Limit MS Extreme
Key Path:	<b>Meas Setup, Limit</b>
Active Function Text:	RMS EVM
Default Terminator:	percent
Factory Preset:	10.0 percent
State Saved:	Saved in instrument state.
Range:	0.0 to 100.0 percent
SCPI Resolution:	0.1
Notes:	This parameter can only be set via front panel using “Limits” key if the device selected by “Device” key is MS and “Test Condition” is Extreme.
Example:	:CALC:EEVM:LIM:MS:EXTR:REVM 15

### EDGE EVM- 95% tile EVM Limit MS Normal

```
:CALCulate:EEVM:LIMit:MS:NORMal:EVMP95 <real>  
:CALCulate:EEVM:LIMit:MS:NORMal:EVMP95?
```

Name:	95% tile EVM Limit MS Normal
Key Path:	<b>Meas Setup, Limit</b>
Active Function Text:	95% tile EVM
Default Terminator:	percent
Factory Preset:	15.0 percent
State Saved:	Saved in instrument state.
Range:	0.0 to 100.0 percent
SCPI Resolution:	0.1

Notes: This parameter can only be set via front panel using “Limits” key if the device selected by “Device” key is MS and “Test Condition” is Normal.

Example: :CALC:EEVM:LIM:MS:NORM:EVMP95 20

### EDGE EVM- Frequency Error Limit MS Normal

**:CALCulate:EEVM:LIMit:MS:NORMal:FERRor <real>**

**:CALCulate:EEVM:LIMit:MS:NORMal:FERRor?**

Name: Frequency Error Limit MS Normal

Key Path: **Meas Setup, Limit**

Active Function: Frequency Error  
Text:

Default: ppm  
Terminator:

Factory Preset: 0.1 ppm

State Saved: Saved in instrument state.

Range: 0 to 50.0 ppm

SCPI Resolution: 0.01

Notes: This parameter can only be set via front panel using “Limits” key if the device selected by “Device” key is MS and “Test Condition” is Normal.

Example: :CALC:EEVM:LIM:MS:NORM:FERR 0.1

### EDGE EVM- I/Q Origin Offset Limit MS Normal

**:CALCulate:EEVM:LIMit:MS:NORMal:IQOOffset <real>**

**:CALCulate:EEVM:LIMit:MS:NORMal:IQOOffset?**

Name: I/Q Origin Offset Limit MS Normal

Key Path: **Meas Setup, Limit**

Active Function: I/Q Origin Offset  
Text:

Default: dBc  
Terminator:

Factory Preset: -30.0 dBc  
 State Saved: Saved in instrument state.  
 Range: -100.0 to 0.0 dBc  
 SCPI Resolution: 0.1  
 Notes: This parameter can only be set via front panel using “Limits” key if the device selected by “Device” key is MS and “Test Condition” is Normal.  
 Example: :CALC:EEVM:LIM:MS:NORM:IQOO -20

### EDGE EVM- Peak EVM Limit MS Normal

```
:CALCulate:EEVM:LIMit:MS:NORMal:PEVM <real>  

:CALCulate:EEVM:LIMit:MS:NORMal:PEVM?
```

Name: Peak EVM Limit MS Normal  
 Key Path: **Meas Setup, Limit**  
 Active Function Text: Peak EVM  
 Default Terminator: percent  
 Factory Preset: 30.0 percent  
 State Saved: Saved in instrument state.  
 Range: 0.0 to 100.0 percent  
 SCPI Resolution: 0.1  
 Notes: This parameter can only be set via front panel using “Limits” key if the device selected by “Device” key is MS and “Test Condition” is Normal.  
 Example: :CALC:EEVM:LIM:MS:NORM:PEVM 20

### EDGE EVM- RMS EVM Limit MS Normal

```
:CALCulate:EEVM:LIMit:MS:NORMal:REVM <real>  

:CALCulate:EEVM:LIMit:MS:NORMal:REVM?
```

Name: RMS EVM Limit MS Normal

Key Path:	<b>Meas Setup, Limit</b>
Active Function Text:	RMS EVM
Default Terminator:	percent
Factory Preset:	9.0 percent
State Saved:	Saved in instrument state.
Range:	0.0 to 100.0 percent
SCPI Resolution:	0.1
Notes:	This parameter can only be set via front panel using “Limits” key if the device selected by “Device” key is MS and “Test Condition” is Normal.
Example:	:CALC:EEVM:LIM:MS:NORM:REVM 20

### EDGE EVM- Frequency Error Limit Pico BTS Extreme

**:CALCulate:EEVM:LIMit:PBTS:EXTReMe:FERRor <real>**

**:CALCulate:EEVM:LIMit:PBTS:EXTReMe:FERRor?**

Name:	Frequency Error Limit Pico BTS Extreme
Key Path:	<b>Meas Setup, Limit</b>
Active Function Text:	Frequency Error
Default Terminator:	Ppm
Factory Preset:	0.1 Ppm
State Saved:	Saved in instrument state.
Range:	0.0 to 50.0 Ppm
SCPI Resolution:	0.01
Notes:	This parameter can only be set via front panel using “Limits” key if the device selected by “Device” key is BTS and “BTS Type” is Pico and “Test Condition” is Extreme.
Example:	:CALC:EEVM:LIM:PBTS:EXTR:FERR 0.2



## EDGE EVM- Frequency Error Limit Pico BTS Normal

**:CALCulate:EEVM:LIMit:PBTS:NORMal:FERRor <real>**

**:CALCulate:EEVM:LIMit:PBTS:NORMal:FERRor?**

Name:	Frequency Error Limit Pico BTS Normal
Key Path:	<b>Meas Setup, Limit</b>
Active Function Text:	Frequency Error
Default Terminator:	ppm
Factory Preset:	0.1 ppm
State Saved:	Saved in instrument state.
Range:	0 to 50.0 ppm
SCPI Resolution:	0.01
Notes:	This parameter can only be set via front panel using “Limits” key if the device selected by “Device” key is BTS and “BTS Type” is Pico and “Test Condition” is Normal.
Example:	:CALC:EEVM:LIM:PBTS:NORM:FERR 0.1

## EDGE TX Band Spur Calculate Commands

### EDGE Transmit Band Spurs—Type of Limit Testing

**:CALCulate:ETSPur:LIMit:TEST ABSolute|RELative**

**:CALCulate:ETSPur:LIMit:TEST?**

Select the limit testing to be done using either absolute (dBm) or relative power (dB) limits.

Factory Preset: Absolute

Remarks: You must be in the EDGE (w/GSM) mode to use this command. Use INSTRument:SElect to set the mode.

History: For E4406A:  
Version A.05.00 or later

Front Panel

Access: **Meas Setup, More, Limit**

### EDGE Transmit Band Spurs—Define Limits

**:CALCulate:ETSPur:LIMit[:UPPer][:DATA] <power>**

**:CALCulate:ETSPur:LIMit[:UPPer][:DATA]?**

Set the value for the test limit. This command does not accept units. Use CALCulate:ETSPur:LIMit:TEST to select the units dBm (absolute) or dB (relative).

Factory Preset: -36

Range: -200 to 100

Remarks: You must be in the EDGE (w/GSM) mode to use this command. Use INSTRument:SElect to set the mode.

History: For E4406A:  
Version A.05.00 or later

Front Panel

Access: **Meas Setup, More, Limit**

## CALCulate:MARKers Subsystem

Markers can be put on your displayed measurement data to supply information about specific points on the data. Some of the things that markers can be used to measure include: precise frequency at a point, minimum or maximum amplitude, and the difference in amplitude or frequency between two points.

When using the marker commands you must specify the measurement in the SCPI command. We recommend that you use the marker commands only on the current measurement. Many marker commands will return invalid results, when used on a measurement that is not current. (This is true for commands that do more than simply setting or querying an instrument parameter.) No error is reported for these invalid results.

You must make sure that the measurement is completed before trying to query the marker value. Using the MEASure or READ command, before the marker command, forces the measurement to complete before allowing the next command to be executed.

Each measurement has its own instrument state for marker parameters. Therefore, if you exit the measurement, the marker settings in each measurement are saved and are then recalled when you change back to that measurement.

### Basic Mode - <measurement> key words

- ACPr - no markers (E4406A only)
- CHPower - no markers (E4406A only)
- PStatistic - markers available (E4406A only)
- SPECTrum - markers available
- WAVeform - markers available

### Service Mode - <measurement> key words

- PVTime - no markers
- SPECTrum - markers available
- WAVeform - markers available

### 1xEV-DO Mode - <measurement> key words

- CDPower - markers available
- CHPower - no markers
- EVMQpsk - markers available
- IM - markers available
- OBW - no markers
- PStatistic - markers available
- PVTime - markers available
- RHO - markers available
- SEMask - markers available
- SPECTrum - markers available

- WAVEform - markers available

**cdmaOne Mode - <measurement> key words**

- ACPr - no markers
- CHPower - no markers
- CDPower - markers available
- CSPur - markers available
- RHO - markers available
- SPECTrum - markers available
- WAVEform - markers available

**cdma2000 Mode - <measurement> key words**

- ACP - no markers
- CDPower - markers available
- CHPower - no markers
- EVMQpsk - markers available
- IM - markers available
- OBW - no markers
- PStatistic - markers available
- RHO - markers available
- SEMask - markers available
- SPECTrum - markers available
- WAVEform - markers available

**GSM (with EDGE) Mode - <measurement> key words**

- EEVM - markers available
- EORFspectr - markers available
- EPVTime - no markers
- ETSPur - markers available
- ORFSpectrum - markers available
- PFERror - markers available
- PVTime - no markers
- SPECTrum - markers available
- TSPur - markers available
- TXPower - no markers
- WAVEform - markers available

**GSM Mode - <measurement> key words**

- ORFSpectrum - markers available
- PFERror - markers available
- PVTime - no markers
- SPECTrum - markers available
- TSPur - markers available
- TXPower - no markers
- WAVEform - markers available

### **iDEN Mode - <measurement> key words**

- ACP - no markers
- BER - no markers
- OBW - no markers
- SPECTrum - markers available
- WAVeform - markers available

### **NADC Mode - <measurement> key words**

- ACP - no markers
- EVM - markers available
- SPECTrum - markers available
- WAVeform - markers available

### **PDC Mode - <measurement> key words**

- ACP - no markers
- EVM - markers available
- OBW - no markers
- SPECTrum - markers available
- WAVeform - markers available

### **W-CDMA Mode - <measurement> key words**

- ACP - no markers
- CDPower - markers available
- CHPower - no markers
- EVMQpsk - markers available
- IM - markers available
- MCPower - no markers
- OBW - no markers
- PStatistic - markers available
- PCONtrol - markers available
- PStatistic - markers available
- PVTmask - markers available
- SEMask - markers available
- SPECTrum - markers available
- WAVeform - markers available

### **MARKer SCPI Example:**

Suppose you are using the Spectrum measurement in your measurement personality. To position marker 2 at the maximum peak value of the trace that marker 2 is currently on, the command is:

```
:CALCulate:SPECTrum:MARKer2:MAXimum
```

You must make sure that the measurement is completed before trying to query the marker value. Use the MEASure or READ command before using the marker command. This forces the measurement to complete before allowing the next command to be executed.

### Markers All Off on All Traces

**:CALCulate:<measurement>:MARKer:AOff**

Turns off all markers on all the traces in the specified measurement.

Example: **CALC:SPEC:MARK:AOff**

Remarks: The keyword for the current measurement must be specified in the command. (Some examples include: SPECTrum, WAVeform)

Front Panel

Access: **Marker, More, Marker All Off**

### Marker Function Result

**:CALCulate:<measurement>:MARKer[1] | 2 | 3 | 4:FUNCTION:RESult?**

Queries the result of the currently active marker function. The measurement must be completed before querying the marker. A particular measurement may not have all the types of markers available.

The marker must have already been assigned to a trace. Use

**:CALCulate:<measurement>:MARKer[1] | 2 | 3 | 4:TRACe** to assign a marker to a particular trace.

Example: **CALC:SPEC:MARK:FUNC:RES?**

Remarks: The keyword for the current measurement must be specified in the command. (Some examples include: SPECTrum, WAVeform)

Front Panel

Access: **Marker, Marker Function**

### Marker Peak (Maximum) Search

**:CALCulate:<measurement>:MARKer[1] | 2 | 3 | 4:MAXimum**

Places the selected marker on the highest point on the trace that is assigned to that particular marker number.

The marker must have already been assigned to a trace. Use

**:CALCulate:<measurement>:MARKer[1] | 2 | 3 | 4:TRACe** to assign a marker to a particular trace.

Example: **CALC:SPEC:MARK1:MAX**

Remarks: The keyword for the current measurement must be

specified in the command. (Some examples include: SPECTrum, WAVeform)

Front Panel  
Access: **Search**

### Marker Peak (Minimum) Search

**:CALCulate:<measurement>:MARKer [1] | 2 | 3 | 4:MINimum**

Places the selected marker on the lowest point on the trace that is assigned to that particular marker number.

The marker must have already been assigned to a trace. Use **:CALCulate:<measurement>:MARKer [1] | 2 | 3 | 4:TRACe** to assign a marker to a particular trace.

Example: **CALC:SPEC:MARK2 MIN**

Remarks: The keyword for the current measurement must be specified in the command. (Some examples include: SPECTrum, WAVeform)

### Marker Mode

*E4406A (all modes):*

*PSA Series (Basic, cdmaOne, cdma2000, W-CDMA, GSM/EDGE, NADC, PDC modes):*

**:CALCulate:<measurement>:MARKer [1] | 2 | 3 | 4:MODE  
POSition|DELTA**

*ESA/PSA Series (Phase Noise mode only):*

**:CALCulate:<measurement>:MARKer [1] | 2 | 3 | 4:MODE  
POSition|DELTA|RMSDegree  
|RMSRadian|RFM|RMSJitter|OFF**

**:CALCulate:<measurement>:MARKer [1] | 2 | 3 | 4:MODE?**

E4406A/PSA: Selects the type of marker to be a normal position-type marker or a delta marker. A specific measurement may not have both types of markers. For example, several measurements only have position markers

ESA/PSA Phase Noise Mode: Selects the type of marker to be a normal position-type marker, a delta marker or an RMS measurement marker.

The marker must have already been assigned to a trace. Use **:CALCulate:<measurement>:MARKer [1] | 2 | 3 | 4:TRACe** to assign a marker to a particular trace.

Example: **CALC:SPEC:MARK:MODE DELTA**

Remarks: For the delta mode only markers 1 and 2 are valid.  
The keyword for the current measurement must be specified in the command. (Some examples include: SPECTrum, WAVeform)

Front Panel  
Access: **Marker, Marker [Delta]**

### Marker On/Off

```
:CALCulate:<measurement>:MARKer [1] | 2 | 3 | 4 [:STATe] OFF | ON | 0 | 1  
:CALCulate:<measurement>:MARKer [1] | 2 | 3 | 4 [:STATe] ?
```

Turns the selected marker on or off.

The marker must have already been assigned to a trace. Use  
**:CALCulate:<measurement>:MARKer [1] | 2 | 3 | 4 :TRACe** to assign a marker to a particular trace.

Example: **CALC:SPEC:MARK2: on**

Remarks: The keyword for the current measurement must be specified in the command. (Some examples include: SPECTrum, AREFERENCE, CFLOCATION, WAVeform)  
The WAVeform measurement only has two markers available.

Front Panel  
Access: **Marker, Select then Marker Normal or Marker On Off**

### Marker to Trace

```
:CALCulate:<measurement>:MARKer [1] | 2 | 3 | 4 :TRACe <trace_name>  
:CALCulate:<measurement>:MARKer [1] | 2 | 3 | 4 :TRACe ?
```

Assigns the specified marker to the designated trace. Not all types of measurement data can have markers assigned to them.

Example: With the WAVeform measurement selected, a valid command is **CALC:SPEC:MARK2:TRACE rfenvelope**.

Range: The names of valid traces are dependent upon the selected measurement. See the following table for the available trace names. The trace name assignment is independent of the marker number.

Remarks: The keyword for the current measurement must be specified in the command. (Some examples include:



SPECTrum, WAVeform)

Front Panel

Access: **Marker, Marker Trace**

Measurement	Available Traces	Markers Available?
ACP - adjacent channel power (Basic, cdmaOne, cdma2000, W-CDMA, iDEN (E4406A only), WiDEN (E4406A only), NADC, PDC modes)	no traces $(n=0)^a$ for I/Q points	no markers
BER - bit error rate (iDEN, WiDEN mode, E4406A only)	no traces $(n=0)^a$ for I/Q data	no markers
CDPower - code domain power (cdmaOne mode)	POWER $(n=2)^a$ TIMing $(n=3)^a$ PHASe $(n=4)^a$ $(n=0)^a$ for I/Q points	yes
CDPower - code domain power (cdma2000, W-CDMA, 1xEV-DO modes)	CDPower $(n=2)^a$ EVM $(n=5)^a$ MERRor $(n=6)^a$ PERRor $(n=7)^a$ SPOWer $(n=9)^a$ CPOWer $(n=10)^a$ $(n=0)^a$ for I/Q points	yes
CHPower - channel power (Basic, cdmaOne, cdma2000, W-CDMA, 1xEV-DO modes)	SPECTrum $(n=2)^a$ $(n=0)^a$ for I/Q points	no markers
CSPur - spurs close (cdmaOne mode)	SPECTrum $(n=2)^a$ ULIMit $(n=3)^a$ $(n=0)^a$ for I/Q points	yes
EEVM - EDGE error vector magnitude (EDGE mode)	EVMerror $(n=2)^a$ MERRor $(n=3)^a$ PERRor $(n=4)^a$ $(n=0)^a$ for I/Q points	yes

Measurement	Available Traces	Markers Available?
EORFspectr - EDGE output RF spectrum (EDGE mode)	RFEMod ( $n=2$ ) <sup>a</sup> RFESwitching ( $n=3$ ) <sup>a</sup> SPEMod ( $n=4$ ) <sup>a</sup> LIMMod ( $n=5$ ) <sup>a</sup> ( $n=0$ ) <sup>a</sup> for I/Q points	yes, only for a single offset  yes, only for multiple offsets
EPVTime - EDGE power versus time (EDGE mode)	RFENvelope ( $n=2$ ) <sup>a</sup> UMASk ( $n=3$ ) <sup>a</sup> LMASk ( $n=4$ ) <sup>a</sup> ( $n=0$ ) <sup>a</sup> for I/Q points	yes
ETSPur - EDGE transmit band spurs (EDGE mode)	SPECtrum ( $n=2$ ) <sup>a</sup> ULIMit ( $n=3$ ) <sup>a</sup> ( $n=0$ ) <sup>a</sup> for I/Q points	yes
EVM - error vector magnitude (NADC, PDC modes)	EVM ( $n=2$ ) <sup>a</sup> MERRor ( $n=3$ ) <sup>a</sup> PERRor ( $n=4$ ) <sup>a</sup> ( $n=0$ ) <sup>a</sup> for I/Q points	yes
EVMQpsk - QPSK error vector magnitude (cdma2000, W-CDMA, 1xEV-DO modes)	EVM ( $n=2$ ) <sup>a</sup> MERRor ( $n=3$ ) <sup>a</sup> PERRor ( $n=4$ ) <sup>a</sup> ( $n=0$ ) <sup>a</sup> for I/Q points	yes
IM - intermodulation (cdma2000, W-CDMA, 1xEV-DO modes)	SPECtrum ( $n=2$ ) <sup>a</sup> ( $n=0$ ) <sup>a</sup> for I/Q points	yes
MCPower - multi-carrier power (W-CDMA mode)	no traces ( $n=0$ ) <sup>a</sup> for I/Q points	no markers
OBW - occupied bandwidth (cdmaOne, cdma2000, iDEN (E4406A only), WiDEN (E4406A only), PDC, W-CDMA, 1xEV-DO modes)	no traces ( $n=0$ ) <sup>a</sup> for I/Q points	no markers

Measurement	Available Traces	Markers Available?
ORFSpectrum - output RF spectrum (GSM, EDGE mode)	RFEMod ( $n=2$ ) <sup>a</sup> RFESwitching ( $n=3$ ) <sup>a</sup> SPEMod ( $n=4$ ) <sup>a</sup> LIMMod ( $n=5$ ) <sup>a</sup> ( $n=0$ ) <sup>a</sup> for I/Q points	yes, only for a single offset  yes, only for multiple offsets
PFERror - phase and frequency error (GSM, EDGE mode)	PERRor ( $n=2$ ) <sup>a</sup> PFERror ( $n=3$ ) <sup>a</sup> RFENvelope ( $n=4$ ) <sup>a</sup> ( $n=0$ ) <sup>a</sup> for I/Q points	yes
PStatistic - power statistics CCDF (Basic, cdma2000, W-CDMA, 1xEV-DO modes)	MEASured ( $n=2$ ) <sup>a</sup> GAUSSian ( $n=3$ ) <sup>a</sup> REFerence ( $n=4$ ) <sup>a</sup> ( $n=0$ ) <sup>a</sup> for I/Q points	yes
PVTime - power versus time (GSM, EDGE, 1xEV-DO, Service (E4406A only) modes)	RFENvelope ( $n=2$ ) <sup>a</sup> UMASk ( $n=3$ ) <sup>a</sup> LMASk ( $n=4$ ) <sup>a</sup> ( $n=0$ ) <sup>a</sup> for I/Q points	yes
RHO - modulation quality (cdmaOne, cdma2000, W-CDMA, 1xEV-DO mode)	( $n=0$ ) <sup>a</sup> for I/Q points EVM ( $n=2$ ) <sup>a</sup> MERRor ( $n=3$ ) <sup>a</sup> PERRor ( $n=4$ ) <sup>a</sup> ( $n=0$ ) <sup>a</sup> for I/Q points	yes
SEMask - spectrum emissions mask (cdma2000, W-CDMA, 1xEV-DO mode)	SPECTrum ( $n=2$ ) <sup>a</sup> ( $n=0$ ) <sup>a</sup> for I/Q points	yes
TSPur - transmit band spurs (GSM, EDGE mode)	SPECTrum ( $n=2$ ) <sup>a</sup> ULIMit ( $n=3$ ) <sup>a</sup> ( $n=0$ ) <sup>a</sup> for I/Q points	yes

Measurement	Available Traces	Markers Available?
TXPower - transmit power (GSM, EDGE mode)	RFENvelope ( $n=2$ ) <sup>a</sup> IQ ( $n=8$ ) <sup>a</sup> ( $n=0$ ) <sup>a</sup> for I/Q points	yes
SPECtrum - (frequency domain) (all modes)	RFENvelope ( $n=2$ ) <sup>a</sup> for Service mode (E4406A only) IQ ( $n=3$ ) <sup>a</sup> SPECtrum ( $n=4$ ) <sup>a</sup> ASpectrum ( $n=7$ ) <sup>a</sup> ( $n=0$ ) <sup>a</sup> for I/Q points	yes
WAVEform - (time domain) (all modes)	RFENvelope ( $n=2$ ) <sup>a</sup> (also for Signal Envelope trace) IQ ( $n=5$ ) <sup>a</sup> ( $n=0$ ) <sup>a</sup> for I/Q points	yes

a. The  $n$  number indicates the sub-opcode that corresponds to this trace. Detailed descriptions of the trace data can be found in the MEASure subsystem documentation by looking up the sub-opcode for the appropriate measurement.

### Marker X Value

**:CALCulate:<measurement>:MARKer [1] | 2 | 3 | 4 :X <param>**

**:CALCulate:<measurement>:MARKer [1] | 2 | 3 | 4 :X?**

Position the designated marker on its assigned trace at the specified X value. The parameter value is in X-axis units (which is often frequency or time).

The marker must have already been assigned to a trace. Use **:CALCulate:<measurement>:MARKer [1] | 2 | 3 | 4 :TRACe** to assign a marker to a particular trace.

The query returns the current X value of the designated marker. The measurement must be completed before querying the marker.

Example: **CALC:SPEC:MARK2:X 1.2e6 Hz**

Range: For Phase Noise mode: Graph Start Offset and Stop

Offset frequencies.

Default Unit: Matches the units of the trace on which the marker is positioned

Remarks: The keyword for the current measurement must be specified in the command. (Some examples include: LPLot, ACP, CFLocation, WAVEform)

Front Panel

Access: **Marker, <active marker>, RPG**

### Marker X Position

**:CALCulate:<measurement>:MARKer[1] | 2 | 3 | 4:X:POSition <integer>**

**:CALCulate:<measurement>:MARKer[1] | 2 | 3 | 4:X:POSition?**

Position the designated marker on its assigned trace at the specified X position. A trace is composed of a variable number of measurement points. This number changes depending on the current measurement conditions. The current number of points must be identified before using this command to place the marker at a specific location.

The marker must have already been assigned to a trace. Use **:CALCulate:<measurement>:MARKer[1] | 2 | 3 | 4:TRACe** to assign a marker to a particular trace.

The query returns the current X position for the designated marker. The measurement must be completed before querying the marker.

Example: **CALC:SPEC:MARK:X:POS 500**

Range: 0 to a maximum of (3 to 920,000)

Remarks: The keyword for the current measurement must be specified in the command. (Some examples include: SPECTrum, WAVEform)

Front Panel

Access: **Marker, <active marker>, RPG**

### Marker Readout Y Value

**:CALCulate:<measurement>:MARKer[1] | 2 | 3 | 4:Y?**

Readout the current Y value for the designated marker on its assigned trace. The value is in the Y-axis units for the trace (which is often dBm).

The marker must have already been assigned to a trace. Use **:CALCulate:<measurement>:MARKer[1] | 2 | 3 | 4:TRACe** to assign a marker to a particular trace.

Programming Commands  
**CALCulate Subsystem**

The measurement must be completed before querying the marker.

Example:       **CALC:SPEC:MARK1:Y?**

Default Unit:   Matches the units of the trace on which the marker is positioned

Remarks:       The keyword for the current measurement must be specified in the command. (Some examples include: LPLot, ACP, CFLocation, WAVEform)

## CALCulate Phase and Frequency Error Subsystem

### Phase and Frequency Error- RMS Phase Error BTS

**:CALCulate:PFER:LIMit:BTS:FERRor <real>**

**:CALCulate:PFER:LIMit:BTS:FERRor?**

Name:	RMS Phase Error BTS
Key Path:	<b>Meas Setup, Limit</b>
Active Function Text:	Freq Error
Default Terminator:	ppm
Factory Preset:	0.05 ppm
State Saved:	Saved in instrument state.
Range:	0.0 to 50.0 ppm
SCPI Resolution:	0.01
Notes:	This parameter can only be set via front panel using “Limits” key if the device selected by “Device” key is BTS and “BTS Type” is Normal or Micro.
Example:	:CALC:PFER:LIM:BTS:FERR 0.1

### Phase and Frequency Error- Peak Phase Error BTS

**:CALCulate:PFER:LIMit:BTS:PPHase <degree>**

**:CALCulate:PFER:LIMit:BTS:PPHase?**

Name:	Peak Phase Error BTS
Key Path:	<b>Meas Setup, Limit</b>
Active Function Text:	Peak Phase Error
Default Terminator:	degree
Factory Preset:	20.0 degree
State Saved:	Saved in instrument state.
Range:	0.0 to 180.0 degree

SCPI Resolution: 0.1

Notes: This parameter can only be set via front panel using “Limits” key if the device selected by “Device” key is BTS.

Example: :CALC:PFER:LIM:BTS:PPH 30

### Phase and Frequency Error- RMS Phase Error BTS

**:CALCulate:PFER:LIMit:BTS:RPHase <degree>**

**:CALCulate:PFER:LIMit:BTS:RPHase?**

Name: RMS Phase Error BTS

Key Path: **Meas Setup, Limit**

Active Function: RMS Phase Error  
Text:

Default Terminator: degree

Factory Preset: 5.0 degree

State Saved: Saved in instrument state.

Range: 0.0 to 180.0 degree

SCPI Resolution: 0.1

Notes: This parameter can only be set via front panel using “Limits” key if the device selected by “Device” key is BTS.

Example: :CALC:PFER:LIM:BTS:RPH 10

### Phase and Frequency Error- RMS Phase Error Micro BTS

**:CALCulate:PFER:LIMit:MBTS:FERRor <real>**

**:CALCulate:PFER:LIMit:MBTS:FERRor?**

Name: RMS Phase Error Micro BTS

Key Path: **Meas Setup, Limit**

Active Function: Freq Error  
Text:



Default Terminator: ppm

Factory Preset: 0.05 ppm

State Saved: Saved in instrument state.

Range: 0.0 to 50.0 ppm

SCPI Resolution: 0.01

Notes: This parameter can only be set via front panel using “Limits” key if the device selected by “Device” key is BTS and “BTS Type” is Normal or Micro.

Example: :CALC:PFER:LIM:MBTS:FERR 0.1

### Phase and Frequency Error- RMS Phase Error MS

**:CALCulate:PFER:LIMit:MS:FERRor <real>**

**:CALCulate:PFER:LIMit:MS:FERRor?**

Name: RMS Phase Error MS

Key Path: **Meas Setup, Limit**

Active Function Text: Freq Error

Default Terminator: ppm

Factory Preset: 0.1 ppm

State Saved: Saved in instrument state.

Range: 0.0 to 50.0 ppm

SCPI Resolution: 0.01

Notes: This parameter can only be set via front panel using “Limits” key if the device selected by “Device” key is MS.

Example: :CALC:PFER:LIM:MS:FERR 0.1

### Phase and Frequency Error- Peak Phase Error MS

**:CALCulate:PFER:LIMit:MS:PPHase <degree>**

**:CALCulate:PFER:LIMit:MS:PPHase?**

Name:	Peak Phase Error MS
Key Path:	<b>Meas Setup, Limit</b>
Active Function Text:	Peak Phase Error
Default Terminator:	degree
Factory Preset:	20.0 degree
State Saved:	Saved in instrument state.
Range:	0.0 to 180.0 degree
SCPI Resolution:	0.1
Notes:	This parameter can only be set via front panel using “Limits” key if the device selected by “Device” key is MS.
Example:	:CALC:PFER:LIM:MS:PPH 10

### Phase and Frequency Error- RMS Phase Error MS

**:CALCulate:PFER:LIMit:MS:RPHase <degree>**  
**:CALCulate:PFER:LIMit:MS:RPHase?**

Name:	RMS Phase Error MS
Key Path:	<b>Meas Setup, Limit</b>
Active Function Text:	RMS Phase Error
Default Terminator:	degree
Factory Preset:	5.0 degree
State Saved:	Saved in instrument state.
Range:	0.0 to 180.0 degree
SCPI Resolution:	0.1
Notes:	This parameter can only be set via front panel using “Limits” key if the device selected by “Device” key is MS.
Example:	:CALC:PFER:LIM:MS:RPH 10

## Phase and Frequency Error- RMS Phase Error Pico BTS

**:CALCulate:PFER:LIMit:PBTS:FERRor <real>**

**:CALCulate:PFER:LIMit:PBTS:FERRor?**

Name:	RMS Phase Error Pico BTS
Key Path:	<b>Meas Setup, Limit</b>
Active Function Text:	Freq Error
Default Terminator:	ppm
Factory Preset:	0.1 ppm
State Saved:	Saved in instrument state.
Range:	0.0 to 50.0 ppm
SCPI Resolution:	0.01
Notes:	This parameter can only be set via front panel using “Limits” key if the device selected by “Device” key is BTS and “BTS Type” is Pico.
Example:	:CALC:PFER:LIM:PBTS:FERR 0.1

## Baseband I/Q - Spectrum I/Q Marker Query

**:CALCulate:SPECTrum:MARKer[1] | 2 | 3 | 4:IQ?**

Reads out current I and Q marker values.

Remarks: You must be in the Basic, W-CDMA, cdma2000, or EDGE with GSM mode to use this command. Use INSTRument:SElect to set the mode.

History: Added revision A.05.00 for B, WC, C2  
Added revision A.06.00 for E

## Transmit Band Spurious - Limits

### Transmit Band Spurs—Type of Limit Testing

**:CALCulate:TSPur:LIMit:TEST ABSolute|RELative**

**:CALCulate:TSPur:LIMit:TEST?**

Select the limit testing to be done using either absolute or relative power limits.

Factory Preset: Absolute

Remarks: You must be in the GSM, EDGE(w/GSM) mode to use this command. Use INSTRument:SElect to set the mode.

History: Version A.03.00 or later

Front Panel

Access: **Meas Setup, Limit**

### Transmit Band Spurs—Define Limits

**:CALCulate:TSPur:LIMit[:UPPer][:DATA] <power>**

**:CALCulate:TSPur:LIMit[:UPPer][:DATA]?**

Set the value for the test limit. This command does not accept units. Use CALCulate:TSPur:LIMit:TEST to select the units dBm (absolute) or dB (relative).

Factory Preset: -36

Range: -200 to 100

Remarks: You must be in the GSM, EDGE (w/GSM) mode to use this command. Use INSTRument:SElect to set the mode.

History: Version A.03.00 or later

Front Panel

Access: **Meas Setup, Limit**

## Baseband I/Q - Waveform I/Q Marker Query

**:CALCulate:WAVEform:MARKer [1] | 2 | 3 | 4 :IQ?**

Reads out current I and Q marker values.

Remarks: You must be in the Basic, W-CDMA, cdma2000, or GSM with EDGE mode to use this command. Use INSTRument:SElect to set the mode.

History: Added revision A.05.00 for B, WC, C2  
Added revision A.06.00 for E

## CONFigure Subsystem

The CONFigure commands are used with several other commands to control the measurement process. The full set of commands are described in the section “[MEASure Group of Commands](#)” on page 332.

Selecting measurements with the CONFigure/FETCh/MEASure/READ commands sets the instrument state to the defaults for that measurement and to make a single measurement. Other commands are available for each measurement to allow you to change: settings, view, limits, etc. Refer to:

```
SENSe:<measurement>, SENSe:CHANnel, SENSe:CORRection,
SENSe:DEFaults, SENSe:DEViation, SENSe:FREQuency,
SENSe:PACKet, SENSe:POWer, SENSe:RADio, SENSe:SYNC
CALCulate:<measurement>, CALCulate:CLIMits
DISPlay:<measurement>
TRIGger
```

The INITiate[:IMMEDIATE] or INITiate:REStart commands will initiate the taking of measurement data without resetting any of the measurement settings that you have changed from their defaults.

### Configure the Selected Measurement

```
:CONFigure: <measurement>
```

A CONFigure command must specify the desired measurement. It will set the instrument settings for that measurement’s standard defaults, but should not initiate the taking of data. The available measurements are described in the MEASure subsystem.

---

**NOTE**

If CONFigure initiates the taking of data, the data should be ignored. Other SCPI commands can be processed immediately after sending CONFigure. You do not need to wait for the CONF command to complete this 'false' data acquisition.

---

### Configure Query

```
:CONFigure?
```

The CONFigure query returns the name of the current measurement.

---

## DISPlay Subsystem

The DISPlay controls the selection and presentation of textual, graphical, and TRACe information. Within a DISPlay, information may be separated into individual WINDows.

### Adjacent Channel Power - View Selection

**:DISPlay:ACP:VIEW BGRaph|SPECTrum**

**:DISPlay:ACP:VIEW?**

Select the adjacent channel power measurement display of bar graph or spectrum.

You may want to disable the spectrum trace data part of the measurement so you can increase the speed of the rest of the measurement display. Use **SENSe:ACP:SPECTrum:ENABLE** to turn on or off the spectrum trace. (Basic and cdmaOne modes only)

Factory Preset: Bar Graph (BGRaph)

Remarks: For E4406A you must be in the Basic, cdmaOne, cdma2000, W-CDMA, NADC or PDC mode to use this command. Use **INSTRument:SElect** to set the mode.

For PSA you must be in the cdmaOne, cdma2000, W-CDMA, NADC or PDC mode to use this command. Use **INSTRument:SElect** to set the mode.

Front Panel

Access: **ACP, View/Trace**

### Turn the Display On/Off

**:DISPlay:ENABLE OFF|ON|0|1**

**:DISPlay:ENABLE?**

Controls the display. If enable is set to off, the display is turned off. For E4406A, if enable is set to off, the display will appear to “freeze” in its current state. Measurements may run faster since the instrument doesn’t have to update the display after every data acquisition. There is often no need to update the display information when using remote operation. Turning the display off will also extend its life and reduce EMI. An instrument preset will turn the display back on.

Factory Preset: On



Remarks: The following key presses will turn display enable back on:

1. If in local, press any key
2. If in remote, press the local (system) key
3. If in local lockout (SYST:KLOCK), no key press will work

Front Panel  
Access

(for E4406A): **System, Disp Updates**

## EDGE PVT - Limit Mask On/Off

**:DISPlay:EPVTime:LIMit:MASK OFF|ON|0|1**

**:DISPlay:EPVTime:LIMit:MASK?**

Turns on/off the display of the limit mask lines. It also disables the limit checking.

Factory Preset: On

Remarks: You must be in EDGE (w/GSM) to use this command.  
Use INSTRument:SElect to set the mode.

Front Panel

Access: **Display**, with EPVT measurement selected

## Select Display Format

**:DISPlay:FORMat:TILE**

Selects the viewing format that displays multiple windows of the current measurement data simultaneously. Use DISP:FORM:ZOOM to return the display to a single window.

Remarks: For PSA you must be in the Basic, cdmaOne,cdma2000, 1xEV-DO, W-CDMA, GSM (w/EDGE), NADC, or PDC mode to use this command. Use INSTRument:SElect to set the mode

Front Panel

Access: **Zoom** (toggles between Tile and Zoom)

## Select Display Format

**:DISPlay:FORMat:ZOOM**

Selects the viewing format that displays only one window of the current measurement data (the current active window). Use DISP:FORM:TILE to return the display to multiple windows.

Remarks: For PSA you must be in the Basic, cdmaOne,cdma2000, 1xEV-DO, W-CDMA, GSM (w/EDGE), NADC, or PDC mode to use this command. Use INSTRUMENT:SElect to set the mode

Front Panel

Access: **Zoom** (toggles between Tile and Zoom)

## Full Screen Display (PSA Only)

**:DISPlay:FSCreen[:STATE] OFF|ON|0|1**

**:DISPlay:FSCreen[:STATE]?**

For Noise Figure Mode only:

**:DISPlay:FSCREEN|FULLSCREEN[:STATE] ON|OFF|1|0**

**:DISPlay:FSCREEN|FULLSCREEN[:STATE]?**

When the full screen function is activated, the measurement window expands horizontally over the entire instrument display. That is, it turns off the display of the softkey labels. Pressing any other key that results in a new menu will cancel the full screen function.

State Saved: Not saved in state.

Factory Preset: Off

Factory

Default: Off

Front Panel

Access: **Display**

Example: DISP:FSCR ON

History: PSA: Added with firmware revision A.02.00

## PVT - Limit Mask Display

**:DISPlay:PVTTime:LIMit:MASK OFF|ON|0|1**

**:DISPlay:PVTTime:LIMit:MASK?**

Turns on/off the display function of the limit mask lines. It also controls the limit checking function.

See also [:SENS]:PVT:LIM:MASK.

Factory Preset: ON

Remarks: You must be in GSM, EDGE, 1xEV-DO or W-CDMA mode to use this command. Use INSTRUMENT:SElect to set the mode.

Front Panel

Access: **Power vs Time, Display**

## Spectrum - Y-Axis Scale/Div

```
:DISPlay:SPECTrum[n]:WINDow[m]:TRACe:Y[:SCALE]:PDIVision  
<power>
```

```
:DISPlay:SPECTrum[n]:WINDow[m]:TRACe:Y[:SCALE]:PDIVision?
```

Sets the scale per division for the y-axis.

n – selects the view, the default is Spectrum.

m – selects the window within the view. The default is 1.

— n=1, m=1 Spectrum

— n=1, m=2 I/Q Waveform

— n=1, m=2 I and Q Waveform (Basic, W-CDMA, cdma2000)

— n=1, m=3 numeric data (Service mode, E4406A only)

— n=1, m=4 RF envelope (Service mode, E4406A only)

— n=2, m=1 I Waveform (Option B7C, E4406A only)

— n=2, m=2 Q Waveform (Option B7C, E4406A only)

— n=3, m=1 I/Q Polar (Basic, W-CDMA, cdma2000)

— n=4, m=1 Linear Spectrum (Basic, W-CDMA, cdma2000)

Factory Preset: 10 dB per division, for Spectrum

100 mV per division, for I/Q Waveform

Range: 0.1 dB to 20 dB per division, for Spectrum

1 nV to 20 V per division, for I/Q Waveform

Default Unit: 10 dB per division, for Spectrum

Remarks: May affect input attenuator setting.

For E4406A to use this command, the appropriate mode should be selected with INSTRUMENT:SElect.

For PSA you must be in Basic, cdmaOne, cdma2000, 1xEV-DO, W-CDMA GSM w/EDGE, NADC, or PDC mode. Set the mode with INSTRUMENT:SElect.

Front Panel

Access: When in Spectrum measurement: **Amplitude Y Scale, Scale/Div.**

History: For PSA:  
Added revision A.02.00  
For E4406A:  
Modified revision A.05.00

## Spectrum - Y-Axis Reference Level

```
:DISPlay:SPECTrum[n] :WINDow[m] :TRACe:Y[:SCALE] :RLEVel  
<power>
```

```
:DISPlay:SPECTrum[n] :WINDow[m] :TRACe:Y[:SCALE] :RLEVel?
```

Sets the amplitude reference level for the y-axis.

n, selects the view, the default is RF envelope.

- n=1, m=1 Spectrum
- n=1, m=2 I/Q Waveform
- n=1, m=2 I and Q Waveform (Basic, W-CDMA, cdma2000)
- n=1, m=3 numeric data (Service mode, E4406A only)
- n=1, m=4 RF envelope (Service mode, E4406A only)
- n=2, m=1 I Waveform (Option B7C, E4406A only)
- n=2, m=2 Q Waveform (Option B7C, E4406A only)
- n=3, m=1 I/Q Polar (Basic, W-CDMA, cdma2000)
- n=4, m=1 Linear Spectrum (Basic, W-CDMA, cdma2000)

m – selects the window within the view. The default is 1.

Factory Preset: 0 dBm, for Spectrum

Range: -250 to 250 dBm, for Spectrum

Default Unit: dBm, for Spectrum

Remarks: May affect input attenuator setting.

For E4406A to use this command, the appropriate mode should be selected with INSTRUMENT:SElect.

For PSA you must be in Basic, cdmaOne, cdma2000, 1xEV-DO, W-CDMA GSM w/EDGE, NADC, or PDC mode. Set the mode with INSTRUMENT:SElect.

Front Panel

Access: When in Spectrum measurement: **Amplitude Y Scale, Ref Level**

History: For PSA:  
Added revision A.02.00

For E4406A:  
Modified revision A.05.00

## Turn a Trace Display On/Off

**:DISPlay:TRACe[n] [:STATe] OFF|ON|0|1**

**:DISPlay:TRACe[n] [:STATe] ?**

Controls whether the specified trace is visible or not.

*n* is a sub-opcode that is valid for the current measurement. See the “[MEASure Group of Commands](#)” on page 519 for more information about sub-opcodes.

Factory Preset: On

Range: The valid traces and their sub-opcodes are dependent upon the selected measurement. See the following table.

The trace name assignment is independent of the window number.

Remarks: For E4406A to use this command, the appropriate mode should be selected with INSTRUMENT:SElect.

Remarks: For PSA you must be in the Basic, cdmaOne, cdma2000, 1xEV-DO, W-CDMA, GSM (w/EDGE), NADC, or PDC mode to use this command. Use INSTRUMENT:SElect to set the mode

Front Panel

Access: **Display, Display Traces**

Measurement	Available Traces	Markers Available?
ACP - adjacent channel power (Basic, cdmaOne, cdma2000, W-CDMA, iDEN (E4406A only), WiDEN (E4406A only), NADC, PDC modes)	no traces ( <i>n=0</i> ) <sup>a</sup> for I/Q points	no markers
BER - bit error rate (iDEN, WiDEN mode, E4406A only)	no traces ( <i>n=0</i> ) <sup>a</sup> for I/Q data	no markers

Measurement	Available Traces	Markers Available?
CDPower - code domain power (cdmaOne mode)	POWer ( $n=2$ ) <sup>a</sup> TIMing ( $n=3$ ) <sup>a</sup> PHASe ( $n=4$ ) <sup>a</sup> ( $n=0$ ) <sup>a</sup> for I/Q points	yes
CDPower - code domain power (cdma2000, 1xEV-DO, W-CDMA modes)	( $n=0$ ) <sup>a</sup> for I/Q raw data CDPower ( $n=2$ ) <sup>a</sup> EVM ( $n=5$ ) <sup>a</sup> MERRor ( $n=6$ ) <sup>a</sup> PERRor ( $n=7$ ) <sup>a</sup> SPOWer ( $n=9$ ) <sup>a</sup> CPOWer ( $n=10$ ) <sup>a</sup>	yes
CHPower - channel power (Basic, cdmaOne, cdma2000, 1xEV-DO, W-CDMA modes)	SPECtrum ( $n=2$ ) <sup>a</sup> ( $n=0$ ) <sup>a</sup> for I/Q raw data	no markers
CSPur - spurs close (cdmaOne mode)	SPECtrum ( $n=2$ ) <sup>a</sup> ULIMit ( $n=3$ ) <sup>a</sup> ( $n=0$ ) <sup>a</sup> for I/Q points	yes
EEVM - EDGE error vector magnitude (EDGE mode)	EVMerror ( $n=2$ ) <sup>a</sup> MERRor ( $n=3$ ) <sup>a</sup> PERRor ( $n=4$ ) <sup>a</sup> ( $n=0$ ) <sup>a</sup> for I/Q points	yes
EORFspectr - EDGE output RF spectrum (EDGE mode)	RFEMod ( $n=2$ ) <sup>a</sup> RFESwitching ( $n=3$ ) <sup>a</sup> SPEMod ( $n=4$ ) <sup>a</sup> LIMMod ( $n=5$ ) <sup>a</sup> ( $n=0$ ) <sup>a</sup> for I/Q points	yes, only for a single offset  yes, only for multiple offsets

Measurement	Available Traces	Markers Available?
EPVTime - EDGE power versus time (EDGE mode)	RFENvelope ( $n=2$ ) <sup>a</sup> UMASk ( $n=3$ ) <sup>a</sup> LMASk ( $n=4$ ) <sup>a</sup> ( $n=0$ ) <sup>a</sup> for I/Q points	yes
ETSPur - EDGE transmit band spurs (EDGE mode)	SPECtrum ( $n=2$ ) <sup>a</sup> ULIMit ( $n=3$ ) <sup>a</sup> ( $n=0$ ) <sup>a</sup> for I/Q points	yes
EVM - error vector magnitude (NADC, PDC modes)	EVM ( $n=2$ ) <sup>a</sup> MERRor ( $n=3$ ) <sup>a</sup> PERRor ( $n=4$ ) <sup>a</sup> ( $n=0$ ) <sup>a</sup> for I/Q points	yes
EVMQpsk - QPSK error vector magnitude (cdma2000, 1xEV-DO, W-CDMA modes)	EVM ( $n=2$ ) <sup>a</sup> MERRor ( $n=3$ ) <sup>a</sup> PERRor ( $n=4$ ) <sup>a</sup> ( $n=0$ ) <sup>a</sup> for I/Q raw data	yes
IM - intermodulation (cdma2000, 1xEV-DO, W-CDMA modes)	SPECtrum ( $n=2$ ) <sup>a</sup> ( $n=0$ ) <sup>a</sup> for I/Q raw data	yes
MCPower - multi-carrier power (W-CDMA mode)	no traces ( $n=0$ ) <sup>a</sup> for I/Q points	no markers
OBW - occupied bandwidth (cdmaOne, cdma2000, 1xEV-DO, iDEN (E4406A only), WiDEN (E4406A only), PDC, W-CDMA modes)	no traces ( $n=0$ ) <sup>a</sup> for I/Q raw data	no markers
ORFSpectrum - output RF spectrum (GSM, EDGE mode)	RFEMod ( $n=2$ ) <sup>a</sup> RFESwitching ( $n=3$ ) <sup>a</sup> SPEMod ( $n=4$ ) <sup>a</sup> LIMMod ( $n=5$ ) <sup>a</sup> ( $n=0$ ) <sup>a</sup> for I/Q points	yes, only for a single offset  yes, only for multiple offsets

Measurement	Available Traces	Markers Available?
PFErRor - phase and frequency error (GSM, EDGE mode)	PERRor ( $n=2$ ) <sup>a</sup> PFERror ( $n=3$ ) <sup>a</sup> RFENvelope ( $n=4$ ) <sup>a</sup> ( $n=0$ ) <sup>a</sup> for I/Q points	yes
PStAtistic - power statistics CCDF (Basic, cdma2000, 1xEV-DO, W-CDMA modes)	MEASured ( $n=2$ ) <sup>a</sup> GAUSian ( $n=3$ ) <sup>a</sup> REFerence ( $n=4$ ) <sup>a</sup> ( $n=0$ ) <sup>a</sup> for I/Q points	yes
PVTime - power versus time (GSM, EDGE, 1xEV-DO, Service (E4406A only) modes)	( $n=0$ ) <sup>a</sup> for I/Q raw data RFENvelope ( $n=2$ ) <sup>a</sup> UMASk ( $n=3$ ) <sup>a</sup> LMASk ( $n=4$ ) <sup>a</sup>	yes
RHO - modulation quality (cdmaOne, cdma2000, W-CDMA mode)	( $n=0$ ) <sup>a</sup> for I/Q raw data EVM ( $n=2$ ) <sup>a</sup> MERRor ( $n=3$ ) <sup>a</sup> PERRor ( $n=4$ ) <sup>a</sup> ( $n=5$ ) <sup>a</sup> for I/Q corrected trace data	yes
RHO - modulation quality (1xEV-DO mode)	( $n=0$ ) <sup>a</sup> for I/Q raw data ( $n=1$ ) <sup>a</sup> for various summary results EVM ( $n=2$ ) <sup>a</sup> MERRor ( $n=3$ ) <sup>a</sup> PERRor ( $n=4$ ) <sup>a</sup> ( $n=5$ ) <sup>a</sup> for I/Q corrected trace data	yes



Measurement	Available Traces	Markers Available?
SEMask - spectrum emissions mask (cdma2000, 1xEV-DO, W-CDMA mode)	SPECtrum ( $n=2$ ) <sup>a</sup>  ( $n=0$ ) <sup>a</sup> for I/Q raw data	yes
TSPur - transmit band spurs (GSM, EDGE mode)	SPECtrum ( $n=2$ ) <sup>a</sup>  ULIMit ( $n=3$ ) <sup>a</sup>  ( $n=0$ ) <sup>a</sup> for I/Q points	yes
TXPower - transmit power (GSM, EDGE mode)	RFENvelope ( $n=2$ ) <sup>a</sup>  IQ ( $n=8$ ) <sup>a</sup>  ( $n=0$ ) <sup>a</sup> for I/Q points	yes
SPECtrum - (frequency domain) (all modes)	RFENvelope ( $n=2$ ) <sup>a</sup> for Service mode (E4406A only)  IQ ( $n=3$ ) <sup>a</sup>  SPECtrum ( $n=4$ ) <sup>a</sup>  ASPectrum ( $n=7$ ) <sup>a</sup>  ( $n=0$ ) <sup>a</sup> for I/Q raw data	yes
WAVEform - (time domain) (all modes)	RFENvelope ( $n=2$ ) <sup>a</sup> (also for Signal Envelope trace)  IQ ( $n=5$ ) <sup>a</sup>  ( $n=0$ ) <sup>a</sup> for I/Q raw data	yes

a. The  $n$  number indicates the sub-opcode that corresponds to this trace. Detailed descriptions of the trace data can be found in the MEASure subsystem documentation by looking up the sub-opcode for the appropriate measurement.

### Waveform - Y-Axis Scale/Div

```
:DISPlay:WAVEform[n]:WINDow[m]:TRACe:Y[:SCALE]:PDIVision
<power>
```

```
:DISPlay:WAVEform[n]:WINDow[m]:TRACe:Y[:SCALE]:PDIVision?
```

Sets the scale per division for the y-axis.

n, selects the view, the default is RF envelope.

n=1, m=1 RF envelope

n=2, m=1 I/Q Waveform

n=2, m=1 I and Q Waveform (Option B7C, E4406A only)

n=4, m=1 I/Q Polar (Basic, W-CDMA, cdma2000)

n=5, m=1 Linear Envelope (Option B7C, E4406A only)

m, selects the window within the view. The default is 1.

Factory Preset: 10 dBm, for RF envelope

Range: .1 dB to 20 dB, for RF envelope

Default Unit: dBm, for RF envelope

Remarks: May affect input attenuator setting.

For E4406A to use this command, the appropriate mode should be selected with INSTRUMENT:SElect.

For PSA you must be in Basic, cdmaOne, cdma2000, 1xEV-DO, W-CDMA GSM w/EDGE, NADC, or PDC mode. Set the mode with INSTRUMENT:SElect.

Front Panel

Access: When in Waveform measurement: **Amplitude Y Scale, Scale/Div.**

History: For PSA:  
Added revision A.02.00  
For E4406A:  
Modified revision A.05.00

## Waveform - Y-Axis Reference Level

**:DISPlay:WAVeform[n] :WINDow[m] :TRACe:Y[:SCALE] :RLEVel  
<power>**

**:DISPlay:WAVeform[n] :WINDow[m] :TRACe:Y[:SCALE] :RLEVel?**

Sets the amplitude reference level for the y-axis.

n, selects the view, the default is RF envelope.

n=1, m=1 RF envelope

n=2, m=1 I/Q Waveform

n=2, m=1 I and Q Waveform (Option B7C, E4406A only)

n=4, m=1 I/Q Polar (Basic, W-CDMA, cdma2000)

n=5, m=1 Linear Envelope (Option B7C, E4406A only)

m, selects the window within the view. The default is 1.

Factory Preset: 0 dBm, for RF envelope

Range: -250 to 250 dBm, for RF envelope

Default Unit: dBm, for RF envelope

Remarks: May affect input attenuator setting.

For E4406A to use this command, the appropriate mode should be selected with INSTRUMENT:SElect.

For PSA you must be in Basic, cdmaOne, cdma2000, 1xEV-DO, W-CDMA GSM w/EDGE, NADC, or PDC mode. Set the mode with INSTRUMENT:SElect.

Front Panel

Access: When in Waveform measurement: **Amplitude Y Scale, Ref Level**

History: For PSA:  
Added revision A.02.00

For E4406A:  
Modified revision A.05.00

---

## FETCh Subsystem

The FETCh? queries are used with several other commands to control the measurement process. These commands are described in the section on the “[MEASure Group of Commands](#)” on page 332. These commands apply only to measurements found in the MEASURE menu.

This command puts selected data from the most recent measurement into the output buffer (new data is initiated/measured). Use FETCh if you have already made a good measurement and you want to look at several types of data (different [n] values) from the single measurement. FETCh saves you the time of re-making the measurement. You can only fetch results from the measurement that is currently active.

If you need to make a new measurement, use the READ command, which is equivalent to an INITiate[:IMMEDIATE] followed by a FETCh.

:FETCh <meas>? will return valid data only when the measurement is in one of the following states:

- idle
- initiated
- paused

### Fetch the Current Measurement Results

**:FETCh: <measurement> [n] ?**

A FETCh? command must specify the desired measurement. It will return the valid results that are currently available, but will not initiate the taking of any new data. You can only fetch results from the measurement that is currently selected. The code number n selects the kind of results that will be returned. The available measurements and data results are described in the “[MEASure Group of Commands](#)” on page 332.

## FORMat Subsystem

The FORMat subsystem sets a data format for transferring numeric and array information. For PSA the TRACe[:DATA] command is affected by FORMat subsystem commands.

### Byte Order

**:FORMat:BORDER NORMAl | SWAPped**

**:FORMat:BORDER?**

Selects the binary data byte order for numeric data transfer. In normal mode the most significant byte is sent first. In swapped mode the least significant byte is first. (PCs use the swapped order.) Binary data byte order functionality does not apply to ASCII.

Factory Preset: Normal

Remarks: You must be in the Basic, cdma2000, 1xEV-DO, W-CDMA, GSM (w/EDGE), NADC, or PDC mode to use this command. Use INSTRument:SElect to set the mode.

### Numeric Data Format

PSA/VSA Basic, cdmaOne, cdma2000, 1xEV-DO, W-CDMA, GSM, EDGE, NADC, PDC modes:

**:FORMat[:DATA] ASCii | REAL,32 | REAL,64**

**:FORMat[:DATA]?**

PSA Spectrum Analysis mode only:

**:FORMat[:TRACe][:DATA]**

**ASCii | INTeger,16 | INTeger,32 | REAL,32 | REAL,64 | UINTegeR,16**

**:FORMat[:TRACe][:DATA]?**

PSA Noise Figure mode only:

**:FORMat[:TRACe][:DATA] ASCii | REAL[,32]**

**:FORMat[:TRACe][:DATA]?**

VSA/PSA application modes: This command controls the format of data input/output, that is any data transfer across any remote port. The REAL and ASCII formats will format data in the current display units. The format of state data cannot be changed. It is always in a machine

readable format only.

ASCII - Amplitude values are in ASCII, in amplitude units, separated by commas. ASCII format requires more memory than the binary formats. Therefore, handling large amounts of this type of data, will take more time and storage space.

Integer,16 - Binary 16-bit integer values in internal units (dBm), in a definite length block. \*\*PSA, SA mode only.

Integer,32 - Binary 32-bit integer values in internal units (dBm), in a definite length block.

Real,32 or Real,64 - Binary 32-bit (or 64-bit) real values in amplitude unit, in a definite length block. Transfers of real data are done in a binary block format.

UINteger,16 - Binary 16-bit unsigned integer that is uncorrected ADC values, in a definite length block. This format is almost never applicable with current measurement data.

A definite length block of data starts with an ASCII header that begins with # and indicates how many additional data points are following in the block. Suppose the header is #512320.

- The first digit in the header (5) tells you how many additional digits/bytes there are in the header.
- The 12320 means 12 thousand, 3 hundred, 20 data bytes follow the header.
- Divide this number of bytes by your selected data format bytes/point, either 8 (for real 64), or 4 (for real 32). In this example, if you are using real 64 then there are 1540 points in the block.

Example:        FORM REAL,64

Factory Preset: ASCII

Real,32 for Spectrum Analysis mode

ASCII for Basic, cdmaOne, cdma2000, 1xEV-DO,  
W-CDMA, GSM with EDGE, NADC, PDC modes

Remarks:        The acceptable settings for this command change for the different modes as described above.

## INITiate Subsystem

The INITiate subsystem is used to initiate a trigger for a measurement. These commands only initiate measurements from the MEASURE front panel key or the “MEASure Group of Commands” on page 332. Refer also to the TRIGger and ABORt subsystems for related commands.

### Take New Data Acquisition for Selected Measurement

**:INITiate:<measurement>**

This command initiates a trigger cycle for the measurement specified, but does not return data. The available measurement names are described in the MEASure subsystem.

If your selected measurement is not currently active it will change to the measurement in your INIT:<meas> command and initiate a trigger cycle.

For PSA this command is not available for one-button measurements in the Spectrum Analysis mode.

Example:       INIT:ACP

### Continuous or Single Measurements

**:INITiate:CONTinuous OFF|ON|0|1**

**:INITiate:CONTinuous?**

Selects whether a trigger is continuously initiated or not. Each trigger initiates a single, complete, measurement operation.

When set to ON another trigger cycle is initiated at the completion of each measurement.

When set to OFF, the trigger system remains in the “idle” state until an INITiate[:IMMediate] command is received. On receiving the INITiate[:IMMediate] command, it will go through a single trigger/measurement cycle, and then return to the “idle” state.

Example:       INIT:CONT ON

Factory Preset: On

\*RST:           Off (recommended for remote operation)

Front Panel

Access:         **Meas Control, Measure Cont Single**

## Take New Data Acquisitions

**:INITiate[:IMMediate]**

The instrument must be in the single measurement mode. If INIT:CONT is ON, then the command is ignored. The desired measurement must be selected and waiting. The command causes the system to exit the “waiting” state and go to the “initiated” state.

The trigger system is initiated and completes one full trigger cycle. It returns to the “waiting” state on completion of the trigger cycle. Depending upon the measurement and the number of averages, there may be multiple data acquisitions, with multiple trigger events, for one full trigger cycle.

This command triggers the instrument, if external triggering is the type of trigger event selected. Otherwise, the command is ignored. Use the TRIGger[:SEQuence]:SOURce EXT command to select the external trigger.

Example:       INIT:IMM

Remarks:       See also the \*TRG command and the TRIGger subsystem.

Front Panel

Access:        **Meas Control, Measure Cont Single**

## Restart the Measurement

**:INITiate:REStart**

This command applies to measurements found in the MEASURE menu. It restarts the current measurement from the “idle” state regardless of its current operating state. It is equivalent to:

INITiate[:IMMediate]

ABORt (for continuous measurement mode)

Example:       INIT:REST

Front Panel

Access:        **Restart**

or

**Meas Control, Restart**



## INSTrument Subsystem

This subsystem includes commands for querying and selecting instrument measurement (personality option) modes.

### Catalog Query

For E4406A, **:INSTrument:CATalog[:FULL]?**

For PSA, **:INSTrument:CATalog?**

Returns a comma separated list of strings which contains the names of all the installed applications. These names can only be used with the **INST:SELEct** command.

For E4406A if the optional keyword **FULL** is specified, each name is immediately followed by its associated instrument number. These instrument numbers can only be used with the **INST:NSELEct** command.

Example:

(PSA) **INST:CAT?**

Query response: "CDMA"4,"PNOISE"14

Example:

(E4406A) **INST:CAT:FULL?**

Query response:  
 "BASIC"8,"GSM"3,"CDMA"4,"SERVICE"1

### Select Application by Number

**:INSTrument:NSELEct <integer>**

**:INSTrument:NSELEct?**

Select the measurement mode by its instrument number. The actual available choices depends upon which applications are installed in the instrument. For E4406A these instrument numbers can be obtained with **INST:CATalog:FULL?**

- 1 = SA (PSA)
- 1 = SERVICE (E4406A)
- 3 = GSM (E4406A)
- 4 = CDMA (cdmaOne)
- 5 = NADC
- 6 = PDC
- 8 = BASIC
- 9 = WCDMA (3GPP W-CDMA with HSDPA)

10 = CDMA2K (cdma2000 with 1xEV-DV)  
11 = IDEN (E4406A)  
13 = EDGE GSM  
14 = PNOISE (phase noise) (PSA)  
15 = CDMA1XEV (1xEV-D0)  
? = TDSCDMA (PSA)  
219 = NOISE FIGURE (PSA)  
266 = ??? (8566/68 Programming Compatibility) (PSA)

---

**NOTE**

If you are using the SCPI status registers and the analyzer mode is changed, the status bits should be read, and any errors resolved, prior to switching modes. Error conditions that exist prior to switching modes cannot be detected using the condition registers after the mode change. This is true unless they recur after the mode change, although transitions of these conditions can be detected using the event registers.

Changing modes resets all SCPI status registers and mask registers to their power-on defaults. Hence, any event or condition register masks must be re-established after a mode change. Also note that the power up status bit is set by any mode change, since that is the default state after power up.

---

Example:       INST:NSEL 4

Factory Preset: Persistent state with factory default of 1 (PSA)

Persistent state with factory default of 8  
(E4406A, BASIC)

Range:         1 to x, where x depends upon which applications are installed.

Front Panel

Access:        **MODE**

## Select Application

VSA E4406A:

```
:INSTrument [ :SElect ]  
BASIC | SERVICE | CDMA | CDMA2K | GSM | EDGE GSM | IDEN | NADC  
| PDC | WCDMA | CDMA1XEV
```

PSA Series:

```
:INSTrument [ :SElect ]  
SA | PNOISE | BASIC | CDMA | CDMA2K | EDGE GSM | NADC | PDC  
| WCDMA | CDMA1XEV | NFIGURE
```

```
:INSTrument [ :SElect ] ?
```

Select the measurement mode. The actual available choices depend

upon which modes (measurement applications) are installed in the instrument. A list of the valid choices is returned with the `INST:CAT?` query.

Once an instrument mode is selected, only the commands that are valid for that mode can be executed.

- 1 = SA (PSA)
- 1 = SERVICE (E4406A)
- 3 = GSM (E4406A)
- 4 = CDMA (cdmaOne)
- 5 = NADC
- 6 = PDC
- 8 = BASIC
- 9 = WCDMA (3GPP W-CDMA with HSDPA)
- 10 = CDMA2K (cdma2000 with 1xEV-DV)
- 11 = IDEN (E4406A)
- 13 = EDGE GSM
- 14 = PNOISE (phase noise) (PSA)
- 15 = CMDA1XEV (1xEV-D0)
- ? = TDSCDMA (PSA)
- 219 = NOISE FIGURE (PSA)
- 266 = ??? (8566/68 Programming Compatibility) (PSA)

---

**NOTE**

If you are using the status bits and the analyzer mode is changed, the status bits should be read, and any errors resolved, prior to switching modes. Error conditions that exist prior to switching modes cannot be detected using the condition registers after the mode change. This is true unless they recur after the mode change, although transitions of these conditions can be detected using the event registers.

Changing modes resets all SCPI status registers and mask registers to their power-on defaults. Hence, any event or condition register masks must be re-established after a mode change. Also note that the power up status bit is set by any mode change, since that is the default state after power up.

---

Example:       ESA Series instruments: `INST:SEL 'CDMA'`

Example:       PSA Series instruments: `INST:SEL CDMA`

Factory Preset:  
 (PSA)           Persistent state with factory default of Spectrum Analyzer mode

Factory Preset:  
 (E4406A)       Persistent state with factory default of Basic mode.

Front Panel  
 Access:        **MODE**

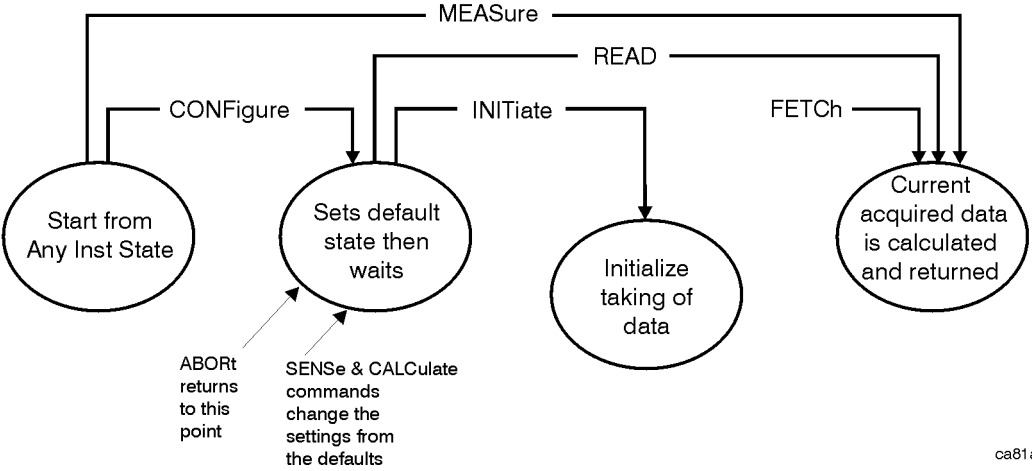
## MEASure Group of Commands

This group includes the CONFigure, FETCh, MEASure, and READ commands that are used to make measurements and return results. The different commands can be used to provide fine control of the overall measurement process, like changing measurement parameters from their default settings. Most measurements should be done in single measurement mode, rather than measuring continuously.

The SCPI default for the format of any data output is ASCII. The format can be changed to binary with FORMat:DATA which transports faster over the bus.

# Command Interactions: MEASure, CONFigure, FETCh, INITiate and READ

Figure 4-3 Measurement Group of Commands



Programming Commands

### Measure Commands:

:MEASure:<measurement>[n]?

This is a fast single-command way to make a measurement using the factory default instrument settings. These are the settings and units that conform to the Mode Setup settings (e.g. radio standard) that you have currently selected.

- Stops the current measurement (if any) and sets up the instrument for the specified measurement using the factory defaults
- Initiates the data acquisition for the measurement
- Blocks other SCPI communication, waiting until the measurement is complete before returning results.
- After the data is valid it returns the scalar results, or the trace data, for the specified measurement. The type of data returned may be defined by an [n] value that is sent with the command.

The scalar measurement results will be returned if the optional [n] value is not included, or is set to 1. If the [n] value is set to a value other than 1, the selected trace data results will be returned. See each command for details of what types of scalar results or trace data results are available.

ASCII is the default format for the data output. (Older versions of Spectrum Analysis and Phase Noise mode measurements only use ASCII.) The binary data formats should be used for handling large blocks of data since they are smaller and faster than the ASCII format. Refer to the FORMat:DATA command for more information.

If you need to change some of the measurement parameters from the factory default settings you can set up the measurement with the CONFigure command. Use the commands in the SENSE:<measurement> and CALCulate:<measurement> subsystems to change the settings. Then you can use the READ? command to initiate the measurement and query the results. See [Figure 4-3](#).

If you need to repeatedly make a given measurement with settings other than the factory defaults, you can use the commands in the SENSE:<measurement> and CALCulate:<measurement> subsystems to set up the measurement. Then use the READ? command to initiate the measurement and query results.

Measurement settings persist if you initiate a different measurement and then return to a previous one. Use READ:<measurement>? if you want to use those persistent settings. If you want to go back to the default settings, use MEASure:<measurement>?.

### Configure Commands:

**:CONFigure: <measurement>**

This command stops the current measurement (if any) and sets up the instrument for the specified measurement using the factory default instrument settings. It sets the instrument to single measurement mode but should not initiate the taking of measurement data unless INIT:CONTinuous is ON. After you change any measurement settings, the READ command can be used to initiate a measurement without changing the settings back to their defaults.

**NOTE** In instruments with firmware older than A.05.00 CONFigure initiates the taking of data. The data should be ignored. Other SCPI commands can be processed immediately after sending CONFigure. You do not need to wait for the CONF command to complete this 'false' data acquisition.

The CONFigure? query returns the current measurement name.

### Fetch Commands:

**:FETCh: <measurement> [n] ?**

This command puts selected data from the most recent measurement into the output buffer. Use FETCh if you have already made a good measurement and you want to return several types of data (different [n] values, e.g. both scalars and trace data) from a single measurement. FETCh saves you the time of re-making the measurement. You can only FETCh results from the measurement that is currently active, it will not change to a different measurement.

If you need to get new measurement data, use the READ command, which is equivalent to an INITiate followed by a FETCh.

The scalar measurement results will be returned if the optional [n] value is not included, or is set to 1. If the [n] value is set to a value other than 1, the selected trace data results will be returned. See each command for details of what types of scalar results or trace data results are available. The binary data formats should be used for handling large blocks of data since they are smaller and transfer faster than the ASCII format. (FORMat:DATA)

FETCh may be used to return results other than those specified with the original READ or MEASure command that you sent.

### INITiate Commands:

**:INITiate: <measurement>**

This command is not available for measurements in all the instrument modes:

- Initiates a trigger cycle for the specified measurement, but does not output any data. You must then use the `FETCh<meas>` command to return data. If a measurement other than the current one is specified, the instrument will switch to that measurement and then initiate it.  
For example, suppose you have previously initiated the ACP measurement, but now you are running the channel power measurement. If you send `INIT:ACP?` it will change from channel power to ACP and will initiate an ACP measurement.
- Does not change any of the measurement settings. For example, if you have previously started the ACP measurement and you send `INIT:ACP?` it will initiate a new ACP measurement using the same instrument settings as the last time ACP was run.
- If your selected measurement is currently active (in the idle state) it triggers the measurement, assuming the trigger conditions are met. Then it completes one trigger cycle. Depending upon the measurement and the number of averages, there may be multiple data acquisitions, with multiple trigger events, for one full trigger cycle. It also holds off additional commands on GPIB until the acquisition is complete.

### READ Commands:

**:READ: <measurement> [n] ?**

- Does not preset the measurement to the factory default settings. For example, if you have previously initiated the ACP measurement and you send `READ:ACP?` it will initiate a new measurement using the same instrument settings.
- Initiates the measurement and puts valid data into the output buffer. If a measurement other than the current one is specified, the instrument will switch to that measurement before it initiates the measurement and returns results.  
For example, suppose you have previously initiated the ACP measurement, but now you are running the channel power measurement. Then you send `READ:ACP?` It will change from channel power back to ACP and, using the previous ACP settings, will initiate the measurement and return results.
- Blocks other SCPI communication, waiting until the measurement is complete before returning the results

If the optional [n] value is not included, or is set to 1, the scalar measurement results will be returned. If the [n] value is set to a value other than 1, the selected trace data results will be returned. See each command for details of what types of scalar results or trace data results are available. The binary data formats should be used when handling large blocks of data since they are smaller and faster than the ASCII format. (`FORMat:DATA`)



## 50 MHz Amplitude Reference Measurement

This aligns the internal 50 MHz reference signal to an external reference signal that you supply. You must be in the Service mode to use these commands. Use INSTRument:SElect to set the mode.

The general functionality of CONFigure, FETCh, MEASure, and READ are described at the beginning of this section. See the SENSE:AREference commands for more measurement related commands.

**:CONFigure:AREference**

**:INITiate:AREference**

**:FETCh:AREference [n] ?**

**:READ:AREference [n] ?**

**:MEASure:AREference [n] ?**

Remarks: For auto adjustment of the internal 50 MHz amplitude reference, use CALibration:AMPLitude:REference:AADJust command after this measurement has been selected.

Front Panel

Access: **Measure, 50 MHz Amptd**

After the measurement is selected, press **Restore Meas Defaults** to restore factory defaults.

### Measurement Results Available

<b>n</b>	<b>Results Returned</b>
n=1 (or not specified)	Returns scalar results: <ol style="list-style-type: none"> <li>1. RF input average amplitude</li> <li>2. 50 MHz reference oscillator average amplitude</li> <li>3. Average amplitude error</li> <li>4. State (for factory use only)</li> <li>5. Level (for factory use only)</li> <li>6. Monitored level (for factory use only)</li> <li>7. Connector status (for factory use only)</li> </ol>
2	RF input amplitude trace data.
3	50 MHz oscillator amplitude trace data
4	Amplitude error strip chart trace data

## EDGE Error Vector Magnitude Measurement

This measures the vector error of the magnitude of each symbol. You must be in the EDGE(w/GSM) mode to use these commands. Use INSTRument:SElect to set the mode.

The general functionality of CONFigure, FETCh, MEASure, and READ are described at the beginning of this section. See the SENSE:EEVM commands for more measurement related commands.

**:CONFigure:EEVM**

**:INITiate:EEVM**

**:FETCh:EEVM[n]?**

**:READ:EEVM[n]?**

**:MEASure:EEVM[n]?**

History:           Version A.04.00 or later

Front Panel

Access:           **Measure, EDGE EVM**

After the measurement is selected, press **Restore Meas Defaults** to restore factory defaults.

### Measurement Results Available

<b>n</b>	<b>Results Returned</b>
0	Returns unprocessed I/Q trace data, as a data array of trace point values, in volts.

n	Results Returned
1 (default)	<p>Returns the following 15 scalar results, in order.</p> <ol style="list-style-type: none"> <li>1. RMS 95th %tile EVM – a floating point number (in percent) of EVM over 95% of the entire measurement area.</li> <li>2. RMS EVM – a floating point number (in percent) of EVM over the entire measurement area.</li> <li>3. Maximum RMS EVM – a floating point number (in percent) of highest EVM over the entire measurement area.</li> <li>4. Peak EVM – a floating point number (in percent) of the average of the peak EVMs. Take the peak EVMs from each burst and average them together.</li> <li>5. Maximum peak EVM – a floating point number (in percent) of the maximum peak EVM. Take the peak EVMs from each burst and identify the highest peak.</li> <li>6. Symbol position of the peak EVM error – an integer number of the symbol position where the peak EVM error is detected.</li> <li>7. Magnitude error – a floating point number (in percent) of average magnitude error over the entire measurement area.</li> <li>8. Maximum magnitude error – a floating point number (in percent) of maximum magnitude error over the entire measurement area.</li> <li>9. Phase error – a floating point number (in degree) of average phase error over the entire measurement area.</li> <li>10. Maximum Phase error – a floating point number (in degree) of maximum phase error over the entire measurement area.</li> <li>11. Frequency error – a floating point number (in Hz) of the frequency error in the measured signal.</li> <li>12. Maximum frequency error – a floating point number (in Hz) of the highest frequency error in the measured signal.</li> <li>13. I/Q origin offset – a floating point number (in dB) of the I and Q error (magnitude squared) offset from the origin.</li> <li>14. Droop Error – a floating point number (in dB) of the amplitude droop measured across the 142 symbol burst.</li> <li>15. Trigger to T0 - a floating-point number of the time interval between the trigger point to T0. T0 means the transition time from symbol 13 to symbol 14 of the midamble training sequence for each time slot. Unit is sec</li> </ol>
2	<p>Returns series of floating point numbers (in percent) that represent each sample in the EVM vector trace for the last slot. The first number is the symbol 0 decision point and there is 1 point per symbol.</p>
3	<p>Returns series of floating point numbers (in percent) that represent each sample in the magnitude error vector trace for the last slot. The first number is the symbol 0 decision point and there is 1 point per symbol.</p>

n	Results Returned
4	Returns series of floating point numbers (in degree) that represent each sample in the phase error vector trace for the last slot. The first number is the symbol 0 decision point and there is 1 point per symbol.
5	<p>Returns series of floating point numbers that alternately represent I and Q pairs of the final corrected measured data for the last slot. The magnitude of each I and Q pair are normalized to 1.0. The first number is the in-phase (I) sample of symbol 0 decision point and the second is the quadrature-phase (Q) sample of symbol 0 decision point. As in the EVM, there is 1 point per symbol, so the series of numbers is:</p> <p>1st number = I of the symbol 0 decision point            2nd number = Q of the symbol 0 decision point            . . .            (2) + 1 (or 3rd) number = I of the symbol 1 decision point            (2) + 2 (or 4th) number = Q of the symbol 1 decision point            . . .            (2) × N + 1 number = I of the symbol N decision point            (2) × N + 2 number = Q of the symbol N decision point</p>
6	<p>Returns comma-separated scalar values of pass/fail (0.0= passed, 1.0= failed) results determined by testing EVM:</p> <ol style="list-style-type: none"> <li>1. Test results of RMS EVM</li> <li>2. Test results of Peak EVM</li> <li>3. Test results of 95% tile EVM</li> <li>4. Test results of I/Q Origin Offset</li> <li>5. Test results of Frequency Error</li> </ol>
7	Returns series of integer values that represent the demoded symbols (octal bits) of the final corrected measured data for the last slot. Each bit/symbol is represented as a value between 0 - 7. All 142 symbols in slot are returned.

## EDGE Output RF Spectrum Measurement

This measures adjacent channel power. From 1 to 15 offsets can be measured at one time. You must be in the EDGE(w/GSM) mode to use these commands. Use INSTRument:SElect to set the mode.

The general functionality of CONFigure, FETCh, MEASure, and READ are described at the beginning of this section. See the SENSE:EORFspectr commands for more measurement related commands.

**:CONFigure:EORFspectr**

**:INITiate:EORFspectr**

**:FETCh:EORFspectr [n] ?**

**:READ:EORFspectr [n] ?**

**:MEASure:EORFspectr [n] ?**

History: Version A.04.00 or later. Modified in version A.05.00.

Front Panel

Access: **Measure, EDGE Output RF Spectrum**

After the measurement is selected, press **Restore Meas Defaults** to restore factory defaults.

### Measurement Results Available

The default settings for the MEASure command only measure the carrier and 5 standard offsets. The default does not measure the switching transients. If you use the CONFigure, INITiate, and FETCh commands in place of the MEASure command, you can then use the SENSE commands to change the settings from these defaults. Use **[ :SENSe ] :EORFspectr :LIST :SWITCh CUSTom** to select a customized set of offsets. Use **[ :SENSe ] :EORFspectr :TYPE MSWitching** to measure switching in addition to measuring modulation. (The measurement will take longer when measuring switching transients.)

Measurement Method	n	Results Returned
	0	Returns unprocessed I/Q trace data, as a series of trace point values, in volts. The I values are listed first in each pair, using the 0 through even-indexed values. The Q values are the odd-indexed values.

Measurement Method	n	Results Returned
Single Offset	n=1 (or not specified)	Returns measurement results for the specified offset: <ol style="list-style-type: none"> <li>1. Modulation spectrum power, dB</li> <li>2. Modulation spectrum power, dBm</li> <li>3. Switching transient power, dB</li> <li>4. Switching transient power, dBm</li> </ol>
Multiple Offsets Switching -or- Multiple Offsets Modulation Discrete Mode	n=1 (or not specified)	<p>Returns a list of values for the modulation spectrum at all the offsets (lower and upper.) This is followed by the switching transients results at all the offsets (lower and upper). Note that the carrier is considered offset zero (0) and is the first set of results sent. Four values are provided for each of the offsets (including the carrier), in this order:</p> <ol style="list-style-type: none"> <li>1. Negative offset(a) - power relative to carrier (dB)</li> <li>2. Negative offset(a) - absolute average power (dBm)</li> <li>3. Positive offset(a) - power relative to carrier (dB)</li> <li>4. Positive offset(a) - absolute average power (dBm)</li> </ol> <p>Values for all possible offsets are sent. Zeros are sent for offsets that have not been defined. The total number of values sent (120) = (4 results/offset) × (15 offsets) × (2 measurement types - modulation &amp; switching)</p> <p>Carrier - modulation measurement values            Offset 1 - modulation measurement values            ...            Offset 14 - modulation measurement values            Carrier - switching transients measurement values            Offset 1 - switching transients measurement values            ...            Offset 14- switching transients measurement values</p> <p>This measurement defaults to modulation measurements and not switching measurements. If you want to return the switching measurement values, you must change that default condition and use FETCh or READ to return values, rather than MEASure.</p> <p>NOTE: When using custom modulation and switching offsets the maximum number of measured values returned is:</p> <p>13 modulation offsets + 0 Hz carrier            4 switching offsets + 0 Hz carrier</p>
Multiple Offsets Modulation Sweep Mode	n=1 (or not specified)	Returns measurement results of the closest point to the limit line: <ol style="list-style-type: none"> <li>1. Frequency</li> <li>2. Offset frequency from carrier frequency</li> <li>3. Power in dBm</li> <li>4. Delta from limit (dB)</li> <li>5. Delta from reference (dB)</li> </ol>

<b>Measurement Method</b>	<b>n</b>	<b>Results Returned</b>
Single Offset	2	Returns floating point numbers (in dBm) of the captured trace data. It contains N data points of the “spectrum due to modulation” signal, where N is the specified number of samples.
Single Offset	3	Returns floating point numbers (in dBm) of the captured trace data. It contains N data points of the “spectrum due to switching transients” signal, where N is the specified number of samples.
Multiple Offsets Modulation	4	Returns floating point numbers (in dBm) of the sweep spectrum of modulation.
Sweep Mode	5	Returns floating point numbers (in dBm) of the limit trace.

Measurement Method	n	Results Returned
<p>Meas Type = Mod &amp; Switch  AND  Meas Method = Multi-Offset  - or -  Meas Type = Modulation  AND  Meas Method = Multi-Offset  - or -  Meas Type = Switching  AND  Meas Method = Multi-Offset  - or -  Meas Type = Full Frame Mod (FAST)</p>	<p>6</p>	<p>Relative level to the test limit, and test limit itself for both modulation and switching transient measurements.</p> <p>Returns a list of relative level to the test limit, the relative test limit and the absolute test limit for all the offset frequencies. The relative level to the test limit is returned for both lower and upper offsets. Four values are returned for each offset in the following order:</p> <ol style="list-style-type: none"> <li>1. Relative level to the test limit (dB) at the negative offset frequency</li> <li>2. Relative level to the test limit (dB) at the positive offset frequency</li> <li>3. Relative test limit used (dB)</li> <li>4. Absolute test limit used (dBm)</li> </ol> <p>Values for all possible offsets are returned.</p> <p>The carrier frequency is considered offset zero (0.0 Hz) and is the first set of values returned.  Zeros are returned for offsets that have not been defined.</p> <p>Zeros are returned for the measurement that was not performed. For example, if Meas Type is Modulation, all switching transients measurement results will be 0.0.</p> <p>The total number of values returned is:  <math>120 = (4 \text{ results / offset}) * (15 \text{ offset frequencies}) * (2 \text{ measurement types})</math></p> <p>Carrier (Offset A) – modulation measurement results  Offset 1 (Offset B) - modulation measurement results  .....  Offset 14 (Offset O) - modulation measurement results  Carrier (Offset A)– switching transients measurement results  Offset 1 (Offset B) – switching transients measurement results  .....  Offset 14 (Offset O) – switching transients measurement results</p>



## EDGE Power vs. Time Measurement

This measures the average power during the “useful part” of the burst comparing the power ramp to required timing mask. You must be in EDGE(w/GSM) mode to use these commands. Use INSTRument:SElect to set the mode.

The general functionality of CONFigure, FETCh, MEASure, and READ are described at the beginning of this section. See the SENSE:EPVTime commands for more measurement related commands.

```
:CONFigure:EPVTime
:INITiate:EPVTime
:FETCh:EPVTime [n] ?
:READ:EPVTime [n] ?
:MEASure:EPVTime [n] ?
```

Front Panel

Access: **Measure, EDGE Pwr vsTime**

After the measurement is selected, press **Restore Meas Defaults** to restore factory defaults.

History: Modified in version A.05.00.

### Measurement Results Available

<b>n</b>	<b>Results Returned</b>
0	Returns unprocessed I/Q trace data, as a series of trace point values, in volts. The I values are listed first in each pair, using the 0 through even-indexed values. The Q values are the odd-indexed values.

n	Results Returned
n=1 (or not specified)	<p>Returns the following scalar results:</p> <ol style="list-style-type: none"> <li>1. <b>Sample time</b> is a floating point number that represents the time between samples when using the trace queries (n=0,2,etc.).</li> <li>2. <b>Power single burst</b> is the mean power (in dBm) across the useful part of the selected burst in the most recently acquired data, or in the last data acquired at the end of a set of averages. If averaging is on, the power is for the last burst.</li> <li>3. <b>Power averaged</b> is the power (in dBm) of N averaged bursts, if averaging is on. The power is averaged across the useful part of the burst. Average <i>m</i> is a single burst from the acquired trace. If there are multiple bursts in the acquired trace, only one burst is used for average <i>m</i>. This means that N traces are acquired to make the complete average. If averaging is off, the value of <b>power averaged</b> is the same as the <b>power single burst</b> value.</li> <li>4. <b>Number of samples</b> is the number of data points in the captured signal. This number is useful when performing a query on the signal (i.e. when n=0,2,etc.).</li> <li>5. <b>Start</b> is the index of the data point at the start of the useful part of the burst</li> <li>6. <b>Stop</b> is the index of the data point at the end of the useful part of the burst</li> <li>7. <math>T_0</math> is the index of the data point where <math>t_0</math> occurred</li> <li>8. <b>Burst width</b> is the width of the burst measured at -3dB below the mean power in the useful part of the burst.</li> <li>9. <b>Maximum value</b> is the maximum value of the most recently acquired data (in dBm).</li> <li>10. <b>Minimum value</b> is the minimum value of the most recently acquired data (in dBm).</li> <li>11. <b>Burst search threshold</b> is the value (in dBm) of the threshold where a valid burst is identified, after the data has been acquired.</li> <li>12. <b>IQ point delta</b> is the number of data points offset that are internally applied to the useful data in traces n=2,3,4. You must apply this correction value to find the actual location of the <b>Start</b>, <b>Stop</b>, or <math>T_0</math> values.  (e.g. for n=2, Start (for the IQ trace data) = Start + IQ_point_delta)</li> </ol>
2	Returns trace point values of the entire waveform data. These data points are floating point numbers representing the power of the signal (in dBm). There are N data points, where N is the <b>number of samples</b> . The period between the samples is defined by the <b>sample time</b> .
3	Returns data points representing the upper mask (in dBm).
4	Returns data points representing the lower mask (in dBm).

<b>n</b>	<b>Results Returned</b>
7	Returns power level values for the 8 slots in the current frame (in dBm).
8, only available when averaging is set to both maximum and minimum	<p>Returns trace point values of the minimum waveform data. These data points are floating point numbers representing the power of the signal (in dBm). There are N data points, where N is the <b>number of samples</b>. The period between the samples is defined by the <b>sample time</b>.</p> <p>Use SENSE:PVT:AVERAge:TYPE MXMinimum to set averaging to max and min. Use n=2 to return the corresponding maximum trace.</p>

## EDGE Transmit Band Spurs Measure Commands

This measures the spurious emissions in the transmit band relative to the channel power in the selected channel. You must be in the EDGE mode to use these commands. Use INSTRUMENT:SELEct to set the mode.

The general functionality of CONFigure, FETCh, MEASure, and READ are described at the beginning of this section. See the SENSE:TSPur commands for more measurement related commands.

**:CONFigure:ETSPur**

**:INITiate:ETSPur**

**:FETCh:ETSPur [n] ?**

**:READ:ETSPur [n] ?**

**:MEASure:ETSPur [n] ?**

History:           Version A.05.00 or later

Front Panel

Access:           **Measure, EDGE Tx Band Spurs**

After the measurement is selected, press **Restore Meas Defaults** to restore factory defaults.

### Measurement Results Available

n	Results Returned
0	Returns unprocessed I/Q trace data, as a series of trace points, in volts. The I values are listed first in each pair, using the 0 through even-indexed values. The Q values are the odd-indexed values.
n=1 (or not specified)	Returns scalar results: <ol style="list-style-type: none"> <li>1. The worst spur's frequency difference from channel center frequency (in MHz)</li> <li>2. The worst spur's amplitude difference from the limit (in dB)</li> <li>3. The worst spur's amplitude difference from the mean transmit power (in dB)</li> </ol>
2	Returns trace of the current segment spectrum.
3	[Returns trace of the current segment Upper Limit.]
4	Returns trace of Lower segment Spectrum.
5	Returns trace of Lower segment Upper Limit.
6	Returns trace of Lower Adj segment Spectrum.
7	Returns trace of Lower Adj segment Upper Limit.

<b>n</b>	<b>Results Returned</b>
8	Returns trace of Upper Adj segment Spectrum.
9	Returns trace of Upper Adj segment Upper Limit.
10	Returns trace of Upper segment Spectrum.
11	Returns trace of Upper segment Upper Limit.

## GMSK Output RF Spectrum Measurement

This measures adjacent channel power. From 1 to 15 offsets can be measured at one time. You must be in the EDGE, GSM mode to use these commands. Use INSTRUMENT:SELEct to set the mode.

The general functionality of CONFigure, FETCh, MEASure, and READ are described at the beginning of this section. See the SENSE:ORFSpectrum commands for more measurement related commands.

```
:CONFigure:ORFSpectrum
:INITiate:ORFSpectrum
:FETCh:ORFSpectrum[n]?
:READ:ORFSpectrum[n]?
:MEASure:ORFSpectrum[n]?
```

Front Panel

Access: **Measure, Output RF Spectrum**

After the measurement is selected, press **Restore Meas Defaults** to restore factory defaults.

### Measurement Results Available

The default settings for the MEASure command only measure the carrier and 5 standard offsets. The default does not measure the switching transients. If you use the CONFigure, INITiate, and FETCh commands in place of the MEASure command, you can then use the SENSE commands to change the settings from these defaults. Use **[ :SENSE ] :ORFSpectrum:LIST:SWITCh CUSTOM** to select a customized set of offsets. Use **[ :SENSE ] :ORFSpectrum:TYPE MSwitching** to measure switching in addition to measuring modulation. (The measurement will take longer when measuring switching transients.)

Measurement Method	n	Results Returned
	0	Returns unprocessed I/Q trace data, as a series of trace point values, in volts. The I values are listed first in each pair, using the 0 through even-indexed values. The Q values are the odd-indexed values.
Single Offset	n=1 (or not specified)	Returns measurement results for the specified offset: <ol style="list-style-type: none"> <li>1. Modulation spectrum power, dB</li> <li>2. Modulation spectrum power, dBm</li> <li>3. Switching transient power, dB</li> <li>4. Switching transient power, dBm</li> </ol>

Measurement Method	n	Results Returned
<p>Multiple Offsets Switching -or- Multiple Offsets Modulation Discrete Mode</p>	<p>n=1 (or not specified)</p>	<p>Returns a list of values for the modulation spectrum at all the offsets (lower and upper.) This is followed by the switching transients results at all the offsets (lower and upper). Note that the carrier is considered offset zero (0) and is the first set of results sent. Four values are provided for each of the offsets (including the carrier), in this order:</p> <ol style="list-style-type: none"> <li>1. Negative offset(a) - power relative to carrier (dB)</li> <li>2. Negative offset(a) - absolute average power (dBm)</li> <li>3. Positive offset(a) - power relative to carrier (dB)</li> <li>4. Positive offset(a) - absolute average power (dBm)</li> </ol> <p>Values for all possible offsets are sent. Zeros are sent for offsets that have not been defined. The total number of values sent (120) = (4 results/offset) × (15 offsets) × (2 measurement types - modulation &amp; switching)</p> <p>Carrier - modulation measurement values Offset 1 - modulation measurement values ... Offset 14 - modulation measurement values Carrier - switching transients measurement values Offset 1 - switching transients measurement values ... Offset 14- switching transients measurement values</p> <p>This measurement defaults to modulation measurements and not switching measurements. If you want to return the switching measurement values, you must change that default condition and use FETCh or READ to return values, rather than MEASure.</p> <p>NOTE: When using custom modulation and switching offsets the maximum number of measured values returned is:</p> <p>13 modulation offsets + 0 Hz carrier 4 switching offsets + 0 Hz carrier</p>
<p>Multiple Offsets Modulation Sweep Mode</p>	<p>n=1 (or not specified)</p>	<p>Returns measurement results of the closest point to the limit line:</p> <ol style="list-style-type: none"> <li>1. Frequency</li> <li>2. Offset frequency from carrier frequency</li> <li>3. Power in dBm</li> <li>4. delta from limit (dB)</li> <li>5. delta from reference (dB)</li> </ol>
<p>Single Offset</p>	<p>2</p>	<p>Returns floating point numbers (in dBm) of the captured trace data. It contains N data points of the “spectrum due to modulation” signal, where N is the specified number of samples.</p>

<b>Measurement Method</b>	<b>n</b>	<b>Results Returned</b>
Single Offset	3	Returns floating point numbers (in dBm) of the captured trace data. It contains N data points of the “spectrum due to switching transients” signal, where N is the specified number of samples.
Multiple Offsets Modulation, Sweep Mode	4	Returns floating point numbers (in dBm) of the sweep spectrum of modulation.
Multiple Offsets Modulation, Sweep Mode	5	Returns floating point numbers (in dBm) of the limit trace.



<b>Measurement Method</b>	<b>n</b>	<b>Results Returned</b>
<p>Meas Type = Mod &amp; Switch AND Meas Method = Multi-Offset</p> <p>- or -</p> <p>Meas Type = Modulation AND Meas Method = Multi-Offset</p> <p>- or -</p> <p>Meas Type = Switching AND Meas Method = Multi-Offset</p> <p>- or -</p> <p>Meas Type = Full Frame Mod (FAST)</p>	<p>6</p>	<p>Relative level to the test limit, and test limit itself for both modulation and switching transient measurements.</p> <p>Returns a list of relative level to the test limit, the relative test limit and the absolute test limit for all the offset frequencies. The relative level to the test limit is returned for both lower and upper offsets. Four values are returned for each offset in the following order:</p> <ol style="list-style-type: none"> <li>1. Relative level to the test limit (dB) at the negative offset frequency</li> <li>2. Relative level to the test limit (dB) at the positive offset frequency</li> <li>3. Relative test limit used (dB)</li> <li>4. Absolute test limit used (dBm)</li> </ol> <p>Values for all possible offsets are returned.</p> <p>The carrier frequency is considered offset zero (0.0 Hz) and is the first set of values returned. Zeros are returned for offsets that have not been defined.</p> <p>Zeros are returned for the measurement that was not performed. For example, if Meas Type is Modulation, all switching transients measurement results will be 0.0.</p> <p>The total number of values returned is:  <math>120 = (4 \text{ results / offset}) * (15 \text{ offset frequencies}) * (2 \text{ measurement types})</math></p> <p>Carrier (Offset A) – modulation measurement results            Offset 1 (Offset B) - modulation measurement results            . . . . .            Offset 14 (Offset O) - modulation measurement results            Carrier (Offset A)– switching transients measurement results            Offset 1 (Offset B) – switching transients measurement results            . . . . .            Offset 14 (Offset O) – switching transients measurement results</p>

## GMSK Phase & Frequency Error Measurement

This measures the modulation quality of the transmitter by checking phase and frequency accuracy. You must be in the EDGE, GSM mode to use these commands. Use INSTRument:SElect to set the mode.

The general functionality of CONFigure, FETCh, MEASure, and READ are described at the beginning of this section. See the SENSE:PFERror commands for more measurement related commands.

```
:CONFigure:PFERror  
:INITiate:PFERror?  
:FETCh:PFERror [n] ?  
:READ:PFERror [n] ?  
:MEASure:PFERror [n] ?
```

Front Panel

Access: **Measure, Phase & Freq**

After the measurement is selected, press **Restore Meas Defaults** to restore factory defaults.

### Measurement Results Available

<b>n</b>	<b>Results Returned</b>
0	Returns unprocessed I/Q trace data, as a series of trace point values, in volts. The I values are listed first in each pair, using the 0 through even-indexed values. The Q values are the odd-indexed values,

n	Results Returned
n=1 (or not specified)	<p>Returns the following scalar results:</p> <ol style="list-style-type: none"> <li>1. <b>RMS phase error</b> is a floating point number (in degrees) of the rms phase error between the measured phase and the ideal phase. The calculation is based on symbol decision points and points halfway between symbol decision points (i.e. 2 points/symbol). If averaging is on, this is the average of the individual rms measurements.</li> <li>2. <b>Peak phase error</b> is a floating point number (in degrees) of the peak phase error of all the symbol decision points. rms averaging does not affect this calculation.</li> <li>3. <b>Peak phase symbol</b> is a floating point number (in symbols) representing the symbol number at which the peak phase error occurred. Averaging does not affect this calculation.</li> <li>4. <b>Frequency error</b> is a floating point number (in Hz) of the frequency error in the measured signal. This is the difference between the measured phase trajectory and the reference phase trajectory.</li> <li>5. <b>I/Q origin offset</b> is a floating point number (in dB) of the I and Q error (magnitude squared) offset from the origin.</li> <li>6. <b>Phase sample</b> is a floating point number (in units of bits) representing the time between samples. It is used in querying phase error vector traces.</li> <li>7. <b>Bit 0 offset</b> is an integer number for the sample point in a phase error vector trace that represents the bit 0 (zero) decision point. The sample points in the trace are numbered 0 to N.</li> <li>8. <b>Sync start</b> is an integer number for the bit number, within the data bits trace, that represents the start of the sync word.</li> <li>9. <b>Time sample</b> is a floating point number (in seconds) of the time between samples. It is used in querying time domain traces. For the n=0 trace, of acquired I/Q pairs, this is the time between pairs.</li> <li>10. <b>Trigger to T0</b> is a floating point number (in seconds) of the time interval between the trigger point and <math>T_0</math>. <math>T_0</math> is the transition time from symbol 13 to symbol 14 of the midamble training sequence for each time slot.</li> </ol>
2, and <b>Multi View</b> is the selected view	Returns a series of floating point numbers (in degrees) that represent each sample in the phase error trace. The first number is the symbol 0 decision point and there are 10 points per symbol. Therefore, decision points are at 0, 10, 20, etc.
3, and <b>Multi View</b> is the selected view	Returns a series of floating point numbers (in degrees) that represent each sample in the phase error with frequency trace. Phase error with frequency is the error vector between the measured phase (that has not had frequency compensation) and the ideal reference phase. The calculation is based on symbol decision points and points halfway between symbol decision points (i.e. 2 points/symbol). The first number is the symbol 0 decision point and there are 10 points per symbol. Therefore, decision points are at 0, 10, 20, etc.

<b>n</b>	<b>Results Returned</b>
4, and <b>Multi View</b> is the selected view	Returns a series of floating point numbers that represent each sample in the log magnitude trace of the original time record. Each number represents a value (in dBm) of the time record.
5, and <b>IQ Measured Polar Vector</b> is the selected view	<p>Returns a series of floating point numbers that alternately represent I and Q pairs of the corrected measured trace. The magnitude of each I and Q pair are normalized to 1.0. The first number is the in-phase (I) sample of symbol 0 decision point and the second is the quadrature-phase (Q) sample of symbol 0 decision point. As in the rms phase error, there are ten points per symbol, so that:</p> <p>1st number = I of the symbol 0 decision point            2nd number = Q of the symbol 0 decision point            ..            10th number = Q of the symbol 0 decision point            11th number = I of the symbol 1 decision point            12th number = Q of the symbol 1 decision point            ..            10 × Nth number = Q of the symbol N decision point</p>
6, and <b>Multi View</b> is the selected view	Returns a series of logical values (0 or 1) that represent the demodulated bit value of the measured waveform. The first number is the symbol 0 decision point and there are 10 points per symbol. Therefore, decision points are at 0, 10, 20, etc.

## GMSK Power vs. Time Measurement

For E4406A this measures the average power during the “useful part” of the burst comparing the power ramp to required timing mask. You must be in EDGE, GSM, 1xEV-DO or Service mode to use these commands. Use INSTRument:SElect to set the mode.

For PSA this measures the average power during the “useful part” of the burst comparing the power ramp to required timing mask. You must be in GSM(w/EDGE), or 1xEV-DO mode to use these commands. Use INSTRument:SElect to set the mode.

The general functionality of CONFigure, FETCh, MEASure, and READ are described at the beginning of this section. See the SENSE:PVTime commands for more measurement related commands.

- :CONFigure:PVTime**
- :INITiate:PVTime**
- :FETCh:PVTime [n] ?**
- :READ:PVTime [n] ?**
- :MEASure:PVTime [n] ?**

Front Panel

Access: **Measure, Power vs Time**

After the measurement is selected, press **Restore Meas Defaults** to restore factory defaults.

History: Modified in version A.05.00..

### Measurement Results Available

<b>n</b>	<b>Results Returned</b>
0	Returns unprocessed I/Q trace data, as a series of trace point values, in volts. The I values are listed first in each pair, using the 0 through even-indexed values. The Q values are the odd-indexed values.

n	Results Returned
n=1 (or not specified)	<p>Returns the following scalar results:</p> <ol style="list-style-type: none"> <li>1. <b>Sample time</b> is a floating point number that represents the time between samples when using the trace queries (n=0,2,etc.).</li> <li>2. <b>Power of single burst</b> is the mean power (in dBm) across the useful part of the selected burst in the most recently acquired data, or in the last data acquired at the end of a set of averages. If averaging is on, the power is for the last burst.</li> <li>3. <b>Power averaged</b> is the power (in dBm) of N averaged bursts, if averaging is on. The power is averaged across the useful part of the burst. Average <i>m</i> is a single burst from the acquired trace. If there are multiple bursts in the acquired trace, only one burst is used for average <i>m</i>. This means that N traces are acquired to make the complete average. If averaging is off, the value of <b>power averaged</b> is the same as the <b>power single burst</b> value.</li> <li>4. <b>Number of samples</b> is the number of data points in the captured signal. This number is useful when performing a query on the signal (i.e. when n=0,2,etc.).</li> <li>5. <b>Start point of the useful part of the burst</b> is the index of the data point at the start of the useful part of the burst</li> <li>6. <b>Stop point of the useful part of the burst</b> is the index of the data point at the end of the useful part of the burst</li> <li>7. Index of the data point where <math>T_0</math> occurred.</li> <li>8. <b>Burst width of the useful part of the burst</b> is the width of the burst measured at -3dB below the mean power in the useful part of the burst.</li> <li>9. <b>Maximum value</b> is the maximum value of the most recently acquired data (in dBm).</li> <li>10. <b>Minimum value</b> is the minimum value of the most recently acquired data (in dBm).</li> <li>11. <b>Burst search threshold</b> is the value (in dBm) of the threshold where a valid burst is identified, after the data has been acquired.</li> <li>12. <b>IQ point delta</b> is the number of data points offset that are internally applied to the useful data in traces <i>n</i>=2,3,4. You must apply this correction value to find the actual location of the <b>Start</b>, <b>Stop</b>, or <math>T_0</math> values.</li> </ol>

<b>n</b>	<b>Results Returned</b>
<p>n=1 (or not specified) 1xEV-DO or W-CDMA mode</p>	<p>Returns the following scalar results:</p> <ol style="list-style-type: none"> <li>1. <b>Sample time</b> is a floating point number that represents the time between samples when using the trace queries (where n = 0, 2, etc.).</li> <li>2. <b>Power of single burst</b> is the mean power (in dBm) across the useful part of the selected burst in the most recently acquired data, or in the last data acquired at the end of a set of averages. If averaging is on, the power is for the last burst.</li> <li>3. <b>Power averaged</b> is the power (in dBm) of N averaged bursts, if averaging is on. The power is averaged across the useful part of the burst. Average <i>m</i> is a single burst from the acquired trace. If there are multiple bursts in the acquired trace, only one burst is used for average <i>m</i>. This means that N traces are acquired to make the complete average. If averaging is off, the value of <b>power averaged</b> is the same as the <b>power single burst</b> value.</li> <li>4. <b>Number of samples (N)</b> is the number of data points in the captured signal. This number is useful when performing a query on the signal (i.e. when n = 0, 2, etc.).</li> <li>5. <b>Start point of the useful part of the burst</b> is the index of the data point at the start of the useful part of the burst</li> <li>6. <b>Stop point of the useful part of the burst</b> is the index of the data point at the end of the useful part of the burst</li> <li>7. Index of the data point where <math>T_0</math> occurred.</li> <li>8. <b>Burst width of the useful part of the burst</b> is the width of the burst measured at -3dB below the mean power in the useful part of the burst.</li> <li>9. <b>Maximum value</b> is the maximum value of the most recently acquired data (in dBm).</li> <li>10. <b>Minimum value</b> is the minimum value of the most recently acquired data (in dBm).</li> <li>11. <b>Burst search threshold</b> is the value (in dBm) of the threshold where a valid burst is identified, after the data has been acquired.</li> <li>12. <b>Averaged number (N)</b> is used to average the measurement results.</li> <li>13. <b>First position in index to exceed the limit (N)</b> is ?</li> <li>14. Reserved for future use, returns -999.0.</li> <li>15. Reserved for future use, returns -999.0.</li> <li>16. Reserved for future use, returns -999.0.</li> <li>17. <b>Absolute power in the region A (dBm)</b></li> <li>18. <b>Absolute power in the region B (dBm)</b></li> <li>19. <b>Absolute power in the region C (dBm)</b></li> <li>20. <b>Absolute power in the region D (dBm)</b></li> <li>21. <b>Absolute power in the region E (dBm)</b></li> <li>22. <b>Relative power in the region A (dB)</b></li> <li>23. <b>Relative power in the region B (dB)</b></li> <li>24. <b>Relative power in the region C (dB)</b></li> <li>25. <b>Relative power in the region D (dB)</b></li> </ol>

n	Results Returned
n=1 (or not specified) (cont.)  1xEV-DO or W-CDMA mode	26. <b>Relative power in the region E (dB)</b> 27. <b>Maximum absolute power in the region A (dBm)</b> 28. <b>Maximum absolute power in the region B (dBm)</b> 29. <b>Maximum absolute power in the region C (dBm)</b> 30. <b>Maximum absolute power in the region D (dBm)</b> 31. <b>Maximum absolute power in the region E (dBm)</b> 32. <b>Maximum relative power in the region A (dB)</b> 33. <b>Maximum relative power in the region B (dB)</b> 34. <b>Maximum relative power in the region C (dB)</b> 35. <b>Maximum relative power in the region D (dB)</b> 36. <b>Maximum relative power in the region E (dB)</b> 37. <b>Minimum absolute power in the region A (dBm)</b> 38. <b>Minimum absolute power in the region B (dBm)</b> 39. <b>Minimum absolute power in the region C (dBm)</b> 40. <b>Minimum absolute power in the region D (dBm)</b> 41. <b>Minimum absolute power in the region E (dBm)</b> 42. <b>Minimum relative power in the region A (dB)</b> 43. <b>Minimum relative power in the region B (dB)</b> 44. <b>Minimum relative power in the region C (dB)</b> 45. <b>Minimum relative power in the region D (dB)</b> 46. <b>Minimum relative power in the region E (dB)</b>
2	Returns trace point values of the entire captured I/Q trace data. These data points are floating point numbers representing the power of the signal (in dBm). There are N data points, where N is the <b>number of samples</b> . The period between the samples is defined by the <b>sample time</b> .
3	Returns data points representing the upper mask (in dBm).
4	Returns data points representing the lower mask (in dBm).
6 W-CDMA mode	Returns 5 comma-separated scalar values of the pass/fail (0.0=passed, or 1.0=failed) results determined by testing the upper mask.
7 W-CDMA mode	Returns 5 comma-separated scalar values of the pass/fail (0.0=passed, or 1.0=failed) results determined by testing the lower mask:
7 EDGE, GSM, Service mode (E4406A only)  GSM (/EDGE) mode (PSA only)	Returns power level values for the 8 slots in the current frame (in dBm).



## Sensor Measurement

This checks the output of three sensors in the RF and IF circuitry. You must be in the Service mode to use these commands. Use `INSTRument:SElect` to set the mode.

The general functionality of `CONFigure`, `FETCh`, `MEASure`, and `READ` are described at the beginning of this section.

**:CONFigure:SENSors**

**:INITiate:SENSors**

**:FETCh:SENSors [n] ?**

**:READ:SENSors [n] ?**

**:MEASure:SENSors [n] ?**

Front Panel

Access: With Service Mode selected, **Measure, Sensors**

### Measurement Results Available

<b>n</b>	<b>Results Returned</b>
0	Not valid
n=1 (or not specified)	Returns the following scalar results: <ol style="list-style-type: none"> <li><b>IF signal amplitude</b> is the ADC value for the detected 21.4 MHz IF signal at the input to the analog IF.</li> <li><b>Calibration Oscillator Level</b> is a floating point number (is not implemented, currently returns a zero).</li> <li><b>RF temperature</b> is a floating point number for the current temperature in the RF section (in degrees Celsius).</li> </ol>

## Spectrum (Frequency Domain) Measurement

For E4406A this measures the amplitude of your input signal with respect to the frequency. It provides spectrum analysis capability using FFT (fast Fourier transform) measurement techniques. You must select the appropriate mode using INSTRument:SElect, to use these commands.

For PSA this measures the amplitude of your input signal with respect to the frequency. It provides spectrum analysis capability using FFT (fast Fourier transform) measurement techniques. You must be in the Basic, cdmaOne, cdma2000, 1xEV-DO, W-CDMA, GSM (w/EDGE), NADC, or PDC mode to use these commands. Use INSTRument:SElect, to select the mode.

The general functionality of CONFigure, FETCh, MEASure, and READ are described at the beginning of this section. See the SENSE:SPECTrum commands for more measurement related commands.

```
:CONFigure:SPECTrum  
:INITiate:SPECTrum  
:FETCh:SPECTrum[n]?  
:READ:SPECTrum[n]?  
:MEASure:SPECTrum[n]?
```

Front Panel

Access: **Measure, Spectrum (Freq Domain)**

After the measurement is selected, press **Restore Meas Defaults** to restore factory defaults.

### Measurement Results Available

n	Results Returned
0	Returns unprocessed I/Q trace data, as a series of trace point values, in volts. The I values are listed first in each pair, using the 0 through even-indexed values. The Q values are the odd-indexed values.

n	Results Returned
n=1 (or not specified)	<p>Returns the following scalar results:</p> <ol style="list-style-type: none"> <li>1. <b>FFT peak</b> is the FFT peak amplitude.</li> <li>2. <b>FFT frequency</b> is the FFT frequency of the peak amplitude.</li> <li>3. <b>FFT points</b> is the Number of points in the FFT spectrum.</li> <li>4. <b>First FFT frequency</b> is the frequency of the first FFT point of the spectrum.</li> <li>5. <b>FFT spacing</b> is the frequency spacing between the FFT points of the spectrum.</li> <li>6. <b>Time domain points</b> is the number of points in the time domain trace used for the FFT. The number of points doubles if the data is complex instead of real. See the time domain scaler description below.</li> <li>7. <b>First time point</b> is the time of the first time domain point, where time zero is the trigger event.</li> <li>8. <b>Time spacing</b> is the time spacing between the time domain points. The time spacing value doubles if the data is complex instead of real. See the time domain scaler description below.</li> <li>9. <b>Time domain</b> returns a 1 if time domain is complex (I/Q) and complex data will be returned. It returns a 0 if the data is real. (raw ADC samples) When this value is 1 rather than 0 (complex vs. real data), the time domain points and the time spacing scalers both increase by a factor of two.</li> <li>10. <b>Scan time</b> is the total scan time of the time domain trace used for the FFT. The total scan time = (time spacing) X (time domain points – 1)</li> <li>11. <b>Current average count</b> is the current number of data measurements that have already been combined, in the averaging calculation.</li> </ol>
2, <b>Service mode only</b>	Returns the trace data of the log-magnitude versus time. (That is, the RF envelope.)
3	Returns the I and Q trace data. It is represented by I and Q pairs (in volts) versus time.
4	Returns spectrum trace data. That is, the trace of log-magnitude versus frequency. (The trace is computed using a FFT.)
5, <b>Service mode only</b>	Returns the averaged trace data of log-magnitude versus time. (That is, the RF envelope.)
6	Not used.
7	Returns the averaged spectrum trace data. That is, the trace of the averaged log-magnitude versus frequency.
8	Not used.
9, <b>Service mode only</b>	Returns a trace containing the shape of the FFT window.

<b>n</b>	<b>Results Returned</b>
10, <b>Service</b> mode only	Returns trace data of the phase of the FFT versus frequency.
11, cdma2000, 1xEV-DO, W-CDMA, Basic modes only	Returns linear spectrum trace data values in Volts RMS.
12, cdma2000, 1xEV-DO, W-CDMA, Basic modes only	Returns averaged linear spectrum trace data values in Volts RMS.

## Timebase Frequency Measurement

The general functionality of **CONFigure**, **FETCh**, **MEASure**, and **READ** are described at the beginning of this section. See the **SENSe:TBFrequency** commands for more measurement related commands.

You must be in the Service mode to use these commands. Use **INSTrument:SElect** to set the mode.

**:CONFigure:TBFrequency**

**:INITiate:TBFrequency**

**:FETCh:TBFrequency [n] ?**

**:READ:TBFrequency [n] ?**

**:MEASure:TBFrequency [n] ?**

Remarks: For auto adjustment of the internal frequency reference (10 MHz timebase), use the **CALibration:FREquency:REference:AADJust** command after this measurement has been selected.

Front Panel

Access: **Measure, Timebase Freq**

After the measurement is selected, press **Restore Meas Defaults** to restore factory defaults.

### Measurement Results Available

<b>n</b>	<b>Results Returned</b>
0	Not valid
n=1 (or not specified)	Returns scalar results: <ol style="list-style-type: none"> <li>1. RF input average amplitude</li> <li>2. Average frequency error</li> <li>3. Adjustment in process (returns 1 if an adjustment is being performed, returns 0 if no adjustment is in process)</li> </ol>
2	Frequency error stripchart trace data.

## GMSK Transmit Band Spurs Measurement

This measures the spurious emissions in the transmit band relative to the channel power in the selected channel. You must be in the EDGE, GSM mode to use these commands. Use INSTRument:SElect to set the mode.

The general functionality of CONFigure, FETCh, MEASure, and READ are described at the beginning of this section. See the SENSE:TSPur commands for more measurement related commands.

**:CONFigure:TSPur**

**:INITiate:TSPur**

**:FETCh:TSPur [n] ?**

**:READ:TSPur [n] ?**

**:MEASure:TSPur [n] ?**

History:           Version A.03.00 or later

Front Panel

Access:           **Measure, Tx Band Spurs**

After the measurement is selected, press **Restore Meas Defaults** to restore factory defaults.

### Measurement Results Available

<b>n</b>	<b>Results Returned</b>
0	Returns unprocessed I/Q trace data, as a series of trace point values, in volts. The I values are listed first in each pair, using the 0 through even-indexed values. The Q values are the odd-indexed values.
n=1 (or not specified)	Returns scalar results: 1. The worst spur's frequency difference from channel center frequency (in MHz) 2. The worst spur's amplitude difference from the limit (in dB) 3. The worst spur's amplitude difference from the mean transmit power (in dB)
2	Returns the current trace data (401 point real number comma separated list).

## GMSK Transmit Power Measurement

This measures the power in the channel. It compares the average power of the RF signal burst to a specified threshold value. You must be in the EDGE, GSM mode to use these commands. Use INSTRument:SElect to set the mode.

The general functionality of CONFigure, FETCh, MEASure, and READ are described at the beginning of this section. See the SENSE:TXPower commands for more measurement related commands.

```
:CONFigure:TXPower
:INITiate:TXPower
:FETCh:TXPower [n] ?
:READ:TXPower [n] ?
:MEASure:TXPower [n] ?
```

Front Panel

Access: **Measure, Transmit Power**

After the measurement is selected, press **Restore Meas Defaults** to restore factory defaults.

### Measurement Results Available

<b>n</b>	<b>Results Returned</b>
0	Returns unprocessed I/Q trace data, as a series of trace point values, in volts. The I values are listed first in each pair, using the 0 through even-indexed values. The Q values are the odd-indexed values.

n	Results Returned
n=1 (or not specified)	<p>Returns the following scalar results:</p> <ol style="list-style-type: none"> <li>1. <b>Sample time</b> is a floating point number representing the time between samples when using the trace queries (n=0,2,etc).</li> <li>2. <b>Power</b> is the mean power (in dBm) of the power above the threshold value. If averaging is on, the power is for the latest acquisition.</li> <li>3. <b>Power averaged</b> is the threshold power (in dBm) for N averages, if averaging is on. An average consists of N acquisitions of data which represents the current trace. If averaging is off, the value of <b>power averaged</b> is the same as the <b>power</b> value.</li> <li>4. <b>Number of samples</b> is the number of data points in the captured signal. This number is useful when performing a query on the signal (i.e. when n=0,2,etc.).</li> <li>5. <b>Threshold value</b> is the threshold (in dBm) above which the power is calculated.</li> <li>6. <b>Threshold points</b> is the number of points that were above the threshold and were used for the power calculation.</li> <li>7. <b>Maximum value</b> is the maximum of the most recently acquired data (in dBm).</li> <li>8. <b>Minimum value</b> is the minimum of the most recently acquired data (in dBm).</li> </ol>
2	<p>Returns trace point values of the entire captured trace data. These data points are floating point numbers representing the power of the signal (in dBm). There are N data points, where N is the <b>number of samples</b>. The period between the samples is defined by the <b>sample time</b>.</p>



## Waveform (Time Domain) Measurement

For E4406A this measures the amplitude of your input signal with respect to the frequency. It provides spectrum analysis capability using FFT (fast Fourier transform) measurement techniques. You must select the appropriate mode using INSTRUMENT:SELEct, to use these commands.

For PSA this measures the amplitude of your input signal with respect to the frequency. It provides spectrum analysis capability using FFT (fast Fourier transform) measurement techniques. You must be in the Basic, cdmaOne, cdma2000, 1xEV-DO, W-CDMA, GSM (w/EDGE), NADC, or PDC mode to use these commands. Use INSTRUMENT:SELEct, to select the mode.

The general functionality of CONFigure, FETCh, MEASure, and READ are described at the beginning of this section. See the SENSE:WAVEform commands for more measurement related commands.

**:CONFigure:WAVEform**  
**:INITiate:WAVEform**  
**:FETCh:WAVEform[n]?**  
**:READ:WAVEform[n]?**  
**:MEASure:WAVEform[n]?**

Front Panel

Access: **Measure, Waveform (Time Domain)**

After the measurement is selected, press **Restore Meas Defaults** to restore factory defaults.

### Measurement Results Available

<b>n</b>	<b>Results Returned</b>
0 (see also 5)	Returns unprocessed I/Q trace data, as a series of trace point values, in volts. The I values are listed first in each pair, using the 0 through even-indexed values. The Q values are the odd-indexed values.

n	Results Returned
n=1 (or not specified)	<p>Returns the following scalar results:</p> <ol style="list-style-type: none"> <li>1. <b>Sample time</b> is a floating point number representing the time between samples when using the trace queries (n=0,2,etc).</li> <li>2. <b>Mean power</b> is the mean power (in dBm). This is either the power across the entire trace, or the power between markers if the markers are enabled. If averaging is on, the power is for the latest acquisition.</li> <li>3. <b>Mean power averaged</b> is the power (in dBm) for N averages, if averaging is on. This is either the power across the entire trace, or the power between markers if the markers are enabled. If averaging is on, the power is for the latest acquisition. If averaging is off, the value of the mean power averaged is the same as the value of the mean power.</li> <li>4. <b>Number of samples</b> is the number of data points in the captured signal. This number is useful when performing a query on the signal (i.e. when n=0,2,etc.).</li> <li>5. <b>Peak-to-mean ratio</b> has units of dB. This is the ratio of the maximum signal level to the mean power. Valid values are only obtained with averaging turned off. If averaging is on, the peak-to-mean ratio is calculated using the highest peak value, rather than the displayed average peak value.</li> <li>6. <b>Maximum value</b> is the maximum of the most recently acquired data (in dBm).</li> <li>7. <b>Minimum value</b> is the minimum of the most recently acquired data (in dBm).</li> </ol>
2	Returns trace point values of the entire captured signal envelope trace data. These data points are floating point numbers representing the power of the signal (in dBm). There are N data points, where N is the <b>number of samples</b> . The period between the samples is defined by the <b>sample time</b> .
3, Option B7C with cdma2000, W-CDMA, Basic modes only (E4406A only)	Returns magnitude values of the time data in Volts peak.
4, Option B7C with cdma2000, W-CDMA, Basic modes only (E4406A only)	Returns values of phase data in degrees.

---

## READ Subsystem

The READ? commands are used with several other commands and are documented in the section on the “[MEASure Group of Commands](#)” on [page 332](#).

### Initiate and Read Measurement Data

**:READ: <measurement> [n] ?**

A READ? query must specify the desired measurement. It will cause a measurement to occur without changing any of the current settings and will return any valid results. The code number n selects the kind of results that will be returned. The available measurements and data results are described in the “[MEASure Group of Commands](#)” on [page 332](#).

---

## SENSe Subsystem

These commands are used to set the instrument state parameters so that you can measure a particular input signal. Some SENSe commands are only for use with specific measurements found under the MEASURE key menu or the “MEASure Group of Commands” on page 519. The measurement must be active before you can use these commands.

The SCPI default for the format of any data output is ASCII. The format can be changed to binary with FORMat:DATA which transports faster over the bus.

### Baseband I/Q Commands (E4406A only)

#### Baseband I/Q - Select I/Q Power Range

```
[[:SENSe]:POWER:IQ:RANGE[:UPPer] <power> [DBM|DBMV|W  
[:SENSe]:POWER:IQ:RANGE[:UPPer] ?
```

Selects maximum total power expected from unit under test at test port when I or Q port is selected.

Range: For 50 Ohms:

13.0, 7.0, 1.0, or -5.1 dBm  
60.0, 54.0, 48.0, or 41.9 dBmV  
0.02, 0.005, 0.0013, or 0.00031 W

For 600 Ohms:

2.2, -3.8, -9.8, or -15.8 dBm  
60.0, 54.0, 48.0, or 41.9 dBmV  
0.0017, 0.00042, 0.0001, or 0.000026 W

For 1 M Ohm:

Values for 1 M Ohm vary according to selected reference impedance.

Default Units: DBM

Remarks: You must be in the Basic, W-CDMA, cdma2000, or EDGE with GSM mode to use this command. Use INSTRument:SElect to set the mode.

History: Added revision A.05.00 for B, WC, C2  
Added revision A.06.00 for E

#### Baseband I/Q - Select I/Q Voltage Range

```
[[:SENSe]:VOLTage:IQ:RANGE[:UPPer] <level>
```

**[ :SENSe ] :VOLTage :IQ :RANGe [ :UPPer ] ?**

Selects upper voltage range when I or Q port is selected. This setting helps set the gain which is generated in the variable gain block of the baseband IQ board to improve dynamic range.

Range: 1.0, 0.5, 0.25, or 0.125 volts

Default Units: V

Remarks: You must be in the Basic, W-CDMA, cdma2000, or EDGE with GSM mode to use this command. Use INSTRument:SElect to set the mode.

History: Added revision A.05.00 for B, WC, C2  
Added revision A.06.00 for E

## Channel Commands

### Select the ARFCN—Absolute RF Channel Number

**[ :SENSe ] :CHANnel :ARFCn | RFChannel <integer>**

**[ :SENSe ] :CHANnel :ARFCn | RFChannel ?**

Set the analyzer to a frequency that corresponds to the ARFCN (Absolute RF Channel Number).

Factory Preset: 38

Range:           0 to 124, and 975 to 1023 for E-GSM  
                  1 to 124 for P-GSM  
                  0 to 124, and 955 to 1023 for R-GSM  
                  512 to 885 for DCS1800  
                  512 to 810 for PCS1900  
                  259 to 293 for GSM450  
                  306 to 340 for GSM480  
                  438 to 511 for GSM700  
                  128 to 251 for GSM850

Remarks:       You must be in the GSM, EDGE mode to use this command. Use INSTRument:SElect to set the mode.

Global to the current mode.

History:        E4406A:  
                  Version A.03.00 or later

Front Panel

Access:        **FREQUENCY Channel, ARFCN**

### Select the Lowest ARFCN

**[ :SENSe ] :CHANnel :ARFCn | RFChannel :BOTTom**

Set the analyzer to the frequency of the lowest ARFCN (Absolute RF Channel Number) of the selected radio band.

Factory Preset: 975 for E-GSM

1 for P-GSM

955 for R-GSM

512 for DCS1800

512 PCS1900

259 GSM450

306 GSM480

438 GSM700

128 GSM850

Remarks: You must be in the GSM, EDGE mode to use this command. Use INSTRUMENT:SElect to set the mode.

Global to the current mode.

History: E4406A:  
Version A.03.00 or later

Front Panel

Access: **FREQUENCY Channel, BMT Freq**

### Select the Middle ARFCN

**[ :SENSe ] :CHANnel :ARFCn | RFChannel :MIDDLE**

Set the analyzer to the frequency of the middle ARFCN (Absolute RF Channel Number) of the selected radio band.

Factory Preset: 38 for E-GSM

63 for P-GSM

28 for R-GSM

699 for DCS1800

661 for PCS1900

276 for GSM450

323 for GSM480

474 for GSM 700

189 for GSM850

Remarks: You must be in the GSM, EDGE mode to use this command. Use INSTRUMENT:SElect to set the mode.

Global to the current mode.

History: E4406A:  
Version A.03.00 or later

Front Panel

Access: **FREQUENCY Channel, BMT Freq**

### Select the Highest ARFCN

**[ :SENSe ] :CHANnel :ARFCn | RFChannel :TOP**

Set the analyzer to the frequency of the highest ARFCN (Absolute RF Channel Number) of the selected radio band.

Factory Preset: 124 for E-GSM

124 for P-GSM

124 for R-GSM

885 for DCS1800

810 for PCS1900

293 for GSM450

340 for GSM480

511 for GSM700

251 for GSM850

Remarks: You must be in the GSM, EDGE mode to use this command. Use INSTRument:SElect to set the mode.  
Global to the current mode.

History: E4406A:  
Version A.03.00 or later

Front Panel  
Access: **FREQUENCY Channel, BMT Freq**

### Channel Burst Type

**[ :SENSe ] :CHANnel :BURSt NORMal | SYNC | ACCess**

**[ :SENSe ] :CHANnel :BURSt ?**

Set the burst type that the analyzer will search for and to which it will sync. This only applies with normal burst selected.

NORMal: Traffic Channel (TCH) and Control Channel (CCH)

SYNC: Synchronization Channel (SCH)

ACCess: Random Access Channel (RACH)

Remarks: You must be in the GSM, EDGE mode to use this command. Use INSTRument:SElect to set the mode.  
Global to the current mode.

Front Panel  
Access: **FREQUENCY Channel, Burst Type**



### Time Slot number

**[ :SENSE ] :CHANnel :SLOT <integer>**

**[ :SENSE ] :CHANnel :SLOT?**

Select the slot number that you want to measure.

in GSM, EDGE mode the measurement frame is divided into the eight expected measurement timeslots.

Factory Preset: 0 for GSM, EDGE, PDC mode

1 for NADC mode

Range: 0 to 5 for PDC mode

1 to 6 for NADC mode

0 to 7 for GSM, EDGE mode

Remarks: You must be in GSM, EDGE, NADC, or PDC mode to use this command. Use INSTRUMENT:SELEct to set the mode.

Front Panel

Access: **Mode Setup, Radio, Frequency Hopping Repetition Factor**

### Time Slot Auto

**[ :SENSE ] :CHANnel :SLOT :AUTO OFF | ON | 0 | 1**

**[ :SENSE ] :CHANnel :SLOT :AUTO?**

Select auto or manual control for slot searching. The feature is only supported in external and frame trigger source modes. In external trigger mode when timeslot is set on, the demodulation measurement is made on the nth timeslot specified by the external trigger point + n timeslots, where n is the selected timeslot value 0 to 7. In frame trigger mode when timeslot is set on, then demodulation measurement is only made on the nth timeslot specified by bit 0 of frame reference burst + n timeslots, where n is the selected timeslot value 0 to 7 and where the frame reference burst is specified by Ref Burst and Ref TSC (Std) combination.

Factory Preset: ON, for NADC, PDC mode

OFF, for GSM, EDGE mode

Remarks: The command is only applicable for mobile station testing, device = MS.

You must be in GSM, EDGE, NADC, or PDC mode to use this command. Use INSTRUMENT:SELEct to set the

mode.

History: E4406A:  
Added GSM mode, version A.03.00 or later

### Training Sequence Code (TSC)

**[ :SENSe ] :CHANnel:TSCode <integer>**

**[ :SENSe ] :CHANnel:TSCode?**

Set the training sequence code to search for, with normal burst selected and TSC auto set to off.

Factory Preset: 0

Range: 0 to 7

Remarks: Global to the current mode.

You must be in the GSM, EDGE mode to use this command. Use INSTRument:SELEct to set the mode.

History: E4406A:  
Version A.03.00 or later

Front Panel

Access: **FREQUENCY Channel, TSC (Std)**

### Training Sequence Code (TSC) Auto

**[ :SENSe ] :CHANnel:TSCode:AUTO OFF | ON | 0 | 1**

**[ :SENSe ] :CHANnel:TSCode:AUTO?**

Select auto or manual control for training sequence code (TSC) search. With auto on, the measurement is made on the first burst found to have one of the valid TSCs in the range 0 to 7 (i.e. normal bursts only). With auto off, the measurement is made on the 1st burst found to have the selected TSC.

Factory Preset: AUTO

Remarks: Global to the current mode.

You must be in the GSM, EDGE mode to use this command. Use INSTRument:SELEct to set the mode.

Front Panel

Access: **FREQUENCY Channel, TSC (Std)**

## Signal Corrections Commands

### Correction for BTS RF Port External Attenuation

**[ :SENSE ] :CORREction:BTS [ :RF ] :LOSS <rel\_power>**

**[ :SENSE ] :CORREction:BTS [ :RF ] :LOSS?**

Set equal to the external attenuation used when measuring base transmission stations.

Factory Preset: 0.0 dB

Range:            -50 to 100.0 dB for GSM, EDGE  
                    -100.0 to 100.0 dB for cdma2000, W-CDMA, 1xEV-DO

Default Unit:    dB

Remarks:        Global to the current mode.

You must be in the GSM, EDGE, cdma2000, W-CDMA, or 1xEV-DO mode to use this command. Use INSTRUMENT:SElect to set the mode.

### Correction for MS RF Port External Attenuation

**[ :SENSE ] :CORREction:MS [ :RF ] :LOSS <rel\_power>**

**[ :SENSE ] :CORREction:MS [ :RF ] :LOSS?**

Set the correction equal to the external attenuation used when measuring mobile stations.

Factory Preset: 0.0 dB

Range:            -50 to 100.0 dB for cdmaOne, GSM, EDGE, iDEN  
                    -100.0 to 100.0 dB for cdma2000, W-CDMA, 1xEV-DO  
                    -50.0 to 50.0 dB for NADC, PDC

Default Unit:    dB

Remarks:        For E4406A you must be in the cdmaOne, GSM, EDGE (w/GSM), cdma2000, W-CDMA, iDEN, NADC, PDC, or 1xEV-DO mode to use this command. Use INSTRUMENT:SElect to set the mode.

For PSA you must be in the cdmaOne, GSM (w/EDGE), cdma2000, W-CDMA, NADC, PDC, or 1xEV-DO mode to use this command. Use INSTRUMENT:SElect to set the mode.

Value is global to the current mode.

## EDGE Error Vector Magnitude Measurement

Commands for querying the EDGE error vector magnitude measurement results and for setting to the default values are found in the “MEASure Group of Commands” on page 519. The equivalent front panel keys for the parameters described in the following commands, are found under the **Meas Setup** key, after the measurement has been selected from the **MEASURE** key menu.

History: For E4406A: the EEVM measurement was added in version A.04.00.

For ESA: the EEVM measurement was added in the GSM, EDGE personality version C.01.00.

### EDGE Error Vector Magnitude—Average Count

**[ :SENSe ] :EEVM:AVERAge:COUNT <integer>**

**[ :SENSe ] :EEVM:AVERAge:COUNT?**

Sets the number of data acquisitions that will be averaged. After the specified number of average counts, the average mode (termination control) setting determines the average action.

Factory Preset: 10

Range: 1 to 10,000 for VSA, PSA

1 to 1000 for ESA

Remarks: You must be in GSM, EDGE mode to use this command. Use INSTRument:SElect to set the mode.

History: Added version A.04.00 and later

### EDGE Error Vector Magnitude—Averaging State

**[ :SENSe ] :EEVM:AVERAge [ :STATe ] OFF | ON | 0 | 1**

**[ :SENSe ] :EEVM:AVERAge [ :STATe ] ?**

Turn average on or off.

Factory Preset: ON for VSA, PSA

OFF for ESA

Remarks: You must be in GSM, EDGE mode to use this command. Use INSTRument:SElect to set the mode.

## EDGE Error Vector Magnitude—Averaging Termination Control

**[ :SENSe ] :EEVM:AVERage:TCONtrol EXPonential | REPEAT**

**[ :SENSe ] :EEVM:AVERage:TCONtrol?**

Select the type of termination control used for the averaging function. This determines the averaging action after the specified number of data acquisitions (average count) is reached.

**EXPonential** - After the average count has been reached, each successive data acquisition is exponentially weighted and combined with the existing average.

**REPEAT** - After reaching the average count, the averaging is reset and a new average is started.

Factory Preset: **EXPonential**

Remarks: You must be in GSM, EDGE mode to use this command.  
Use **INSTrument:SElect** to set the mode.

## EDGE Error Vector Magnitude—Burst Synchronization Source

For VSA, PSA:

**[ :SENSe ] :EEVM:BSYNc:SOURce RFBurst | TSEquence | NONE**

**[ :SENSe ] :EEVM:BSYNc:SOURce?**

Query only for ESA:

**[ :SENSe ] :EEVM:BSYNc:SOURce?**

Select the method of synchronizing the measurement to the bursts.

**RFBurst** - The burst synchronization approximates the start and stop of the useful part of the burst without demodulation of the burst. This type of synchronization has a frequency lock range of up to 9 kHz and allows you to demodulate RF bursts that do not have a training sequence.

**Training Sequence (TSEquence)** - The burst synchronization performs a demodulation of the burst and determines the start and stop of the useful part of the burst based on the midamble training sync sequence. This type of synchronization provides better noise immunity but has a smaller frequency lock range (~200 Hz).

**None** - The measurement is performed without searching burst.

Factory Preset: **TSEquence**

Remarks: You must be in GSM, EDGE mode to use this command.  
Use **INSTrument:SElect** to set the mode.

Remarks: On ESA Series analyzers, only Training Sequence (TSEquence) is supported. The query command will always return TSEquence as the result.

### EDGE Error Vector Magnitude—Droop Compensation

**[ :SENSe ] :EEVM:DROop OFF | ON | 0 | 1**

**[ :SENSe ] :EEVM:DROop?**

Turn droop compensation on or off. Droop compensation corrects amplitude variations across a burst. You may want to turn off this compensation so you can see the changes in the measured magnitude error. Droop can result from signal impairments such as a power amplifier problem.

Factory Preset: ON

Range: OFF, ON

Remarks: You must be in GSM, EDGE mode to use this command. Use INSTRument:SElect to set the mode.

### EDGE Error Vector Magnitude—Activate Extreme Limits

**[ :SENSe ] :EEVM:ELIMit OFF | ON | 0 | 1**

**[ :SENSe ] :EEVM:ELIMit?**

Turn EEVM extreme limits on or off. GSM 5.05 provides two sets of limits, called “Normal” and “Extreme”. Select “ON” to turn the extreme limits on. Select “OFF” to return limits to the “Normal” parameter after the “Extreme” limits have been selected.

Factory Preset: OFF

Range: OFF, ON

Remarks: You must be in GSM, EDGE mode to use this command. Use INSTRument:SElect to set the mode.

### EDGE Error Vector Magnitude—Freq Error Tolerance Range

**[ :SENSe ] :EEVM:FERRor:TRANge WIDE | NORMa1**

**[ :SENSe ] :EEVM:FERRor:TRANge?**

Name: Freq Error Tolerance Range

Key Path: Meas Setup, More 1 of 2

Factory Preset: WIDE  
 State Saved: Saved in instrument state.  
 Range: WIDE | NORMAl  
 Example: :SENSe:EEVM:FERRor:TRANge NORMAl

### EDGE Error Vector Magnitude—Points/Symbol Dots

**[ :SENSe ] :EEVM:SDOTs [ :STATe ] OFF | ON | 0 | 1**

**[ :SENSe ] :EEVM:SDOTs [ :STATe ] ?**

Activates or deactivates points/symbol dot display in polar view.

Factory Preset: ON

Range: OFF, ON

Remarks: You must be in GSM, EDGE mode to use this command.  
 Use INSTRument:SELEct to set the mode.

### EDGE Error Vector Magnitude—Points/Symbol Dots

**[ :SENSe ] :EEVM:TRACe:SDOTs <integer>**

**[ :SENSe ] :EEVM:TRACe:SDOTs?**

Selects the number of dots that will be displayed for each symbol.

Factory Preset: 5

Range: 1 to 5

Remarks: You must be in GSM, EDGE mode to use this command.  
 Use INSTRument:SELEct to set the mode.

### EDGE Error Vector Magnitude—Trigger Source

*For VSA, PSA:*

**[ :SENSe ] :EEVM:TRIGger:SOURce**

**EXTErnal [1] | EXTErnal2 | FRAME | IF | IMMEDIATE | RFBurst**

**[ :SENSe ] :EEVM:TRIGger:SOURce?**

*For ESA:*

**[ :SENSe ] :EEVM:TRIGger:SOURce**

**IMMEDIATE | RFBurst | EXTErnal | FRAME**

**[ :SENSe ] :EEVM:TRIGger:SOURce?**

Select the trigger source used to control the data acquisitions.

EXTernal 1 – front panel external trigger input

EXTernal 2 – rear panel external trigger input

EXTernal – rear panel external trigger input for ESA, front panel external input for VSA, PSA

IF – internal IF envelope (video) trigger

IMMediate – the next data acquisition is immediately taken, capturing the signal asynchronously (also called free run)

FRAMe – internal frame trigger from front panel input

RFBurst – wideband RF burst envelope trigger that has automatic level control for periodic burst signals

Factory Preset: IMMEDIATE for VSA,PSA BS

RFBurst for VSA,PSA MS

RFBurst for ESA

Remarks: You must be in GSM, EDGE mode to use this command.  
Use INSTRUMENT:SElect to set the mode.

---

**NOTE**

Option B7E: RF Comms Hardware has at least three possible part numbers. Press **System, More, Show Hdw** to show your instrument's RF Comms Hardware and view the part number. If the part number is E4401-60087 (the original version), the RF Burst trigger source will not be available with this measurement, and the default will be **EXTernal**.

---

### EDGE Error Vector Magnitude–Type of Test Condition

**[[:SENSe]:EEVM:TYPE:LIMit NORMAL|EXTreme**

**[[:SENSe]:EEVM:TYPE:LIMit?**

Name:	Type of Test Condition
Key Path:	<b>Meas Setup, Limit</b>
Factory Preset:	NORMal
State Saved:	Saved in instrument state.
Range:	NORMal, EXTreme
Example:	[[:SENSe]:EEVM:TYPE:LIMit NORMal



## EDGE Output RF Spectrum Measurement

Commands for querying the EDGE output RF spectrum measurement results and for setting to the default values are found in the “[MEASure Group of Commands](#)” on page 519. The equivalent front panel keys for the parameters described in the following commands, are found under the **Meas Setup** key, after the **EDGE Output RF Spectrum** measurement has been selected from the **MEASURE** key menu.

History: For E4406A: added in version A.04.00.  
For ESA: the EORF measurement was added in the GSM, EDGE personality version C.01.00.

### EDGE Output RF Spectrum—Number of Bursts Averaged

**[ :SENSe ] :EORFspectr:AVERAge:COUnT <integer>**

**[ :SENSe ] :EORFspectr:AVERAge:COUnT?**

Set the number of bursts that will be averaged. For the output RF spectrum due to switching transients, it is more accurate to consider this the number of frames that are measured. After the specified number of bursts (average counts), the averaging mode (termination control) setting determines the averaging action.

Factory Preset: 20 for VSA, PSA  
10 for ESA

Range: 1 to 10,000 for VSA, PSA  
1 to 1000 for ESA

Remarks: You must be in GSM, EDGE mode to use this command.  
Use INSTRument:SElect to set the mode.

### EDGE Output RF Spectrum—Fast Averaging

**[ :SENSe ] :EORFspectr:AVERAge:FAST [ :STATe ] OFF | ON | 0 | 1**

**[ :SENSe ] :EORFspectr:AVERAge:FAST [ :STATe ] ?**

Make the measurement faster by using an averaging technique different from that defined by the standard. A valid average can be obtained by measuring the power in half the normal number of bursts by using 50% - 90% of the burst, 10% - 50% of the burst and excluding the midamble.

This faster averaging is only done when averaging is on and only the modulation results are being measured. If both modulation and switching transients results are being measured, then the measurement uses the default averaging.

Factory Preset: ON

Remarks: You must be in GSM, EDGE mode to use this command.  
Use INSTRument:SElect to set the mode.

### EDGE Output RF Spectrum—Averaging Type for Modulation Spectrum

```
[ :SENSe ] :EORFspectr:AVERAge:MODulation:TYPE LOG | RMS
```

```
[ :SENSe ] :EORFspectr:AVERAge:MODulation:TYPE?
```

Select the type of averaging for measuring the modulation spectrum. This is an advanced control that normally does not need to be changed. Setting this to a value other than the factory default, may cause invalid measurement results.

LOG - The log of the power is averaged. (This is also known as video averaging.)

RMS - The power is averaged, providing the rms of the voltage.

Factory Preset: LOG

Remarks: You must be in GSM, EDGE mode to use this command.  
Use INSTRument:SElect to set the mode.

### EDGE Output RF Spectrum—Averaging Control

```
[ :SENSe ] :EORFspectr:AVERAge [ :STATE ] OFF | ON | 0 | 1
```

```
[ :SENSe ] :EORFspectr:AVERAge [ :STATE ] ?
```

Turn averaging on or off.

Factory Preset: ON for VSA, PSA  
OFF for ESA

Remarks: You must be in GSM, EDGE mode to use this command.  
Use INSTRument:SElect to set the mode.

### EDGE Output RF Spectrum—Resolution BW for the Modulation Spectrum at the Carrier

```
[ :SENSe ] :EORFspectr:BANDwidth | BWIDth [ :RESolution ]  
:MODulation:CARRier <freq>
```

```
[ :SENSe ] :EORFspectr:BANDwidth | BWIDth [ :RESolution ]  
:MODulation:CARRier?
```

Selects the resolution bandwidth for measuring the carrier when measuring spectrum due to modulation and wideband noise.

This parameter is only used with the Standard or Short lists, and not with the Custom list.

Factory Preset: 30 kHz

Range: 1 kHz to 5 MHz

Default Unit: Hz

Remarks: You must be in GSM, EDGE mode to use this command.  
Use INSTRUMENT:SElect to set the mode.

### EDGE Output RF Spectrum—Resolution BW For Modulation At Close Offsets

*For VSA, PSA:*

```
[ :SENSE ] :EORFspectr: BANDwidth | BWIDth [ :RESolution ]
:MODulation:OFFSet:CLOSE <freq>
```

```
[ :SENSE ] :EORFspectr: BANDwidth | BWIDth [ :RESolution ]
:MODulation:OFFSet:CLOSE?
```

*For ESA:*

```
[ :SENSE ] :EORFspectr: BANDwidth [ :RESolution ]
:MODulation:OFFSet:CLOSE <freq>
```

```
[ :SENSE ] :EORFspectr: BANDwidth [ :RESolution ]
:MODulation:OFFSet:CLOSE?
```

Set the resolution bandwidth used for the spectrum due to modulation part of the EORF measurement for offset frequencies less than 1800 kHz.

This parameter is only used with the Standard or Short lists, and not with the Custom list.

Factory Preset: 30 kHz

Range: 1 kHz to 5 MHz

Default Unit: Hz

Remarks: You must be in GSM, EDGE mode to use this command.  
Use INSTRUMENT:SElect to set the mode.

### EDGE Output RF Spectrum—Resolution BW for Modulation at Far Offsets

*For VSA, PSA:*

```
[ :SENSE ] :EORFspectr: BANDwidth | BWIDth [ :RESolution ]
:MODulation:OFFSet:FAR <freq>
```

```
[ :SENSe ] :EORFspectr:BAWdwidth|BWIDth[:RESolution]  
:MODulation:OFFSet:FAR?
```

*For ESA:*

```
[ :SENSe ] :EORFspectr:BAWdwidth[:RESolution]  
:MODulation:OFFSet:FAR <freq>
```

```
[ :SENSe ] :EORFspectr:BAWdwidth[:RESolution]  
:MODulation:OFFSet:FAR?
```

Set the resolution bandwidth used for the spectrum due to modulation part of the EORF measurement for offset frequencies greater than or equal to 1800 kHz.

This parameter is only used with the Standard or Short lists, and not with the Custom list.

Factory Preset: 100 kHz

Range: 1 kHz to 5 MHz

Default Unit: Hz

Remarks: You must be in GSM, EDGE mode to use this command.  
Use INSTRument:SElect to set the mode.

### EDGE Output RF Spectrum—Resolution BW for the Switching Transient Spectrum at the Carrier

```
[ :SENSe ] :EORFspectr:BAWdwidth|BWIDth[:RESolution]  
:SWITching:CARRier <freq>
```

```
[ :SENSe ] :EORFspectr:BAWdwidth|BWIDth[:RESolution]  
:SWITching:CARRier?
```

Selects the resolution bandwidth for the carrier when measuring spectrum due to switching transients.

This parameter is only used with the Standard or Short lists, and not with the Custom list.

Factory Preset: 300 kHz

Range: 1 kHz to 5 MHz

Default Unit: Hz

Remarks: You must be in GSM, EDGE mode to use this command.  
Use INSTRument:SElect to set the mode.

## EDGE Output RF Spectrum—Resolution BW For Switching Transients At Close Offsets

*For VSA, PSA:*

```
[ :SENSE ] :EORFspectr: BANDwidth | BWIDth [ :RESolution ]
:SWITching: OFFSet: CLOSe <freq>
```

```
[ :SENSE ] :EORFspectr: BANDwidth | BWIDth [ :RESolution ]
:SWITching: OFFSet: CLOSe?
```

*For ESA:*

```
[ :SENSE ] :EORFspectr: BANDwidth [ :RESolution ]
:SWITching: OFFSet: CLOSe <freq>
```

```
[ :SENSE ] :EORFspectr: BANDwidth [ :RESolution ]
:SWITching: OFFSet: CLOSe?
```

Set the resolution bandwidth used for the spectrum due to switching transients part of the EORF measurement for offset frequencies less than 1800 kHz.

This parameter is only used with the Standard or Short lists, and not with the Custom list.

Factory Preset: 30 kHz

Range: 1 kHz to 5 MHz

Default Unit: Hz

Remarks: You must be in GSM, EDGE mode to use this command.  
Use INSTRument:SElect to set the mode.

## EDGE Output RF Spectrum—Resolution BW For Switching Transients At Far Offsets

*For VSA, PSA:*

```
[ :SENSe ] :EORFspectr: BANDwidth | BWIDth [ :RESolution ]
:SWITching: OFFSet: FAR <freq>
```

```
[ :SENSE ] :EORFspectr: BANDwidth | BWIDth [ :RESolution ]
:SWITching: OFFSet: FAR?
```

*For ESA:*

```
[ :SENSE ] :EORFspectr: BANDwidth [ :RESolution ]
:SWITching: OFFSet: FAR <freq>
```

```
[ :SENSe ] :EORFspectr: BANDwidth [ :RESolution ]
:SWITching: OFFSet: FAR?
```

Set the resolution bandwidth used for the spectrum due to switching transients part of the EORF measurement for offset frequencies greater

than or equal to 1800 kHz.

This parameter is only used with the standard or short lists, and not with the custom list.

Factory Preset: 30 kHz

100 kHz

Range: 1 kHz to 5 MHz

Default Unit: Hz

Remarks: You must be in GSM, EDGE mode to use this command.  
Use INSTRument:SElect to set the mode.

### EDGE Output RF Spectrum—Break Frequency

**[ :SENSe ] :EORFSpectr:BFRequency <freq>**

**[ :SENSe ] :EORFSpectr:BFRequency?**

LP: keep the ORFS meas tracking with this command.

Set the direct time break frequency. An FFT measurement method is used for offsets below this break frequency. The direct time measurement method is used for offsets above the break frequency. See the Making EDGE (with GSM) Measurement chapter for more information about these two methods.

Factory Preset: 600 kHz

Range: 0 kHz to 775 kHz

Default Unit: Hz

Remarks: You must be in GSM, EDGE mode to use this command.  
Use INSTRument:SElect to set the mode.

Front Panel

Access: **Meas Setup, Advanced, Direct Time Break Freq**

### EDGE Output RF Spectrum—Peak Detection mode

**[ :SENSe ] :EORFSpectrum:DETEctor:SWITching:FAST [ :STATe ]  
OFF | ON | 0 | 1**

**[ :SENSe ] :EORFSpectrum:DETEctor:SWITching?**

Sets the detection mode to “fast peak”. This setting functions when “measurement type” selected is Switching or Switching & Modulation.

Factory Preset: On

Remarks: You must be in the GSM or EDGE mode to use this

command. Use INSTRument:SElect to set the mode.

Front Panel

Access: **Meas Setup, More (1 of 2), Advanced**

State Saved: Saved in Instrument State

### EDGE ORFS - Meas Method

**[ :SENSE ] :EORFspectr:MEASure MULTiple | SINGLE | SWEPT**

**[ :SENSE ] :EORFspectr:MEASure?**

Name:	Meas Method
Key Path:	<b>Meas Setup</b>
Factory Preset:	MULTiple ,
State Saved:	Saved in instrument state.
Range:	Multi-Offset   Single Offset (Examine)   Swept ,
Dependencies and Couplings:	Swept choice is available only if Meas Type is Modulation. Otherwise, the Swept choice is grayed out.  If Swept is selected and Meas Type is not Modulation, the measurement algorithm internally assumes that Meas Method is Multi-Offset.
Example:	:SENSE:EORFspectr:MEASure MULTiple

### EDGE ORFS - Custom Modulation Apply Limit Level Offsets

**[ :SENSE ] :EORFspectr:LIST:MODulation:APPLY  
RELative | BOTH | ABSolute { , RELative | BOTH | ABSolute }**

**[ :SENSE ] :EORFspectr:LIST:MODulation:APPLY?**

Name:	Custom Modulation Apply Limit Level Offsets
Key Path:	<b>Meas Setup, 5</b>
Default:	BOTH, BOTH, BOTH, BOTH, BOTH, BOTH, BOTH, BOTH, BOTH, BOTH, BOTH, BOTH, BOTH, BOTH, BOTH
State Saved:	Saved in instrument state.
Range:	Rel   Both   Abs

Example: :SENSe:EORFspectr:LIST:MODulation:APPLy  
RELative, RELative, RELative

Array Length: Any number from 1 to 15 is acceptable as long as  
the following arrays have the same number of  
elements:

- Custom Switching Offset Frequency
- Custom Switching Resolution Band Width
- Custom Switching Relative Limit Level Offsets
- Custom Switching Absolute Limit Level Offsets
- Custom Switching Apply Limit Level Offsets

### EDGE Output RF Spectrum—Define Custom Modulation Resolution Bandwidth List

```
[ :SENSe ] :EORFspectr:LIST:MODulation:BANDwidth | BWIDth  
<res bw> { , <res bw> }
```

```
[ :SENSe ] :EORFspectr:LIST:MODulation:BANDwidth | BWIDth ?
```

Define the custom set of resolution bandwidths for the modulation spectrum part of the EORF measurement. The first bandwidth specified is for the carrier. Each resolution bandwidth in this list corresponds to an offset frequency in the modulation offset frequency list. The number of items in each of these lists needs to be the same.

Factory Preset: Same as standard list

Range: 1 kHz to 5 MHz

Default Unit: Hz

Remarks: This command is only valid if SENS:EORF:MEAS is set to multiple and the custom list type is selected with SENS:EORF:LIST:SEL CUST.

You must be in GSM, EDGE mode to use this command.  
Use INSTRument:SElect to set the mode.

### EDGE ORFS - Custom Modulation State

```
[ :SENSe ] :EORFspectr:LIST:MODulation[:FREQuency] <offset  
freq> { , <offset freq> }
```

```
[ :SENSe ] :EORFspectr:LIST:MODulation[:FREQuency] ?
```

```
[ :SENSe ] :EORFspectr:LIST:MODulation:STATE  
OFF | ON | 0 | 1 { , OFF | ON | 0 | 1 }
```



**[ :SENSE ] :EORFspectr:LIST:MODulation:STATE?**

Name:	Custom Modulation Offset Freq
Key Path:	<b>Meas Setup, 5</b>
Active Function Text:	Offset Freq
Default Terminator:	Hz   kHz   MHz   GHz
Factory Presets	
Frequency:	0.0, 1.0e5, 2.0e5, 2.5e5, 4.0e5, 6.0e5, 8.0e5, 1.0e6, 1.2e6, 1.4e6, 1.6e6, 1.8e6, 3.0e6, 6.0e6
State:	1, 1, 1, 1, 1, 1, 1, 1, 1, 1, 1, 1, 1, 1
State Saved:	Saved in instrument state.
SCPI Resolution:	1.0 Hz
Example:	:SENSE:EORFspectr:LIST:MODulation:FREQuency 0.0, 1.0e5, 2.0e5  :SENSE:EORFspectr:LIST:MODulation:STATE ON, ON, ON
Array Length:	Any number from 1 to 15 is acceptable as long as the following arrays have the same number of elements:  Custom Switching Offset Frequency Custom Switching Resolution Band Width Custom Switching Relative Limit Level Offsets Custom Switching Absolute Limit Level Offsets Custom Switching Apply Limit Level Offsets

**EDGE ORFS - Custom Modulation Absolute Limit Level Offsets**

**[ :SENSE ] :EORFspectr:LIST:MODulation:LOFFset:ABSolute <level>{, <level>}**

**[ :SENSE ] :EORFspectr:LIST:MODulation:LOFFset:ABSolute?**

Name:	Custom Modulation Absolute Limit Level Offsets
Key Path:	<b>Meas Setup, 5</b>
Unit:	dB

Default:	0.0
State Saved:	Saved in instrument state.
Resolution:	0.1 dB
Example:	:SENSe:EORFspectr:LIST:MODulation:LOFFset: ABSolute 0.0, -2.0, -5.0
Array Length:	Any number from 1 to 15 is acceptable as long as the following arrays have the same number of elements:
	Custom Switching Offset Frequency
	Custom Switching Resolution Band Width
	Custom Switching Relative Limit Level Offsets
	Custom Switching Absolute Limit Level Offsets
	Custom Switching Apply Limit Level Offsets

### EDGE Output RF Spectrum—Define Custom Modulation Relative Limit Level Offsets

```
[ :SENSe ] :EORFspectr:LIST:MODulation:LOFFset
[ :RCARrier ] <level> { , <level> }
```

```
[ :SENSe ] :EORFspectr:LIST:MODulation:LOFFset [ :RCARrier ] ?
```

Define the custom set of level offsets for the modulation spectrum part of the EORF measurement. This allows you to modify the standard limits by adding a delta amplitude value to them. The first level offset specified must be 0 dB for the carrier. Each level offset in this list corresponds to an offset frequency in the modulation offset frequency list. The number of items in each of these lists needs to be the same.

**Example:**      `EORF:LIST:MOD:FREQ 0,300e3,1.3e6,2.0e6`  
                   Sets custom offset freqs: 300 kHz, 1.3 MHz, 2 MHz

`EORF:LIST:MOD:BAND 30e3,30e3,30e3,100e3`  
                   Sets corresponding RBWs: 30 kHz, 30 kHz, 100 kHz

`EORF:LIST:MOD:LOFFset 0,-5,3,5`  
                   Assume the power level of the signal is -43 dBm, then the standard limits for these three offsets are: -42 dBc, -72 dBc, -75 dBc respectively. The LOFFset command adjusts these limits to: -47 (-42-5) dBc, -70 (-73+3) dBc, -70 (-75+5) dBc.

**Factory Preset:** 0 dB level offsets (limits remain the same as the standards)

Range: 0 to 50 dB  
 Default Unit: dB  
 Remarks: This command is only valid if SENS:EORF:MEAS is set to multiple and the custom list type is selected with SENS:EORF:LIST:SEL CUST.  
 You must be in GSM, EDGE mode to use this command. Use INSTRument:SElect to set the mode.

### EDGE Output RF Spectrum—Offset Frequency List

*For VSA, PSA:*

**[ :SENSe ] :EORFspectr:LIST:SElect CUSTom | SHORt | STANdard**

**[ :SENSe ] :EORFspectr:LIST:SElect?**

*For ESA:*

**[ :SENSe ] :EORFspectr:LIST:SElect SHORt | STANdard**

**[ :SENSe ] :EORFspectr:LIST:SElect?**

Select the list of settings that will be used to make the EORF measurement. This specifies standard or customized lists and short lists. The lists contain the offset frequencies (and bandwidths) that are used for the modulation spectrum and transient spectrum parts of the EORF measurement.

CUSTom - uses the four user-defined lists that specify:

- Offset frequencies for modulation spectrum measurement
- Corresponding resolution bandwidths for each of the modulation offset frequencies
- Offset frequencies for switching transient spectrum measurement
- Corresponding resolution bandwidths for each of the switching transient offset frequencies

SHORt - a shortened list of the offset frequencies specified in the EDGE Standards. It uses two internal offset frequency lists, one for modulation spectrum and the other for switching transient spectrum. These offset frequencies cannot be changed, but the resolution bandwidths can be changed by other commands in the SENSe:EORFpectr subsystem.

STANdard - the complete list of the offset frequencies specified in the EDGE Standards, except for those offsets greater than 6 MHz. It uses two internal offset frequency lists, one for modulation spectrum and the other for switching transient spectrum. These offset frequencies cannot be changed, but the resolution bandwidths can be changed by other commands in the SENSe:EORFpectr subsystem.

Factory Preset: SHORT

Remarks: This command is only valid if SENS:EORF:MEAS is set to multiple.

If you change the number of custom offsets then the number of offset bandwidths, frequencies and level offsets must also be changed.

You must be in GSM, EDGE mode to use this command. Use INSTRUMENT:SElect to set the mode.

### EDGE ORFS - Custom Switching Apply Limit Level Offsets

```
[ :SENSe ] :EORFspectr:LIST:SWITching:APPLy  
RELative | BOTH | ABSolute { , RELative | BOTH | ABSolute }
```

```
[ :SENSe ] :EORFspectr:LIST:SWITching:APPLy?
```

Name:	Custom Switching Apply Limit Level Offsets
Key Path:	<b>Meas Setup, 5</b>
Default:	BOTH, BOTH, BOTH, BOTH, BOTH, BOTH, BOTH, BOTH, BOTH, BOTH, BOTH, BOTH, BOTH, BOTH, BOTH
State Saved:	Saved in instrument state.
Range:	Rel   Both   Abs
Example:	:SENSe:EORFspectr:LIST:SWITching:APPLy RELative, RELative, RELative
Array Length:	Any number from 1 to 15 is acceptable as long as the following arrays have the same number of elements:  Custom Switching Offset Frequency Custom Switching Resolution Band Width Custom Switching Relative Limit Level Offsets Custom Switching Absolute Limit Level Offsets Custom Switching Apply Limit Level Offsets

### EDGE ORFS - Custom Switching Absolute Limit Level Offsets

```
[ :SENSe ] :EORFspectr:LIST:SWITching:LOFFset:ABSolute  
<level> { , <level> }
```

**[ :SENSe ] :EORFspectr:LIST:SWITching:LOFFset:ABSolute?**

Name:	Custom Switching Absolute Limit Level Offsets
Key Path:	<b>Meas Setup, 5</b>
Unit:	DB
Default:	0.0
State Saved:	Saved in instrument state.
Resolution:	0.1 dB
Example:	:SENSe:EORFspectr:LIST:SWITching:LOFFset:ABSolute 0.0, -2.0, -5.0
Array Length:	Any number from 1 to 15 is acceptable as long as the following arrays have the same number of elements:  Custom Switching Offset Frequency Custom Switching Resolution Band Width Custom Switching Relative Limit Level Offsets Custom Switching Absolute Limit Level Offsets Custom Switching Apply Limit Level Offsets

**EDGE ORFS - Custom Switching State**

**[ :SENSe ] :EORFspectr:LIST:SWITching[:FREQUENCY] <offset freq>{,<offset freq>}**

**[ :SENSe ] :EORFspectr:LIST:SWITching[:FREQUENCY] ?**

**[ :SENSe ] :EORFspectr:LIST:SWITching:STATE OFF | ON | 0 | 1 { , OFF | ON | 0 | 1 }**

**[ :SENSe ] :EORFspectr:LIST:SWITching:STATE?**

Name:	Custom Switching Offset Freq
Key Path:	<b>Meas Setup, 5</b>
Active Function Text:	Offset Freq
Default Terminator:	Hz   kHz   MHz   GHz

Factory Presets:	
Frequency:	0.0, 4.0e5, 6.0e5, 1.2e6, 1.8e6
State:	1, 1, 1, 1, 1
State Saved:	Saved in instrument state.
SCPI Resolution:	1.0 Hz
Example:	:SENSe:EORFspectr:LIST:SWITching:FREQue ncy 0.0, 1.0e5, 2.0e5  :SENSe:EORFspectr:LIST:SWITching:STATE ON, ON, ON
Array Length:	Any number from 1 to 15 is acceptable as long as the following arrays have the same number of elements:  Custom Switching Offset Frequency Custom Switching Resolution Band Width Custom Switching Relative Limit Level Offsets Custom Switching Absolute Limit Level Offsets Custom Switching Apply Limit Level Offsets

### EDGE Output RF Spectrum—Define Custom Switching Transient Resolution Bandwidth List

**[[:SENSe]:EORFspectr:LIST:SWITching:BANDwidth|BWIDth <res  
bw>{, <res bw>}**

**[[:SENSe]:EORFspectr:LIST:SWITching:BANDwidth|BWIDth?**

Define the custom set of resolution bandwidths for the switching transient spectrum part of the EORF measurement. The first bandwidth specified is for the carrier. Each resolution bandwidth in this list corresponds to an offset frequency in the switching transient offset frequency list. The number of items in each of these lists needs to be the same.

Factory Preset: Same as standard list

Range: 1 kHz to 5 MHz

Default Unit: Hz

Remarks: This command is only valid if SENS:EORF:MEAS is set to multiple and the custom list type is selected with SENS:EORF:LIST:SEL CUST.

You must be in EDGE(w/GSM) mode to use this command. Use INSTRument:SElect to set the mode.

## EDGE Output RF Spectrum—Define Custom Switching Transient Offset Frequency List

```
[ :SENSE ] :EORFspectr:LIST:SWITChing [ :FREQuency ]
<offset freq> { , <offset freq> }
```

```
[ :SENSE ] :EORFspectr:LIST:SWITChing [ :FREQuency ] ?
```

Define the custom set of offset frequencies at which the switching transient spectrum part of the EORF measurement will be made. The first offset specified must be 0 Hz, for the carrier. For each offset frequency specified, the power will be measured at both the lower and upper offsets. Up to 14 (+ the 0 Hz carrier frequency) offset frequencies may be defined.

Factory Preset: Same as standard list

Range: 10 kHz to 10 MHz

Default Unit: Hz

Remarks: This command is only valid if SENS:EORF:MEAS is set to multiple and the custom list type is selected with SENS:EORF:LIST:SEL CUST.

You must be in GSM, EDGE mode to use this command.  
Use INSTRument:SELEct to set the mode.

## EDGE Output RF Spectrum—Define Custom Switching Transient Relative Limit Level Offsets

```
[ :SENSE ] :EORFspectr:LIST:SWITChing:LOFFset [ :RCARrier ]
<level> { , <level> }
```

```
[ :SENSE ] :EORFspectr:LIST:SWITChing:LOFFset [ :RCARrier ] ?
```

Define the custom set of level offsets for the switching transient spectrum part of the EORF measurement. This allows you to modify the standard limits by adding a delta amplitude value to them. The first level offset specified must be 0 dB for the carrier. Each level offset in this list corresponds to an offset frequency in the modulation offset frequency list. The number of items in each of these lists needs to be the same.

Example: See the EORF:LIST:MOD:LOFF example above.

Factory Preset: 0 dB level offsets (limits remain the same as the standards)

Range: 0 to 50 dB

Default Unit: dB

Remarks: This command is only valid if SENS:EORF:MEAS is set to multiple and the custom list type is selected with

SENS:EORF:LIST:SEL CUST.

You must be in EDGE(w/GSM) mode to use this command. Use INSTRUMENT:SElect to set the mode.

### EDGE Output RF Spectrum—Measure Offsets Measurement Method

*For VSA, PSA, ESA:*

**[[:SENSe]:EORFspectr:MEASure MULTiple|SINGLE|SWEpt**

**[[:SENSe]:EORFspectr:MEASure?**

Select the measurement method to be used.

**MULTiple** - the measurement is done at all offsets in the offset frequency list.

**SINGLE** - the measurement is done at only one offset as determined by the offset frequency setting. This allows detailed examination of the time-domain waveform at the specified offset frequency.

**SWEpt** - sets the trigger source to free run. The previous trigger source selection is restored when measurement mode is returned to **SINGLE** or **MULTiple**.

Factory Preset: **MULTiple**

Remarks: You must be in GSM, EDGE mode to use this command. Use INSTRUMENT:SElect to set the mode.

### EDGE Output RF Spectrum—Offset Frequency

**[[:SENSe]:EORFspectr:OFRequency <freq>**

**[[:SENSe]:EORFspectr:OFRequency?**

Set the offset frequency that is used to measure a single offset. This command is only valid if SENS:EORF:MEAS is set to single.

Factory Preset: 250 kHz

Range: -12.0 MHz to +12.0 MHz for VSA, PSA  
-6.0 MHz to +6.0 MHz for ESA

Step Size: Steps through the values in the selected offset frequency list

Default Unit: Hz

Remarks: You must be in GSM, EDGE mode to use this command. Use INSTRUMENT:SElect to set the mode.



## EDGE Output RF Spectrum—Trigger Source

For VSA, PSA:

```
[ :SENSE ] :EORFspectr:TRIGger:SOURce
EXTErnal [1] | EXTErnal2 | FRAMe | IMMEDIATE
| RFBURSt
```

```
[ :SENSE ] :EORFspectr:TRIGger:SOURce?
```

For ESA:

```
[ :SENSE ] :EORFspectr:TRIGger:SOURce EXTErnal | FRAMe | RFBURSt
```

```
[ :SENSE ] :EORFspectr:TRIGger:SOURce?
```

Select the trigger source used to control the data acquisitions.

EXTErnal 1 - front panel external trigger input

EXTErnal 2 - rear panel external trigger input

EXTErnal - rear panel external trigger input for ESA, front panel external trigger input for VSA, PSA

FRAMe - uses the internal frame timer, which has been synchronized to the selected burst sync

IMMEDIATE - the next data acquisition is immediately taken, capturing the signal asynchronously (also called free run)

RFBURSt - wideband RF burst envelope trigger that has automatic level control for periodic burst signals

Factory Preset: RFBURSt for VSA, PSA

RFBURSt for ESA with options B7E/B7D

EXTErnal for ESA without options B7E/B7D

Remarks: You must be in GSM, EDGE mode to use this command. Use INSTRUMENT:SELEct to set the mode.

---

### NOTE

Option B7E: RF Comms Hardware has at least three possible part numbers. Press **System, More, Show Hdwr** to show your instrument's RF Comms Hardware and view the part number. If the part number is E4401-60087 (the original version), the RF Burst trigger source will not be available with this measurement, and the default will be **EXTErnal**.

---

## EDGE Output RF Spectrum—Measurement Type

For VSA, PSA:

```
[ :SENSE ] :EORFspectr:TYPE
```

**MODulation | MSWitching | SWITching | FFModulation**

**[ :SENSe ] :EORFspectr:TYPE?**

*For ESA:*

**[ :SENSe ] :EORFspectr:TYPE MODulation | SWITching**

**[ :SENSe ] :EORFspectr:TYPE?**

Select the measurement type.

MODulation - only the modulation spectrum is measured.

MSWitching (Modulation & Switching - VSA, PSA only)- both modulation and switching transient spectrums are measured.

SWITching - only the switching transient spectrum is measured.

FFModulation (VSA, PSA only) - full frame modulation improves measurement speed by acquiring a full frame of data prior to performing the FFT calculation. FFT modulation can only be used if all slots in the transmitted frame are active.

Factory Preset: MODulation

Remarks: You must be in the GSM, EDGE mode to use this command. Use INSTRument:SElect to set the mode.

### EDGE Output RF Spectrum—Select Modulation Method

**[ :SENSe ] :EORFspectr:TYPE:MODulation[:METHod] DIScrete | SWEEp**

**[ :SENSe ] :EORFspectr:TYPE:MODulation[:METHod] ?**

Selects discrete or sweep modulation method.

Discrete - Measures RF output spectrum at preset frequency offsets. Results are returned in tabular form.

Sweep - Measures output RF spectrum from -1.8 MHz to +1.8 MHz offset in approximately 10 kHz steps. Results are returned as a trace.

Remarks: You must be in GSM, EDGE, GSM mode to use this command. Use INSTRument:SElect to set the mode.

## EDGE Power vs. Time (Burst Power) Measurement

Commands for querying the power versus time measurement results and for setting to the default values are found in the “MEASure Group of Commands” on page 519. The equivalent front panel keys for the parameters described in the following commands, are found under the **Meas Setup** key, after the **EDGE PvT** measurement has been selected from the **MEASURE** key menu.

History: For E4406A: added in version A.04.00.  
For ESA: the EPVT measurement was added in the GSM, EDGE personality version C.01.00.

### EDGE Power vs. Time—Number of Bursts Averaged

**[ :SENSe ] :EPVTime :AVERAge :COUNT <integer>**

**[ :SENSe ] :EPVTime :AVERAge :COUNT ?**

Set the number of bursts that will be averaged. After the specified number of bursts (average counts), the averaging mode (termination control) setting determines the averaging action.

Factory Preset: 10

Range: 1 to 10,000 for PSA, VSA  
1 to 1000 for ESA

Remarks: You must be in the GSM, EDGE mode to use this command. Use INSTRument:SElect to set the mode.

### EDGE Power vs. Time—Averaging State

**[ :SENSe ] :EPVTime :AVERAge [ :STATe ] OFF | ON | 0 | 1**

**[ :SENSe ] :EPVTime :AVERAge [ :STATe ] ?**

Turn averaging on or off.

Factory Preset: OFF

Remarks: You must be in the GSM, EDGE mode to use this command. Use INSTRument:SElect to set the mode.

### EDGE Power vs. Time—Averaging Termination Control

**[ :SENSe ] :EPVTime :AVERAge :TCONtrol EXPONential | REPeat**

**[ :SENSe ] :EPVTime :AVERAge :TCONtrol ?**

Select the type of termination control used for the averaging function.

This specifies the averaging action after the specified number of bursts (average count) is reached.

EXponential - After the average count has been reached, each successive data acquisition is exponentially weighted and combined with the existing average.

REPeat - After reaching the average count, the averaging is reset and a new average is started.

Factory Preset: EXPonential

Remarks: You must be in the GSM, EDGE mode to use this command. Use INSTRument:SElect to set the mode.

### EDGE Power vs. Time—Averaging Type

*For VSA, PSA:*

```
[ :SENSe ] :EPVTime:AVERage:TYPE  
LOG | MAXimum | MINimum | MXMinimum | RMS
```

```
[ :SENSe ] :EPVTime:AVERage:TYPE?
```

*For ESA:*

```
[ :SENSe ] :EPVTime:AVERage:TYPE LPOWer | POWer
```

```
[ :SENSe ] :EPVTime:AVERage:TYPE?
```

Select the type of averaging to be performed.

LOG - The log of the power is averaged. (This is also known as video averaging.)

MAXimum - The maximum values are retained.

MINimum - The minimum values are retained.

MXMinimum - Both the maximum and the minimum values are retained.

RMS - The power is averaged, providing the rms of the voltage.

LPOWer - Sums the trace data and divides by the average count.

POWer - Trace data is converted from dB to power units, then averaged. This type is more time consuming.

Factory Preset: RMS for VSA, PSA

POWer for ESA

Remarks: You must be in the GSM, EDGE mode to use this command. Use INSTRument:SElect to set the mode.

### EDGE Power vs. Time—Resolution BW

```
[ :SENSe ] :EPVTime :BANDwidth | BWIDth [ :RESolution ] <freq>
[ :SENSe ] :EPVTime :BANDwidth | BWIDth [ :RESolution ] ?
```

Set the resolution BW. This is an advanced control that normally does not need to be changed. Setting this to a value other than the factory default, may cause invalid measurement results.

Factory Preset: 500 kHz for VSA, PSA  
300 kHz for ESA

Range: 1 kHz to 5 MHz for VSA, PSA  
1 kHz to 5 MHz for ESA without Option 1DR  
10 Hz to 5 MHz for ESA with Option 1DR  
1 Hz to 5 MHz for ESA with Options 1DR and 1D5

Default Unit: Hz

Remarks: You must be in the GSM, EDGE mode to use this command. Use INSTRument:SElect to set the mode.

### EDGE Power vs. Time—RBW Filter Type

```
[ :SENSe ] :EPVTime :BANDwidth | BWIDth [ :RESolution ] :TYPE
FLATtop | GAUSSian
```

```
[ :SENSe ] :EPVTime :BANDwidth | BWIDth [ :RESolution ] :TYPE?
```

Select the type of resolution BW filter. This is an advanced control that normally does not need to be changed. Setting this to a value other than the factory default, may cause invalid measurement results.

FLATtop - a filter with a flat amplitude response, which provides the best amplitude accuracy.

GAUSSian - a filter with Gaussian characteristics, which provides the best pulse response.

Factory Preset: GAUSSian

Remarks: You must be in the GSM, EDGE mode to use this command. Use INSTRument:SElect to set the mode.

### EDGE PvT Timeslot Length

```
[ :SENSe ] :EPVTime :BSYNc :SLEngth EVEN | INTeger
[ :SENSe ] :EPVTime :BSYNc :SLEngth?
```

Name:	EDGE P <sub>v</sub> T Timeslot Length
Key Path:	<b>Meas Setup, More, Advanced</b>
Factory Preset:	INTeger
State Saved:	Saved in instrument state.
Range:	All 156.25 symb   157/156 symb
Dependencies and Couplings:	This parameter is available only if the Burst Sync type is None.
Example:	:SENSe:PVTTime:BSYNc:SLENGth INTeger

### EDGE P<sub>v</sub>T Burst Synchronization Source

[ :SENSe ] :EPVTime:BSYNc:SOURce TSEQuence | RFBurst | NONE

[ :SENSe ] :EPVTime:BSYNc:SOURce?

This parameter specifies how the measurement algorithm synchronizes the reference time with the given signal. Castagna adds the 3rd choice.

KEY Training Seq SCPI TSEQuence	The measurement algorithm first searches bursts and then searches training sequence (midamble) of each burst to determine the reference time for the limit mask. The reference time is adjusted slot-by-slot.
KEY RF Amptd SCPI RFBurst	The measurement algorithm calculates the burst width and determines the reference time for the limit mask so that the t <sub>0</sub> comes to the center of each burst. The reference time is adjusted slot-by-slot.
KEY None (Trigger Delay) SCPI NONE	The measurement algorithm does not search bursts at all. The timing to capture data is determined by user-defined Trigger Delay.

Name:	EDGE P <sub>v</sub> T Burst Synchronization Source
Key Path:	<b>Meas Setup</b>
Factory Preset:	TSEQuence
State Saved:	Saved in instrument state.

Range:	Training Seq   RF Amptd   None (Trigger Delay)
Notes:	None choice is always available. However, the choice is meaningful only if the Trig Source is Ext Front or Ext Rear.
Example:	:SENSe:EPVTime:BSYNc:SOURce TSEQUence

### EDGE Power vs. Time—Limit Line Mask Display

**[ :SENSe ] :EPVTime:LIMit:MASK OFF | ON | 0 | 1**

**[ :SENSe ] :EPVTime:LIMit:MASK?**

Show or hide the limit mask. Does not affect limit pass/fail calculation.

Same as :DISPlay:EPVTime:LIMit:MASK. The sense version was added to be compatible/consistent with ESA.

Factory Preset: ON

Range: ON | OFF

Remarks: You must be in GSM, EDGE mode to use this command. Use INSTRument:SElect to set the mode.

### EDGE Power vs. Time—Lower Mask Absolute Amplitude Levels

**[ :SENSe ] :EPVTime:MASK:LIST:LOWer:ABSolute  
<power>, <power>, <power>, <power>, <power>, . . .**

**[ :SENSe ] :EPVTime:MASK:LIST:LOWer:ABSolute?**

Enter a power level for any of your mask line segments that require an absolute minimum power limit in addition to its relative limit. Each time a measurement is made the Ref Level is determined. (This is the power level of the useful part of the burst, or midway between the upper/lower masks). Remember, as the power of the Ref Level changes, all of the relative mask power levels will change by the same amount.

Each relative limit is then compared to the Ref Level and an equivalent absolute power level is calculated. This power level is compared to the specified absolute limit for each line segment. If this calculated relative limit is lower than the absolute limit you've specified, then the value of the absolute limit is used for this segment. Therefore, if the absolute limit is set to a very low value (–200 dBm), the calculated value of the reference limit will never be lower, and the specified relative limit will always be used for that segment. See [Figure 1 on page 411](#).

Every time point you defined with PVT:MASK:LOW:TIME must have a power value defined in the same order. You can put a comma in the SCPI command as a place holder for any points where an absolute power is not specified, and that segment will then use the default value.

Factory Preset: Selected EDGE standard

Range: -200 dBm to +100 dBm

Default Unit: dBm

Remarks: You must be in GSM, EDGE mode to use this command.  
Use INSTRument:SElect to set the mode.

### EDGE Power vs. Time—Lower Mask Points

**[ :SENSe ] :EPVTime:MASK:LIST:LOWer:POINTs?**

Query the number of elements in the lower mask. This value is determined by the number of time points entered using  
[ :SENSe ] :EPVTime:MASK:LIST:LOWer:TIME.

Range: integer, 1 to 25

Remarks: You must be in GSM, EDGE mode to use this command.  
Use INSTRument:SElect to set the mode.

### EDGE Power vs. Time—Lower Mask Relative Amplitude Levels

**[ :SENSe ] :EPVTime:MASK:LIST:LOWer:RELative**  
**<rel\_power>, <rel\_power>, <rel\_power>, <rel\_power>, <rel\_power>**  
**, ...**

**[ :SENSe ] :EPVTime:MASK:LIST:LOWer:RELative?**

Enter the relative power level for each horizontal line segment in the lower limit mask. There should be a power level for each time point entered using [ :SENSe ] :EPVTime:MASK:LIST:LOWer:TIME, and they must be entered in the same order. These power levels are all relative to the defined Reference Power Level (the average power in the useful part of the data).

Any portion of the signal that has no limit line segment defined for it, will default to a very low limit (-100 dB relative to the reference power). This will keep the measurement from indicating a failure for that portion of the data.

Factory Preset: Selected EDGE standard

Range: +200 dB to -100 dB, relative to the reference power

Default Unit: dB

Remarks: You must be in GSM, EDGE mode to use this command.  
Use INSTRument:SElect to set the mode.



## EDGE Power vs. Time—Lower Mask Time Points

```
[ :SENSe ] :EPVTime:MASK:LIST:LOWer:TIME
<seconds>, <seconds>, <seconds>, <seconds>, <seconds>, ...
```

```
[ :SENSe ] :EPVTime:MASK:LIST:LOWer:TIME?
```

Enter the time points that define the horizontal line segments of the lower limit. A reference point designated “ $t_0$ ” is at the center of the useful data (usually the center of the burst). Each line segment to the right of the  $t_0$  reference point is designated as a positive time value and each segment to the left of  $t_0$  is a negative time value.

First enter positive values in sequence starting from  $t_0$ , then negative values in sequence starting from  $t_0$ . See [Figure 1 on page 411](#) and the [ :SENSe ] :EPVT:MASK:LIST:UPPER:TIME example below it. (This is an upper mask example, but they work the same.)

We recommend that you select a large time value for your first and last mask points (e.g. -1 and +1 second). This guarantees that you’ve defined a limit for all the measured data. (See Mask Segments 4 and 9 in the [Table on page 411](#) for an example.)

Factory Preset: Selected EDGE standard

Range: -1s to +1s, referenced to  $t_0$  at the center of the useful data (burst center)

1 to 25 time points in a mask

Default Unit: seconds

Remarks: You must be in the GSM, EDGE mode to use this command. Use INSTRument:SElect to set the mode.

## EDGE Power vs. Time—Upper Mask Absolute Amplitude Levels

```
[ :SENSe ] :EPVTime:MASK:LIST:UPPer:ABSolute
<power>, <power>, <power>, <power>, <power>, ...
```

```
[ :SENSe ] :EPVTime:MASK:LIST:UPPer:ABSolute?
```

Enter a power level for any of your mask line segments that require an absolute minimum power limit in addition to its relative limit. Each time a measurement is made the Ref Level is determined. (This is the power level of the useful part of the burst, or midway between the upper/lower masks). Remember, as the power of the Ref Level changes, all of the relative mask power levels will change by the same amount.

Each relative limit is then compared to the Ref Level and an equivalent absolute power level is calculated. This power level is compared to the specified absolute limit for each line segment. If this calculated relative limit is lower than the absolute limit you’ve specified, then the value of

the absolute limit is used for this segment. Therefore, if the absolute limit is set to a very low value (–200 dBm), the calculated value of the reference limit will never be lower, and the specified relative limit will always be used for that segment. See [Figure 1 on page 411](#).

Every time point you defined with PVT:MASK:LOW:TIME must have a power value defined in the same order. You can put a comma in the SCPI command as a place holder for any points where an absolute power is not specified, and that segment will then use the default value.

Example: **EPVT:MASK:LIST:UPP:ABS**  
**-200,-200,-58,-200,-200,-200,-200,-58,-200**

Factory Preset: Selected EDGE standard

Range: –200 dBm to +100 dBm

Default Unit: dBm

Remarks: You must be in GSM, EDGE mode to use this command.  
Use INSTRument:SElect to set the mode.

### EDGE Power vs. Time—Upper Mask Points

**[ :SENSe ] :EPVTime:MASK:LIST:UPPer:POINTs?**

Query the number of elements in the upper mask. This value is determined by the number of time points entered using

**[ :SENSe ] :EPVTime:MASK:LIST:UPPer:TIME.**

Range: integer, 1 to 25

Remarks: You must be in GSM, EDGE mode to use this command.  
Use INSTRument:SElect to set the mode.

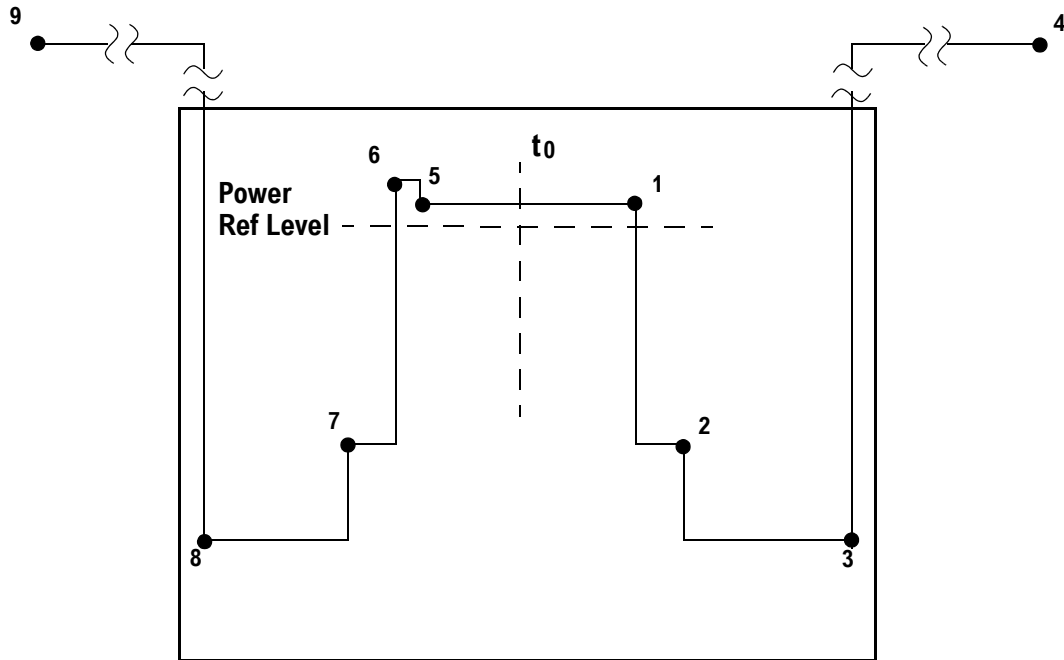
### EDGE Power vs. Time—Upper Mask Relative Amplitude Levels

**[ :SENSe ] :EPVTime:MASK:LIST:UPPer:RELative**  
**<rel\_power>,<rel\_power>,<rel\_power>,<rel\_power>,<rel\_power>**  
**,...**

**[ :SENSe ] :EPVTime:MASK:LIST:UPPer:RELative?**

Enter the relative power level for each horizontal line segment in the upper limit mask. There should be a power level for each time point entered using **[ :SENSe ] :EPVTime:MASK:LIST:UPPer:TIME**, and they must be entered in the same order. These power levels are all relative to the defined Reference Power Level (the average power in the useful part of the data). See [Figure 1 on page 411](#).

Figure 1 Custom Upper Limit Mask Example



Entered Value for each Time Segment	Absolute Time Value	Relative Power (example (with Ref Level = -12 dBm))		Entered Absolute Power (dBm)	Segment Number
		Entered Relative Power	Equivalent Absolute Power		
280.0e-6	280 $\mu$ s	+4 dBc	-8 dBm	-200 dBm	1
15.0e-6	295 $\mu$ s	-32 dBc	-44 dBm	-200 dBm	2
450.0e-6	745 $\mu$ s	-48 dBc	-60 dBm <sup>a</sup>	-58 dBm <sup>a</sup>	3
1	>1 sec	+100 dBc	+88 dBm	-200 dBm	4
-270.0e-6	-270 $\mu$ s	+4 dBc	-8 dBm	-200 dBm	5
-10.0e-6	-280 $\mu$ s	+7 dBc	-5 dBm	-200 dBm	6
-20.0e-6	-300 $\mu$ s	-25 dBc	-37 dBm	-200 dBm	7
-450e-6	-750 $\mu$ s	-43 dBc	-55 dBm	-58 dBm	8
-1	<-1 sec	+100 dBc	+88 dBm	-200 dBm	9

a. Notice that this segment, with this value of Ref Level, has a calculated relative level of -60 dBm. This is lower than the specified absolute level of -58 dBm, so the -58 dBm value will be used as the test limit for the segment.

Example: `EPVT:MASK:LIST:UPP:REL 4, -32, -48, 100, 4, 7,`

**-25, -43, 100**

Factory Preset: Selected EDGE standard

Range: 200 dB to -100 dB, relative to the reference power

Default Unit: dB

Remarks: You must be in GSM, EDGE mode to use this command.  
Use INSTRument:SElect to set the mode.

### EDGE Power vs. Time—Upper Mask Time Points

```
[ :SENSe ] :EPVTime:MASK:LIST:UPPer:TIME  
<seconds>, <seconds>, <seconds>, <seconds>, <seconds>, . . .
```

```
[ :SENSe ] :EPVTime:MASK:LIST:UPPer:TIME?
```

Enter the time points that define the horizontal line segments of the upper limit. A reference point designated “ $t_0$ ” is at the center of the useful data (usually the center of the burst). Each line segment to the right of the  $t_0$  reference point is designated as a positive value and each segment to the left of  $t_0$  is a negative value.

First enter positive values in sequence starting from  $t_0$ , then the negative values in sequence starting from  $t_0$ . See [Figure 1 on page 411](#) and the EPVT:MASK:LIST:UPPER:TIME example below it.

We recommend that you select a large time value for your first and last mask points (e.g. -1 and +1 second). This guarantees that you’ve defined a limit for all the measured data. (See Mask Segments 4 and 9 in the [Table on page 411](#) for an example.

Example: **EPVT:MASK:LIST:UPP:TIME 280e-6, 15e-6, 1,  
-270e-6, -10e-6, -20e-6, -1**

Factory Preset: Selected EDGE standard

Range: -1s to +1s, referenced to  $t_0$  at the center of the useful data (burst center)

1 to 25 time points in a mask

Default Unit: seconds

Remarks: You must be in the GSM, EDGE mode to use this command. Use INSTRument:SElect to set the mode.

### EDGE Power vs. Time—Custom Limit Masks

```
[ :SENSe ] :EPVTime:MASK:SElect STANDARD|CUSTom
```

```
[ :SENSe ] :EPVTime:MASK:SElect?
```

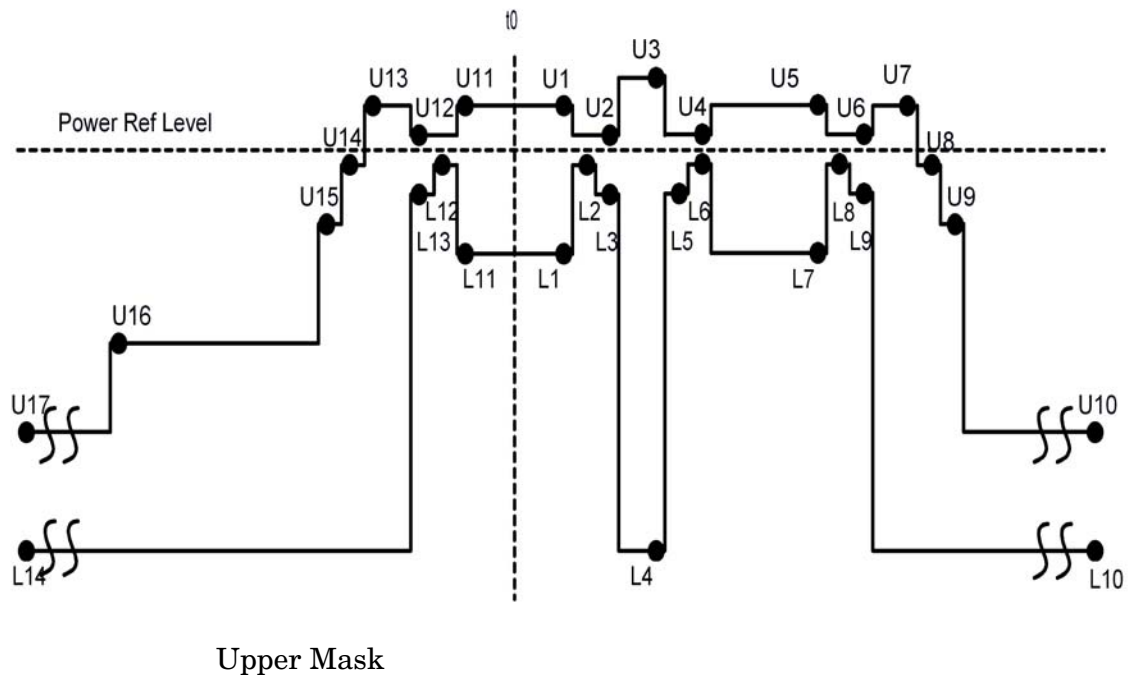
Select standard masks or user-defined custom masks against which to compare your measured data. See [“EDGE PvT Custom Limit Mask Example of Two Consecutive Bursts”](#) on page 413

Factory Preset: STANdard

Remarks: You must be in GSM, EDGE mode to use this command.  
Use INSTRument:SElect to set the mode.

### EDGE PvT Custom Limit Mask Example of Two Consecutive Bursts

**Figure 4-4** EDGE PvT Custom Limit Mask Example of Two Consecutive Bursts



Upper Mask

Segment Number	Timing	Relative Limit Level	Absolute Limit Level
U1	267.384615e-6	4.0	-200.0
U2	4.0e-6	2.4	-200.0
U3	33.23e-6	7.0	-200.0
U4	4.0e-6	2.4	-200.0
U5	534.76923e-6	4.0	-200.0
U6	4.0e-6	2.4	-200.0
U7	10.0e-6	4.0	-200.0

U8	8.0e-6	-6.0	-200.0
U9	10.0e-6	-30.0	-17.0
U10	1.0	-59.0	-54.0
U11	-267.384615e-6	4.0	-200.0
U12	-4.0e-6	2.4	-200.0
U13	-10.0e-6	4.0	-200.0
U14	-8.0e-6	-6.0	-200.0
U15	-10.0e-6	-30.0	-17.0
U16	-576.0e-6	-59.0	-36.0
U17	-1.0	-59.0	-54.0

Lower Mask

Segment Number	Timing	Relative Limit Level	Absolute Limit Level
L1	267.384615e-6	-20.0	-200.0
L2	2.0e-6	0.0	-200.0
L3	2.0e-6	-2.0	-200.0
L4	33.23e-6	-200.0	-200.0
L5	2.0e-6	-2.0	-200.0
L6	2.0e-6	0.0	-200.0
L7	534.76923e-6	-20.0	-200.0
L8	2.0e-6	0.0	-200.0
L9	2.0e-6	-2.0	-200.0
L10	1.0	-200.0	-200.0
L11	-267.384615e-6	-20.0	-200.0
L12	-2.0e-6	0.0	-200.0
L13	-2.0e-6	-2.0	-200.0
L14	-1.0	-200.0	-200.0

*Sample SCPI Sequence to Define The Above Mask*

```

:SENSe:EPVTime:MASK:SElect CUST
:SENSe:EPVTime:SWEep:TIME 3
:SENSe:EPVTime:MASK:LIST:UPPer:TIME 267.384615e-6, 4.0e-6,
33.23e-6, 4.0e-6, 534.76923e-6, 4.0e-6, 10.0e-6, 8.0e-6, 10.0e-6, 1.0,
-267.384615e-6, -4.0e-6, -10.0e-6, -8.0e-6, -10.0e-6, -576.0e-6, -1.0
:SENSe:EPVTime:MASK:LIST:UPPer:RELative 4.0, 2.4, 7.0, 2.4, 4.0,
2.4, 4.0, -6.0, -30.0, -59.0,4.0, 2.4, 4.0, -6.0, -30.0, -59.0, -59.0
:SENSe:EPVTime:MASK:LIST:UPPer:ABSolute -200.0, -200.0, -200.0,
-200.0, -200.0, -200.0, -200.0, -17.0, -54.0, -200.0, -200.0, -200.0,
-200.0, -17.0, -36.0, -54.0
:SENSe:EPVT:MASK:LIST:LOWer:TIME 267.384615e-6, 2.0e-6, 2.0e-6,
33.23e-6, 2.0e-6, 2.0e-6, 534.76923e-6, 2.0e-6, 2.0e-6, 1.0,
-267.384615e-6, -2.0e-6, -2.0e-6, -1.0
:SENSe:EPVTime:MASK:LIST:LOWer:RELative -20.0, 0.0, -2.0, -200.0,
-2.0, 0.0, -20.0, 0.0, -2.0, -200.0, -20.0, 0.0, -2.0, -200.0
:SENSe:EPVTime:MASK:LIST:LOWer:ABSolute -200.0, -200.0, -200.0,
-200.0, -200.0, -200.0, -200.0, -200.0, -200.0, -200.0, -200.0,
-200.0, -200.0

```

**EDGE Power vs Time - Select Power Control Level**

Allows user to indicate the output power of the transmitter; in MS testing transmitter output power level will affect the mask. The appropriate power level for measuring the device under test will correspond with the transmitter power control level setting.

**[ :SENSe ] :EPVTime:PCLevel <integer>**

**[ :SENSe ] :EPVTime:PCLevel?**

Range: 0 to 40

Remarks: You must be in GSM, EDGE mode to use this command.  
Use INSTRument:SElect to set the mode

Front Panel Access: **Meas Setup, More (1 of 2), Pwr Cntrl Lvl.**

**EDGE Power vs. Time—Sweep Time**

**[ :SENSe ] :EPVTime:SWEep:TIME <integer>**

**[ :SENSe ] :EPVTime:SWEep:TIME?**

Set the number of slots which are used in each data acquisition. Each

slot is approximately equal to 570  $\mu$ s. The measurement is made for a small additional amount of time (about 130  $\mu$ s) in order to view the burst edges.

Factory Preset: 1

Range: 1 to 8 (for resolution BW = 500 kHz)

Remarks: You must be in the GSM, EDGE mode to use this command. Use INSTRument:SElect to set the mode.

### EDGE Power vs. Time—Trigger Source

*For VSA, PSA:*

```
[ :SENSe ] :EPVTime:TRIGger:SOURce EXTeRnal [1] | EXTeRnal2  
| FRAMe | IF | IMMEdiate | RFBurst
```

```
[ :SENSe ] :EPVTime:TRIGger:SOURce?
```

*For ESA:*

```
[ :SENSe ] :EPVTime:TRIGger:SOURce RFBurst | EXTeRnal | FRAMe
```

```
[ :SENSe ] :EPVTime:TRIGger:SOURce?
```

Select the trigger source used to control the data acquisitions.

EXTeRnal 1 - front panel external trigger input

EXTeRnal 2 - rear panel external trigger input

FRAMe - uses the internal frame timer, which has been synchronized to the selected burst sync.

IF - internal IF envelope (video) trigger

IMMEdiate - the next data acquisition is immediately taken, capturing the signal asynchronously (also called Free Run).

RFBurst - wideband RF burst envelope trigger that has automatic level control for periodic burst signals.

EXTeRnal - rear panel external trigger input

Factory Preset: RFBurst for VSA, PSA

RFBurst for ESA when options B7E/B7D are present

EXTeRnal for ESA without Options B7E/B7D

Remarks: You must be in the GSM, EDGE mode to use this command. Use INSTRument:SElect to set the mode.

---

#### NOTE

Option B7E: RF Comms Hardware has at least three possible part numbers. Press **System, More, Show Hdwr** to show your instrument's RF Comms Hardware and view the part number. If the part number is



E4401-60087 (the original version), the RF Burst trigger source will not be available with this measurement, and the default will be **EXTernal**.

---

## EDGE Transmit Band Spurs Measurement

Commands for querying the EDGE transmit band spurs measurement results and for setting to the default values are found in the “[MEASure Group of Commands](#)” on page 519. The equivalent front panel keys for the parameters described in the following commands, are found under the **Meas Setup** key, after the **EDGE TxBand Spur** measurement has been selected from the **MEASURE** key menu.

History: E4406A:  
The EDGE version of the GSM transmit band spurs measurement was added in version A.05.00

### Transmit Band Spurs—Average Count

**[ :SENSe ] :ETSPur :AVERAge :COUNT <integer>**

**[ :SENSe ] :ETSPur :AVERAge :COUNT ?**

Set the number of data acquisitions that will be averaged. After the specified number of average counts, the averaging mode (termination control) setting determines the averaging action.

Factory Preset: 30

Range: 1 to 10,000

Remarks: You must be in GSM, EDGE mode to use this command.  
Use INSTRument:SElect to set the mode.

### Transmit Band Spurs—Averaging State

**[ :SENSe ] :ETSPur :AVERAge [ :STATe ] OFF | ON | 0 | 1**

**[ :SENSe ] :ETSPur :AVERAge [ :STATe ] ?**

Turn averaging on or off.

Factory Preset: ON

Remarks: You must be in GSM, EDGE mode to use this command.  
Use INSTRument:SElect to set the mode.

### Transmit Band Spurs—Averaging Termination Control

**[ :SENSe ] :ETSPur :AVERAge :TCONtrol EXPonential | REPeat**

**[ :SENSe ] :ETSPur :AVERAge :TCONtrol ?**

Select the type of termination control used for the averaging function. This determines the averaging action after the specified number of data acquisitions (average count) is reached.

EXPonential - After the average count has been reached, each

successive data acquisition is exponentially weighted and combined with the existing average.

REPeat - After reaching the average count, the averaging is reset and a new average is started.

Factory Preset: REPeat

Remarks: You must be in GSM, EDGE mode to use this command.  
Use INSTRument:SElect to set the mode.

### Transmit Band Spurs—Averaging Type

**[ :SENSe ] :ETSPur :AVERage :TYPE LOG | MAXimum | RMS**

**[ :SENSe ] :ETSPur :AVERage :TYPE?**

Select the type of averaging.

LOG - The log of the power is averaged. (This is also known as video averaging.)

MAXimum - The maximum values are retained.

RMS - The power is averaged, providing the rms of the voltage.

Factory Preset: MAXimum

Remarks: You must be in GSM, EDGE mode to use this command.  
Use INSTRument:SElect to set the mode.

### Transmit Band Spurs—Type

**[ :SENSe ] :ETSPur :TYPE EXAMine | FULL**

**[ :SENSe ] :ETSPur :TYPE?**

Select the measurement type.

EXAMine - measures spurs in all the valid segments and then displays the segment that has the worst spur

FULL - continuously measures the spurs in all the valid segments

Factory Preset: FULL

Remarks: You must be in GSM, EDGE mode to use this command.  
Use INSTRument:SElect to set the mode.

## RF Input Signal Alignments

### Select the Input Signal

PSA:

```
[ :SENSe ] :FEED RF | AREFERENCE | IFALIGN | WBALIGN
```

E4406A:

```
[ :SENSe ] :FEED RF | IQ | IONLY | QONLY | AREFERENCE | IFALIGN
```

```
[ :SENSe ] :FEED?
```

Selects the input signal. The default input signal is taken from the front panel RF input port. For calibration and testing purposes the input signal can be taken from an internal 321.4 MHz IF alignment signal or an internal 50 MHz amplitude reference source.

For E4406A if the baseband IQ option (Option B7C) is installed, I and Q input ports are added to the front panel. The I and Q ports accept the in-phase and quadrature components of the IQ signal, respectively. The input signal can be taken from either or both ports.

RF selects the signal from the front panel RF INPUT port.

IQ selects the combined signals from the front panel optional I and Q input ports. (E4406A with Option B7C in Basic, W-CDMA, cdma2000, EDGE(w/GSM) modes)

IONLY selects the signal from the front panel optional I input port. (E4406A with Option B7C in Basic mode)

QONLY selects the signal from the front panel optional Q input port. (E4406A with Option B7C in Basic mode)

AREFERENCE selects the internal 50 MHz amplitude reference signal.

IFALIGN selects the internal, 321.4 MHz, IF alignment signal.

WBALIGN selects the internal IF alignment signal for the wide bandwidth hardware path.

(PSA with Option 122 in Basic mode)

Factory Preset: RF

Front Panel

Access: **Input, Input Port**

Remarks: To use this command for E4406A, the appropriate mode should be selected with INSTRUMENT:SELEct.

For PSA you must be in the Basic, cdmaOne, cdma2000, 1xEV-DO, W-CDMA, GSM, EDGE, NADC, or PDC mode to use this command. Use INSTRUMENT:SELEct to set the mode.

History: E4406A: modified in version A.05.00.  
PSA modified in version A.06.00.

## Frequency Commands

### Center Frequency

**[ :SENSe ] :FREQuency:CENTer <freq>**

**[ :SENSe ] :FREQuency:CENTer?**

Set the center frequency.

Factory Preset: PSA

E4443A: 3.35 GHz for SA

E4445A: 6.5 GHz for SA

E4440A: 13.25 GHz for SA

1.0 GHz for Basic, cdmaOne, cdma2000, W-CDMA,  
NADC, PDC modes

935.2 MHz for GSM, EDGE modes

Factory Preset: 1.0 GHz

942.6 MHz for GSM, EDGE

806.0 MHz for iDEN

Range: PSA

E4443A: 3 Hz to 6.7 GHz for SA

E4445A: 3 Hz to 13.2 GHz for SA

E4440A: 3 Hz to 26.5 GHz for SA

3 Hz to 1.5 GHz for Basic, cdmaOne, cdma2000,  
W-CDMA, GSM, EDGE, NADC, PDC modes  
(Measurement specifications are only applicable up  
to 3 GHz.)

Range: 1.0 kHz to 4.3214 GHz

Default Unit: Hz

Front Panel

Access: **FREQUENCY/Channel, Center Freq**

### Center Frequency Step Size

**[ :SENSe ] :FREQuency:CENTer:STEP [ :INCRement ] <freq>**

**[ :SENSe ] :FREQuency:CENTer:STEP [ :INCRement ] ?**

Specifies the center frequency step size.

Factory Preset: 5.0 MHz (E4406A)

1.25 MHz for cdma2000 (E4406A)  
 Range: 1.0 kHz to 1.0 GHz, in 10 kHz steps (E4406A)  
 Default Unit: Hz  
 History: E4406A:  
 Version A.03.00 or later  
 Front Panel  
 Access: **FREQUENCY/Channel, CF Step**

## GMSK Output RF Spectrum Measurement

Commands for querying the output RF spectrum measurement results and for setting to the default values are found in the “[MEASure Group of Commands](#)” on page 519. The equivalent front panel keys for the parameters described in the following commands, are found under the **Meas Setup** key, after the **GMSK Output RF Spectrum** measurement has been selected from the **MEASURE** key menu.

### GMSK ORFS - Custom Modulation Apply Limit Level Offsets

```
[ :SENSe ] :ORFSpectrum:LIST:MODulation:APPLY
RELative | BOTH | ABSolute { , RELative | BOTH | ABSolute }
```

```
[ :SENSe ] :ORFSpectrum:LIST:MODulation:APPLY?
```

Name:	Custom Modulation Apply Limit Level Offsets
Key Path:	<b>Meas Setup, 5</b>
Default:	BOTH, BOTH, BOTH, BOTH, BOTH, BOTH, BOTH, BOTH, BOTH, BOTH, BOTH, BOTH, BOTH, BOTH, BOTH
State Saved:	Saved in instrument state.
Range:	Rel   Both   Abs
Example:	:SENSe:ORFSpectrum:LIST:MODulation:APPLY RELative, RELative, RELative

Array Length: Any number from 1 to 15 is acceptable as long as the following arrays have the same number of elements:

Custom Switching Offset Frequency  
Custom Switching Resolution Band Width  
Custom Switching Relative Limit Level Offsets  
Custom Switching Absolute Limit Level Offsets  
Custom Switching Apply Limit Level Offsets

### GMSK Output RF Spectrum—Number of Bursts Averaged

**[ :SENSe ] :ORFSpectrum:AVERage:COUNT <integer>**

**[ :SENSe ] :ORFSpectrum:AVERage:COUNT?**

Set the number of bursts that will be averaged. For the output RF spectrum due to switching transients, it is more accurate to consider this the number of frames that are measured. After the specified number of bursts (average counts), the averaging mode (termination control) setting determines the averaging action.

Factory Preset: 15

Range: 1 to 10,000

Remarks: You must be in the GSM, EDGE mode to use this command. Use INSTRument:SElect to set the mode.

### GMSK Output RF Spectrum—Fast Averaging

**[ :SENSe ] :ORFSpectrum:AVERage:FAST[:STATe] OFF|ON|0|1**

**[ :SENSe ] :ORFSpectrum:AVERage:FAST[:STATe]?**

Make the measurement faster by using an averaging technique different from that defined by the standard. A valid average can be obtained by measuring the power in half the normal number of bursts by using 50% - 90% of the burst, 10% - 50% of the burst and excluding the midamble.

This faster averaging is only done when averaging is on and only the modulation results are being measured. If both modulation and switching transients results are being measured, then the measurement uses the default averaging.

Factory Preset: ON

Remarks: You must be in the GSM, EDGE mode to use this command. Use INSTRument:SElect to set the mode.



### GMSK Output RF Spectrum—Averaging Type for Modulation Spectrum

**[ :SENSe ] :ORFSpectrum:AVERAge:MODulation:TYPE LOG | RMS**

**[ :SENSe ] :ORFSpectrum:AVERAge:MODulation:TYPE?**

Select the type of averaging for measuring the modulation spectrum. This is an advanced control that normally does not need to be changed. Setting this to a value other than the factory default, may cause invalid measurement results.

LOG - The log of the power is averaged. (This is also known as video averaging.)

RMS - The power is averaged, providing the rms of the voltage.

Factory Preset: LOG

Remarks: You must be in the GSM, EDGE mode to use this command. Use INSTRument:SElect to set the mode.

### GMSK Output RF Spectrum—Averaging Control

**[ :SENSe ] :ORFSpectrum:AVERAge [ :STATE ] OFF | ON | 0 | 1**

**[ :SENSe ] :ORFSpectrum:AVERAge [ :STATE ] ?**

Turn averaging on or off.

Factory Preset: ON

Remarks: You must be in the GSM, EDGE mode to use this command. Use INSTRument:SElect to set the mode.

### GMSK Output RF Spectrum—Averaging Type for Switching Transient Spectrum Query

**[ :SENSe ] :ORFSpectrum:AVERAge:SWITChing:TYPE?**

Queries the type of averaging for measuring the switching transient spectrum.

Factory Preset: MAXP (maximum peak power)

Remarks: You must be in the GSM, EDGE mode to use this command. Use INSTRument:SElect to set the mode.

History: E4406A:  
Query only format adopted for version A.05.00.

### GMSK Output RF Spectrum—Resolution BW for the Modulation Spectrum at the Carrier

```
[ :SENSe ] :ORFSpectrum:BA NDwidth|BWIDth[:RESolution]  
:MODulation:CA RRier <freq>
```

```
[ :SENSe ] :ORFSpectrum:BA NDwidth|BWIDth[:RESolution]  
:MODulation:CA RRier?
```

Selects the resolution bandwidth for measuring the carrier when measuring spectrum due to modulation and wideband noise.

This parameter is only used with the Standard or Short lists, and not with the Custom list.

Factory Preset: 30 kHz

Range: 1 kHz to 5 MHz

Default Unit: Hz

Remarks: You must be in the GSM, EDGE mode to use this command. Use INSTRument:SElect to set the mode.

### GMSK Output RF Spectrum—Resolution BW For Modulation At Close Offsets

```
[ :SENSe ] :ORFSpectrum:BA NDwidth|BWIDth[:RESolution]  
:MODulation:OFFSet:CL OSe <freq>
```

```
[ :SENSe ] :ORFSpectrum:BA NDwidth|BWIDth[:RESolution]  
:MODulation:OFFSet:CL OSe?
```

Set the resolution bandwidth used for the spectrum due to modulation part of the ORFS measurement for offset frequencies less than 1800 kHz.

This parameter is only used with the Standard or Short lists, and not with the Custom list.

Factory Preset: 30 kHz

Range: 1 kHz to 5 MHz

Default Unit: Hz

Remarks: You must be in the GSM, EDGE mode to use this command. Use INSTRument:SElect to set the mode.

### GMSK Output RF Spectrum—Resolution BW for Modulation at Far Offsets

```
[ :SENSe ] :ORFSpectrum:BA NDwidth|BWIDth[:RESolution]  
:MODulation:OFFSet:FA R <freq>
```

```
[ :SENSE]:ORFSpectrum:BANDwidth|BWIDth[:RESolution]
:MODulation:OFFSet:FAR?
```

Set the resolution bandwidth used for the spectrum due to modulation part of the ORFS measurement for offset frequencies greater than or equal to 1800 kHz.

For E4406A this parameter is only used with the Standard or Short lists, and not with the Custom list.

Factory Preset: 100 kHz

Range: 1 kHz to 5 MHz

Default Unit: Hz

Remarks: You must be in the GSM, EDGE mode to use this command. Use INSTRument:SElect to set the mode.

### GMSK Output RF Spectrum—Resolution BW for the Switching Transient Spectrum at the Carrier

```
[ :SENSE]:ORFSpectrum:BANDwidth|BWIDth[:RESolution]
:SWITching:CARRier <freq>
```

```
[ :SENSE]:ORFSpectrum:BANDwidth|BWIDth[:RESolution]
:SWITching:CARRier?
```

Selects the resolution bandwidth for the carrier when measuring spectrum due to switching transients.

This parameter is only used with the Standard or Short lists, and not with the Custom list.

Factory Preset: 300 kHz

Range: 1 kHz to 5 MHz

Default Unit: Hz

Remarks: You must be in the GSM, EDGE mode to use this command. Use INSTRument:SElect to set the mode.

### GMSK Output RF Spectrum—Resolution BW For Switching Transients At Close Offsets

```
[ :SENSE]:ORFSpectrum:BANDwidth|BWIDth[:RESolution]
:SWITching:OFFSet:CLOSe <freq>
```

```
[ :SENSE]:ORFSpectrum:BANDwidth|BWIDth[:RESolution]
:SWITching:OFFSet:CLOSe?
```

Set the resolution bandwidth used for the spectrum due to switching transients part of the ORFS measurement for offset frequencies less

than 1800 kHz.

This parameter is only used with the Standard or Short lists, and not with the Custom list.

Factory Preset: 30 kHz

Range: 1 kHz to 5 MHz

Default Unit: Hz

Remarks: You must be in the GSM, EDGE mode to use this command. Use INSTRument:SElect to set the mode.

### GMSK Output RF Spectrum—Resolution BW For Switching Transients At Far Offsets

```
[ :SENSe ] :ORFSpectrum: BANDwidth | BWIDth [ :RESolution ]  
:SWITching: OFFSet: FAR <freq>
```

```
[ :SENSe ] :ORFSpectrum: BANDwidth | BWIDth [ :RESolution ]  
:SWITching: OFFSet: FAR?
```

Set the resolution bandwidth used for the spectrum due to switching transients part of the ORFS measurement for offset frequencies greater than or equal to 1800 kHz.

This parameter is only used with the standard or short lists, and not with the custom list.

Factory Preset: 30 kHz

Range: 1 kHz to 5 MHz

Default Unit: Hz

Remarks: You must be in the GSM, EDGE mode to use this command. Use INSTRument:SElect to set the mode.

### GMSK Output RF Spectrum—Break Frequency

```
[ :SENSe ] :ORFSpectrum: BFRrequency <freq>
```

```
[ :SENSe ] :ORFSpectrum: BFRrequency?
```

Set the direct time break frequency. An FFT measurement method is used for offsets below this break frequency. The direct time measurement method is used for offsets above the break frequency. See the chapter on making measurements for more information about these two methods.

Factory Preset: 600 kHz

Range: 0 kHz to 775 kHz

Default Unit: Hz  
 History: E4406A:  
 Added revision A.04.00 and later  
 Remarks: You must be in the GSM, EDGE mode to use this command. Use INSTRument:SElect to set the mode.  
 Front Panel  
 Access: Meas Setup, Advanced, Direct Time Break Freq

### GMSK Output RF Spectrum—Peak Detection mode

**[ :SENSe] :ORFSpectrum:DETEctor:SWITching:FAST [ :STATE] OFF|ON|0|1**

**[ :SENSe] :ORFSpectrum:DETEctor:SWITching?**

Sets the detection mode to “fast peak”. This setting is available when “measurement type” selected is Switching or Switching & Modulation.

Factory Preset: On

Remarks: You must be in the GSM, EDGE mode to use this command. Use INSTRument:SElect to set the mode.

Front Panel

Access: Meas Setup, More (1 of 2), Advanced

State Saved: Saved in Instrument State

### GMSK Output RF Spectrum—Define Custom Modulation Resolution Bandwidth List

**[ :SENSe] :ORFSpectrum:LIST:MODulation:BANDwidth|BWIDth <res bw>{, <res bw>}**

**[ :SENSe] :ORFSpectrum:LIST:MODulation:BANDwidth|BWIDth?**

Define the custom set of resolution bandwidths for the modulation spectrum part of the ORFS measurement. The first bandwidth specified is for the carrier. Each resolution bandwidth in this list corresponds to an offset frequency in the modulation offset frequency list. The number of items in each of these lists needs to be the same.

Factory Preset: Same as standard list

Range: 1 kHz to 5 MHz

Default Unit: Hz

Remarks: This command is only valid if SENS:ORFS:MEAS is set to multiple and the custom list type is selected with SENS:ORFS:LIST:SEL CUST.

You must be in the GSM, EDGE mode to use this command. Use INSTRument:SElect to set the mode.

### GMSK Output RF Spectrum—Define Custom Modulation Level Offsets

```
[[:SENSe]:ORFSpectrum:LIST:MODulation:LOFFset[:RCARrier]  
<level>{,<level>}
```

```
[[:SENSe]:ORFSpectrum:LIST:MODulation:LOFFset[:RCARrier]?
```

Define the custom set of level offsets for the modulation spectrum part of the ORFS measurement. This allows you to modify the standard limits by adding a delta amplitude value to them. The first level offset specified must be 0 dB for the carrier. Each level offset in this list corresponds to an offset frequency in the modulation offset frequency list. The number of items in each of these lists needs to be the same.

**Example:**      `ORFS:LIST:MOD:FREQ 0,300e3,1.3e6,2.0e6`

Sets custom offset freqs: 300 kHz, 1.3 MHz, 2 MHz

```
ORFS:LIST:MOD:BAND 30e3,30e3,30e3,100e3
```

Sets corresponding RBWs: 30 kHz, 30 kHz, 100 kHz

```
ORFS:LIST:MOD:LOFFset 0,-5,3,5
```

Assume the power level of the signal is -43 dBm, then the standard limits for these three offsets are: -42 dBc, -72 dBc, -75 dBc respectively. The loffset command adjusts these limits to: -47 (-42-5) dBc, -70 (-73+3) dBc, -70 (-75+5) dBc.

**Factory Preset:** 0 dB level offsets (limits remain the same as the standards)

**Range:** 0 to 50 dB

**Default Unit:** dB

**Remarks:** This command is only valid if SENS:ORFS:MEAS is set to multiple and the custom list type is selected with SENS:ORFS:LIST:SEL CUST.

You must be in the GSM, EDGE mode to use this command. Use INSTRument:SElect to set the mode.

**History:** E4406A:  
Version A.03.00 or later

### GMSK ORFS - Custom Modulation Absolute Limit Level Offsets

```
[[:SENSe]:ORFSpectrum:LIST:MODulation:LOFFset:ABSolute
```

**<level>{,<level>}**

**[ :SENSE ] :ORFSpectrum:LIST:MODulation:LOFFset:ABSolute?**

Name:	Custom Modulation Absolute Limit Level Offsets
Key Path:	<b>Meas Setup, 5</b>
Unit:	DB
Default:	0.0
State Saved:	Saved in instrument state.
Resolution:	0.1 dB
Example:	:SENSE:ORFSpectrum:LIST:MODulation:LOFFset:ABSolute 0.0, -2.0, -5.0
Array Length:	Any number from 1 to 15 is acceptable as long as the following arrays have the same number of elements:  Custom Switching Offset Frequency Custom Switching Resolution Band Width Custom Switching Relative Limit Level Offsets Custom Switching Absolute Limit Level Offsets Custom Switching Apply Limit Level Offsets

### GMSK ORFS - Custom Modulation State

**[ :SENSE ] :ORFSpectrum:LIST:MODulation[ :FREQUENCY ] <offset freq>{,<offset freq>}**

**[ :SENSE ] :ORFSpectrum:LIST:MODulation[ :FREQUENCY ] ?**

**[ :SENSE ] :ORFSpectrum:LIST:MODulation:STATE  
OFF | ON | 0 | 1 { , OFF | ON | 0 | 1 }**

**[ :SENSE ] :ORFSpectrum:LIST:MODulation:STATE?**

Name:	Custom Modulation Offset Freq
Key Path:	<b>Meas Setup, 5</b>
Active Function Text:	Offset Freq
Default Terminator:	Hz   kHz   MHz   GHz

Factory Presets:	
Frequency:	0.0, 1.0e5, 2.0e5, 2.5e5, 4.0e5, 6.0e5, 8.0e5, 1.0e6, 1.2e6, 1.4e6, 1.6e6, 1.8e6, 3.0e6, 6.0e6
State:	1, 1, 1, 1, 1, 1, 1, 1, 1, 1, 1, 1, 1, 1
State Saved:	Saved in instrument state.
SCPI Resolution:	1.0 Hz
Example:	:SENSe:ORFSpectrum:LIST:MODulation:FREQ uency 0.0, 1.0e5, 2.0e5  :SENSe:ORFSpectrum:LIST:MODulation:STAT e ON, ON, ON
Array Length:	Any number from 1 to 15 is acceptable as long as the following arrays have the same number of elements:  Custom Switching Offset Frequency Custom Switching Resolution Band Width Custom Switching Relative Limit Level Offsets Custom Switching Absolute Limit Level Offsets Custom Switching Apply Limit Level Offsets

### GMSK Output RF Spectrum—Offset Frequency List

**[[:SENSe]:ORFSpectrum:LIST:SElect CUSTOM|SHORT|STANDARD**

**[[:SENSe]:ORFSpectrum:LIST:SElect?**

Select the list of settings that will be used to make the ORFS measurement. This specifies standard or customized lists and short lists. The lists contain the offset frequencies (and bandwidths) that are used for the modulation spectrum and transient spectrum parts of the ORFS measurement.

CUSTOM - uses the four user-defined lists that specify:

- Offset frequencies for modulation spectrum measurement
- Corresponding resolution bandwidths for each of the modulation offset frequencies
- Offset frequencies for switching transient spectrum measurement
- Corresponding resolution bandwidths for each of the switching transient offset frequencies

SHORT - a shortened list of the offset frequencies specified in the GSM Standards. It uses two internal offset frequency lists, one for modulation spectrum and the other for switching transient spectrum. These offset frequencies cannot be changed, but the resolution bandwidths can be changed by other commands in the



SENSe:ORFSpectrum subsystem.

STANdard - the complete list of the offset frequencies specified in the GSM Standards, except for those offsets greater than 6 MHz. It uses two internal offset frequency lists, one for modulation spectrum and the other for switching transient spectrum. These offset frequencies cannot be changed, but the resolution bandwidths can be changed by other commands in the SENSe:ORFSpectrum subsystem.

Factory Preset: SHORT

Remarks: This command is only valid if SENS:ORFS:MEAS is set to multiple.

If you change the number of custom offsets then the number of offset bandwidths, frequencies and level offsets must also be changed.

You must be in the GSM, EDGE mode to use this command. Use INSTRument:SElect to set the mode.

### GMSK ORFS - Custom Switching Apply Limit Level Offsets

**[ :SENSe ] :ORFSpectrum:LIST:SWITching:APPLy**  
**<RELative | BOTH | ABSolute> { , <RELative | BOTH | ABSolute> }**

**[ :SENSe ] :ORFSpectrum:LIST:SWITching:APPLy?**

Name:	Custom Switching Apply Limit Level Offsets
Key Path:	<b>Meas Setup, 5</b>
Default:	BOTH, BOTH, BOTH, BOTH, BOTH, BOTH, BOTH, BOTH, BOTH, BOTH, BOTH, BOTH, BOTH, BOTH, BOTH
State Saved:	Saved in instrument state.
Range:	Rel   Both   Abs
Example:	:SENSe:ORFSpectrum:LIST:SWITching:APPLy RELative, RELative, RELative

Array Length: Any number from 1 to 15 is acceptable as long as the following arrays have the same number of elements:

Custom Switching Offset Frequency  
Custom Switching Resolution Band Width  
Custom Switching Relative Limit Level Offsets  
Custom Switching Absolute Limit Level Offsets  
Custom Switching Apply Limit Level Offsets

### GMSK Output RF Spectrum—Define Custom Switching Transient Resolution Bandwidth List

```
[ :SENSe ] :ORFSpectrum:LIST:SWITching:BA NDwidth | BWIDTh  
<res_bw> { , <res_bw> }
```

```
[ :SENSe ] :ORFSpectrum:LIST:SWITching:BA NDwidth | BWIDTh?
```

Define the custom set of resolution bandwidths for the switching transient spectrum part of the ORFS measurement. The first bandwidth specified is for the carrier. Each resolution bandwidth in this list corresponds to an offset frequency in the switching transient offset frequency list. The number of items in each of these lists needs to be the same.

Factory Preset: Same as standard list

Range: 1 kHz to 5 MHz

Default Unit: Hz

Remarks: This command is only valid if SENS:ORFS:MEAS is set to multiple and the custom list type is selected with SENS:ORFS:LIST:SEL CUST.

You must be in GSM, EDGE mode to use this command.  
Use INSTRument:SElect to set the mode.

### GMSK Output RF Spectrum—Define Custom Switching Transient Relative Limit Level Offsets

```
[ :SENSe ] :ORFSpectrum:LIST:SWITching:LOFFset [ :RCARrier ]  
<level> { , <level> }
```

```
[ :SENSe ] :ORFSpectrum:LIST:SWITching:LOFFset [ :RCARrier ]?
```

Define the custom set of level offsets for the switching transient spectrum part of the ORFS measurement. This allows you to modify the standard limits by adding a delta amplitude value to them. The first

level offset specified must be 0 dB for the carrier. Each level offset in this list corresponds to an offset frequency in the modulation offset frequency list. The number of items in each of these lists needs to be the same.

Example: See the ORFS:LIST:MOD:LOFF example above.

Factory Preset: 0 dB level offsets (limits remain the same as the standards)

Range: 0 to 50 dB

Default Unit: dB

Remarks: This command is only valid if SENS:ORFS:MEAS is set to multiple and the custom list type is selected with SENS:ORFS:LIST:SEL CUST.

You must be in GSM, EDGE mode to use this command. Use INSTRUMENT:SELEct to set the mode.

History: E4406A:  
Version A.03.00 or later

### GMSK ORFS - Custom Switching Absolute Limit Level Offsets

[ :SENSe] :ORFSpectrum:LIST:SWITching:LOFFset:ABSolute  
<level>{, <level>}

[ :SENSe] :ORFSpectrum:LIST:SWITching:LOFFset:ABSolute?

Name: Custom Switching Absolute Limit Level Offsets

Key Path: Meas Setup, 5

Unit: DB

Default: 0.0

State Saved: Saved in instrument state.

Resolution: 0.1 dB

Example: :SENSe:ORFSpectrum:LIST:SWITching:LOFFset  
:ABSolute 0.0, -2.0, -5.0

Array Length: Any number from 1 to 15 is acceptable as long as the following arrays have the same number of elements:

- Custom Switching Offset Frequency
- Custom Switching Resolution Band Width
- Custom Switching Relative Limit Level Offsets
- Custom Switching Absolute Limit Level Offsets
- Custom Switching Apply Limit Level Offsets

### GMSK ORFS - Custom Switching State

```
[ :SENSe ] :ORFSpectrum:LIST:SWITching [ :FREQuency ] <offset freq> { , <offset freq> }
```

```
[ :SENSe ] :ORFSpectrum:LIST:SWITching [ :FREQuency ] ?
```

```
[ :SENSe ] :ORFSpectrum:LIST:SWITching:STATe  
OFF | ON | 0 | 1 { , OFF | ON | 0 | 1 }
```

```
[ :SENSe ] :ORFSpectrum:LIST:SWITching:STATe?
```

Name:	Custom Switching Offset Freq
Key Path:	<b>Meas Setup, 5</b>
Active Function Text:	Offset Freq
Default Terminator:	Hz   kHz   MHz   GHz
Factory Presets:	
Frequency:	0.0, 4.0e5, 6.0e5, 1.2e6, 1.8e6
State:	1, 1, 1, 1, 1
State Saved:	Saved in instrument state.
SCPI Resolution:	1.0 Hz
Example:	:SENSe:ORFSpectrum:LIST:SWITching:FREQuency 0.0, 1.0e5, 2.0e5 :SENSe:ORFSpectrum:LIST:SWITching:STATe ON, ON, ON

Array Length: Any number from 1 to 15 is acceptable as long as the following arrays have the same number of elements:

- Custom Switching Offset Frequency
- Custom Switching Resolution Band Width
- Custom Switching Relative Limit Level Offsets
- Custom Switching Absolute Limit Level Offsets
- Custom Switching Apply Limit Level Offsets

### **GMSK Output RF Spectrum—Measure Offsets Measurement Method**

**[ :SENSe ] :ORFSpectrum:MEASure?**

Select the measurement method to be used.

MULTiple - the measurement is done at all offsets in the offset frequency list.

SINGLE - the measurement is done at only one offset as determined by the offset frequency setting. This allows detailed examination of the time-domain waveform at the specified offset frequency.

Factory Preset: MULTiple

### **GMSK ORFS - Meas Method**

**[ :SENSe ] :ORFSpectrum:MEASure MULTiple|SINGLE|SWEPT**

**[ :SENSe ] :ORFSpectrum:MEASure?**

Select the measurement method to be used.

MULTiple - the measurement is done at all offsets in the offset frequency list.

SINGLE - the measurement is done at only one offset as determined by the offset frequency setting. This allows detailed examination of the time-domain waveform at the specified offset frequency.

SWEPT - the measurement is done in the frequency domain. For output RF spectrum due to modulation it is done using time-gated spectrum analysis to sweep the analyzer with the gate turned on for the desired portion of the burst only.

Parameter Name: Meas Method

Key Path:	<b>Meas Setup</b>
Factory Preset:	MULTiple ,
State Saved:	Saved in instrument state.
Range:	Multi-Offset   Single Offset (Examine)   Swept ,
Dependencies and Couplings:	Swept choice is available only if Meas Type is Modulation. Otherwise, the Swept choice is grayed out.  If Swept is selected and Meas Type is not Modulation, the measurement algorithm internally assumes that Meas Method is Multi-Offset.
Example:	:SENSe:ORFSpectrum:MEASure MULTiple

### GMSK Output RF Spectrum—Offset Frequency

**[ :SENSe ] :ORFSpectrum:OFRequency <freq>**

**[ :SENSe ] :ORFSpectrum:OFRequency?**

Set the offset frequency that is used to measure a single offset. This command is only valid if SENS:ORFS:MEAS is set to single.

Factory Preset: 250 kHz

Range: -12.0 MHz to +12.0 MHz

Step Size: Steps through the values in the selected offset frequency list.

Default Unit: Hz

Remarks: You must be in the GSM, EDGE mode to use this command. Use INSTRument:SElect to set the mode.

### GMSK Output RF Spectrum—Trigger Source

**[ :SENSe ] :ORFSpectrum:TRIGger:SOURce EXTernal [1] | EXTernal2 | FRAMe | IMMEDIATE | RFBurst**

**[ :SENSe ] :ORFSpectrum:TRIGger:SOURce?**

Select the trigger source used to control the data acquisitions.

EXTernal 1 - front panel external trigger input

EXTernal 2 - rear panel external trigger input

FRAMe - uses the internal frame timer, which has been synchronized to the selected burst sync

IMMEDIATE - the next data acquisition is immediately taken, capturing the signal asynchronously (also called free run)

RFBURST - wideband RF burst envelope trigger that has automatic level control for periodic burst signals

Factory Preset: RFBURST if the RF Communications Hardware (option B7E) has been installed

EXTERNAL if option B7E has not been installed

Remarks: You must be in the GSM, EDGE mode to use this command. Use INSTRUMENT:SELECT to set the mode.

### GMSK Output RF Spectrum—Measurement Type

**[ :SENSE ] :ORFSpectrum:TYPE**  
**MODulation | MSWitching | SWITching | FFModulation**

**[ :SENSE ] :ORFSpectrum:TYPE?**

Select the measurement type.

MODulation - only the modulation spectrum is measured.

MSWitching (Modulation & Switching) - both modulation and switching transient spectrums are measured.

SWITching - only the switching transient spectrum is measured.

FFModulation- full frame modulation improves measurement speed by acquiring a full frame of data prior to performing the FFT calculation. FFT modulation can only be used if all slots in the transmitted frame are active.

Factory Preset: MODulation

Remarks: You must be in the GSM, EDGE mode to use this command. Use INSTRUMENT:SELECT to set the mode.

History: Added in version A.05.00

### GMSK Phase & Frequency Error Measurement

Commands for querying the phase and frequency error measurement results and for setting to the default values are found in the [“MEASURE Group of Commands” on page 519](#). The equivalent front panel keys for the parameters described in the following commands, are found under the **Meas Setup** key, after the **GMSK Phase & Freq** measurement has been selected from the **MEASURE** key menu.

### Phase & Frequency Error—Number Of Bursts Averaged

**[ :SENSe ] :PFERror:AVERage:COUNT <integer>**

**[ :SENSe ] :PFERror:AVERage:COUNT?**

Set the number of bursts that will be averaged. After the specified number of bursts (average counts), the averaging mode (termination control) setting determines the averaging action.

Factory Preset: 15

Range: 1 to 1,000

Remarks: You must be in the GSM, EDGE mode to use this command. Use INSTRument:SELEct to set the mode.

### Phase & Frequency Error—Averaging State

**[ :SENSe ] :PFERror:AVERage [ :STATe ] OFF | ON | 0 | 1**

**[ :SENSe ] :PFERror:AVERage [ :STATe ] ?**

Turn averaging on or off.

Factory Preset: OFF

Remarks: You must be in the GSM, EDGE mode to use this command. Use INSTRument:SELEct to set the mode.

### Phase & Frequency Error—Averaging Termination Control

**[ :SENSe ] :PFERror:AVERage:TCONtrol EXPonential | REPEAT**

**[ :SENSe ] :PFERror:AVERage:TCONtrol?**

Select the type of termination control used for the averaging function. This determines the averaging action after the specified number of bursts (average count) is reached.

EXPonential - After the average count has been reached, each successive data acquisition is exponentially weighted and combined with the existing average.

REPEAT - After reaching the average count, the averaging is reset and a new average is started.

Factory Preset: REPEAT

Remarks: You must be in the GSM, EDGE mode to use this command. Use INSTRument:SELEct to set the mode.



### Phase & Frequency Error—Averaging Type

**[ :SENSE ] :PFError:AVERage:TYPE MEAN|MAXimum**

**[ :SENSE ] :PFError:AVERage:TYPE?**

Select the type of averaging:

MEAN - the scalar results are averaged.

MAXimum - the maximum scalar results are retained.

Factory Preset: MAXimum.

Remarks: For E4406A you must be in GSM, EDGE mode to use this command. Use INSTRument:SElect to set the mode.

Remarks: For PSA you must be in the GSM, or EDGE mode to use this command. Use INSTRument:SElect to set the mode.

### Phase & Frequency Error—I/Q Origin Offset Measurement

**[ :SENSE ] :PFError:IQOffset [ :STATE ] OFF|ON|0|1**

**[ :SENSE ] :PFError:IQOffset [ :STATE ] ?**

Turn On or Off I/Q origin offset measurement. If it is set to On, I/Q origin offset is performed. When it is set to Off, the measurement is not performed, but the measurement speed is improved.

Factory Preset: On

On - I/Q origin offset measurement is performed.

Off - I/Q origin offset measurement is not performed.

Remarks: You must be in the GSM, EDGE mode to use this command. Use INSTRument:SElect to set the mode.

### Phase & Frequency Error—Burst Synchronization

**[ :SENSE ] :PFError:BSync:SOURce**

**EXTernal [1] |EXTernal2 |NONE |RFBurst |TSEquence**

**[ :SENSE ] :PFError:BSync:SOURce?**

Select the method of synchronizing the measurement to the GSM bursts.

EXTernal 1 - burst sync at front panel external trigger input

EXTernal 2 - burst sync at rear panel external trigger input

Training Sequence (TSEquence) - the training sequence burst sync

performs a demodulation of the burst and determines the start and stop of the useful part of the burst based on the midamble training sequence.

RFBurst - the RF amplitude burst sync approximates the start and stop of the useful part of the burst without demodulation of the burst.

None - no burst synchronization is used

Factory Preset: TSEquence

Remarks: You must be in the GSM, EDGE mode to use this command. Use INSTRument:SElect to set the mode.

### Phase & Frequency Error—Trace Data

```
[ :SENSe ] :PFERror:TRACe [ :STATe ] OFF | ON | 0 | 1
```

```
[ :SENSe ] :PFERror:TRACe [ :STATe ] ?
```

Turn On or Off trace data for phase and frequency error measurement. If it is set to On, the trace data is available. When it is set to Off, the trace data is not available, but the measurement speed is improved.

Factory Preset: On

On - Trace data is available.

Off - Trace data is not available.

Remarks: You must be in the GSM, EDGE mode to use this command. Use INSTRument:SElect to set the mode.

### Phase & Frequency Error—Trigger Source

```
[ :SENSe ] :PFERror:TRIGger:SOURce EXTernal [ 1 ] | EXTernal2  
| FRAMe | IF | IMMEDIATE | RFBURSt
```

```
[ :SENSe ] :PFERror:TRIGger:SOURce?
```

Select the trigger source used to control the data acquisitions.

EXTernal 1 - front panel external trigger input.

EXTernal 2 - rear panel external trigger input.

FRAMe - uses the internal frame timer, which has been synchronized to the selected burst sync.

IF - internal IF envelope (video) trigger.

IMMEDIATE - the next data acquisition is immediately taken, capturing the signal asynchronously (also called free run).

RFBurst - wideband RF burst envelope trigger that has automatic level control for periodic burst signals.

Factory Preset: RFBurst

Remarks: You must be in the GSM, EDGE mode to use this command. Use INSTRument:SElect to set the mode.

### Select I/Q Power Range (E4406A only)

```
[ :SENSe ] :POWER:IQ:RANGe [ :UPPer ] <Float 64> {DBM} | DBMV | W
```

```
[ :SENSe ] :POWER:IQ:RANGe [ :UPPer ] ?
```

Selects maximum total power expected from unit under test at test port when I or Q port is selected.

Range: For 50 Ohms:

13.0, 7.0, 1.0, -5.1 [DBM]  
60.0, 54.0, 48.0, 41.9 [DBMV]  
.02, .005, .0013, .00031 [W]

For 600 Ohms:

2.2, -3.8, -9.8, -15.8 [DBM]  
60.0, 54.0, 48.0, 41.9 [DBMV]  
.0017, .00042, .0001, .000026 [W]

Values for 1 M Ohm vary according to selected reference impedance.

Remarks: Implemented for BASIC and W-CDMA modes.

History: Version A.05.00 or later

### Select I/Q Voltage Range (E4406A only)

```
[ :SENSe ] :VOLTage:IQ:RANGe [ :UPPer ] <Float 64> [V]
```

```
[ :SENSe ] :VOLTage:IQ:RANGe [ :UPPer ] ?
```

Selects upper voltage range when I or Q port is selected. This setting helps set the gain which is generated in the variable gain block of the BbIQ board to improve dynamic range.

Range: 1.0, 0.5, .025, 0.125[V]

Remarks: Implemented for BASIC and W-CDMA modes.

History: Version A.05.00 or later

## RF Power Commands

### RF Port Input Attenuation

```
[ :SENSe ] :POWer [ :RF ] :ATTenuation <rel_power>
```

```
[ :SENSe ] :POWer [ :RF ] :ATTenuation?
```

Set the RF input attenuator. This value is set at its auto value if RF input attenuation is set to auto.

Factory Preset: 0 dB

12 dB for iDEN (E4406A)

Range: 0 to 40 dB

Default Unit: dB

Front Panel

Access: **Input, Input Atten**

### Internal Preamp State

```
[ :SENSe ] :POWer [ :RF ] :GAIN [ :STATe ] ON | OFF Mecha Atten
```

```
[ :SENSe ] :POWer [ :RF ] :GAIN :ATTenuation <integer>
```

Parameter Name: Internal Preamp

Factory Preset: OFF

State Saved: Saved in instrument state.

Range: ON | OFF

Remote Command Notes: This SCPI command setting is available in EDGE EVM measurement or GSM PFER measurement.

Example: :SENSe:POW:RF:GAIN on

Name: Mecha Atten

Factory Preset: 0

State Saved: Saved in instrument state.

Range: 0 to 20

SCPI Resolution: 10

Remote Command      This SCPI command setting is only available in  
Notes:                    EDGE EVM measurement or GSM PFER  
                                 measurement.

Example:                    :SENSe:POW:RF:GAIN on

### RF Port Power Range Auto

**[ :SENSe ] :POWER [ :RF ] :RANGe:AUTO OFF | ON | 0 | 1**

**[ :SENSe ] :POWER [ :RF ] :RANGe:AUTO?**

Select the RF port power range to be set either automatically or manually.

ON - power range is automatically set as determined by the actual measured power level at the start of a measurement.

OFF - power range is manually set

Factory Preset: ON

Remarks:                You must be in the cdmaOne, GSM, EDGE, NADC, PDC, cdma2000, W-CDMA, iDEN, or WiDEN mode to use this command. Use INSTRument:SELEct to set the mode.

Front Panel

Access:                    **Input, Max Total Pwr (at UUT)**

### RF Port Power Range Maximum Total Power

**[ :SENSe ] :POWER [ :RF ] :RANGe [ :UPPer ] <power>**

**[ :SENSe ] :POWER [ :RF ] :RANGe [ :UPPer ] ?**

Set the maximum expected total power level at the radio unit under test. This value is ignored if RF port power range is set to auto. External attenuation required above 30 dBm.

Factory Preset: -15.0 dBm

Range:                    -100.0 to 80.0 dBm for EDGE, GSM  
                                 -100.0 to 27.7 dBm for cdmaOne, iDEN (E4406A)  
                                 -200.0 to 50.0 dBm for NADC, PDC  
                                 -200.0 to 100.0 dBm for cdma2000, W-CDMA

Default Unit: dBm

Remarks:                Global to the current mode. This is coupled to the RF input attenuation

Programming Commands  
**SENSe Subsystem**

For E4406A you must be in the Service, cdmaOne, EDGE(w/GSM), GSM, iDEN, NADC, PDC, cdma2000, or W-CDMA mode to use this command. Use INSTRument:SElect to set the mode.

For PSA you must be in the cdmaOne, GSM, EDGE, NADC, PDC, cdma2000, or W-CDMA mode to use this command. Use INSTRument:SElect to set the mode.

Front Panel

Access:

**Input, Max Total Pwr (at UUT)**

## GMSK Power vs. Time Measurement

Commands for querying the power versus time measurement results and for setting to the default values are found in the “MEASure Group of Commands” on page 519. The equivalent front panel keys for the parameters described in the following commands, are found under the **Meas Setup** key, after the **GMSK Pwr vs Time** measurement has been selected from the **MEASURE** key menu.

### Power vs. Time—Number of Bursts Averaged

**[ :SENSe ] :PVTIme:AVERAge:COUNT <integer>**

**[ :SENSe ] :PVTIme:AVERAge:COUNT?**

Set the number of bursts that will be averaged. After the specified number of bursts (average counts), the averaging mode (termination control) setting determines the averaging action.

Factory Preset: 15

16 for iDEN, WiDEN

100 for 1xEV-DO

Range: 1 to 10,000

Remarks: For E4406A you must be in the EDGE(w/GSM), GSM, 1xEV-DO, W-CDMA, iDEN, WiDEN, or Service mode to use this command. Use INSTRument:SElect to set the mode.

For PSA you must be in the GSM, EDGE, 1xEV-DO or W-CDMA mode to use this command. Use INSTRument:SElect to set the mode.

### Power vs. Time—Averaging State

**[ :SENSe ] :PVTIme:AVERAge [ :STATe ] OFF | ON | 0 | 1**

**[ :SENSe ] :PVTIme:AVERAge [ :STATe ] ?**

Turn averaging on or off.

Factory Preset: OFF

ON for 1xEV-DO, W-CDMA

Remarks: For E4406A you must be in the EDGE(w/GSM), GSM, 1xEV-DO, W-CDMA, or Service mode to use this command. Use INSTRument:SElect to set the mode.

For PSA you must be in the GSM, EDGE, 1xEV-DO or W-CDMA mode to use this command. Use

INSTRument:SElect to set the mode.

### Power vs. Time—Averaging Termination Control

**[[:SENSe]:PVTTime:AVERAge:TCONtrol EXPonential|REPeat**

**[[:SENSe]:PVTTime:AVERAge:TCONtrol?**

Select the type of termination control used for the averaging function. This specifies the averaging action after the specified number of bursts (average count) is reached.

EXPonential - After the average count has been reached, each successive data acquisition is exponentially weighted and combined with the existing average.

REPeat - After reaching the average count, the averaging is reset and a new average is started.

Factory Preset: EXPonential

REPeat for 1xEV-DO, W-CDMA

Remarks: For E4406A you must be in the EDGE(w/GSM), GSM, 1xEV-DO, W-CDMA, or Service mode to use this command. Use INSTRument:SElect to set the mode.

For PSA you must be in the GSM, EDGE, 1xEV-DO or W-CDMA mode to use this command. Use INSTRument:SElect to set the mode.

### Power vs. Time—Averaging Type

*EDGE (w/GSM), GSM, Service GSM, EDGE mode*

**[[:SENSe]:PVTTime:AVERAge:TYPE  
LOG|MAXimum|MINimum|MXMinimum|RMS**

*iDEN, WiDEN mode*

**[[:SENSe]:PVTTime:AVERAge:TYPE  
LOG|MAXimum|MINimum|MXMinimum|RMS|POWer**

*1xEV-DO mode*

**[[:SENSe]:PVTTime:AVERAge:TYPE LOG|MAXimum|MINimum|RMS|SCALAr**

*W-CDMA mode*

**[[:SENSe]:PVTTime:AVERAge:TYPE RMS|MAXimum|MINimum**

**[[:SENSe]:PVTTime:AVERAge:TYPE?**

Select the type of averaging to be performed.



LOG - The log of the power is averaged. (This is also known as video averaging.)

MAXimum - The maximum values are retained.

MINimum - The minimum values are retained.

MXMinimum - Both the maximum and the minimum values are retained. (E4406A - EDGE(W/GSM), GSM, and Service modes, and PSA - GSM, EDGE, and 1xEV-DO modes only)

RMS - The power is averaged to provide a voltage rms value.

SCALar - The amplitude level of power is averaged to provide a voltage value. (1xEV-DO mode only)

POWER - averages the linear power of successive measurements.

Factory Preset: RMS

Remarks: For E4406A you must be in the EDGE(w/GSM), GSM, 1xEV-DO, W-CDMA, iDEN, WiDEN or Service mode to use this command. Use INSTRUMENT:SELEct to set the mode.

For PSA you must be in the GSM, EDGE, 1xEV-DO, or W-CDMA mode to use this command. Use INSTRUMENT:SELEct to set the mode.

### Power vs. Time—Resolution BW

**[ :SENSe ] :PVTtime :BANDwidth | BWIDth [ :RESolution ] <freq>**

**[ :SENSe ] :PVTtime :BANDwidth | BWIDth [ :RESolution ] ?**

Enables you to set the resolution bandwidth. This is an advanced control that normally does not need to be changed. Setting this to a value other than the factory default, may cause invalid measurement results.

Factory Preset: 500 kHz 1.5 MHz

5.0 MHz for W-CDMA

30 kHz for iDEN

120 kHz for WiDEN

Range: 1 kHz to 5 MHz

1.0 kHz to 10.0 MHz when PVT:BAND:RES:TYPE is set to FLATtop

1.0 kHz to 8.0 MHz when PVT:BAND:RES:TYPE is set to GAUSSian

Default Unit: Hz

Remarks: For E4406A you must be in the EDGE(w/GSM), GSM, Service, 1xEV-DO, iDEN, WiDEN, or W-CDMA mode to use this command. Use INSTRUMENT:SElect to set the mode.

For PSA you must be in the GSM, EDGE, 1xEV-DO, or W-CDMA mode to use this command. Use INSTRUMENT:SElect to set the mode.

Front Panel

Access: **Meas Setup, Advanced, Res BW**

### Power vs. Time—RBW Filter Type

```
[ :SENSe ] :PVTime :BANDwidth | BWIDth [ :RESolution ] :TYPE  
FLATtop | GAUSSian
```

```
[ :SENSe ] :PVTime :BANDwidth | BWIDth [ :RESolution ] :TYPE?
```

Enables you to select the type of resolution bandwidth filter. This is an advanced control that normally does not need to be changed. Setting this to a value other than the factory default, may cause invalid measurement results.

FLATtop - a filter with a flat amplitude response, which provides the best amplitude accuracy.

GAUSSian - a filter with Gaussian characteristics, which provides the best pulse response.

Factory Preset: GAUSSian

FLATtop for 1xEV-DO, W-CDMA, WiDEN

Remarks: For E4406A you must be in the EDGE(w/GSM), GSM, Service, 1xEV-DO, iDEN, WiDEN, or W-CDMA mode to use this command. Use INSTRUMENT:SElect to set the mode.

For PSA you must be in the GSM, EDGE, 1xEV-DO, or W-CDMA mode to use this command. Use INSTRUMENT:SElect to set the mode.

Front Panel Access: **Meas Setup, Advanced (WiDEN).**

### GMSK P<sub>v</sub>T Timeslot Length

```
[ :SENSe ] :PVTime :BSYNc :SLENgth EVEN | INTeger
```

```
[ :SENSe ] :PVTime :BSYNc :SLENgth?
```

Name:	GMSK P <sub>v</sub> T Timeslot Length
Key Path:	<b>Meas Setup, More, Advanced</b>
Factory Preset:	INTeger
State Saved:	Saved in instrument state.
Range:	All 156.25 symb   157/156 symb
Dependencies and Couplings:	This parameter is available only if the Burst Sync type is None.
Example:	:SENSe:PVTTime:BSYNc:SLENgth INTeger

### GMSK P<sub>v</sub>T Burst Synchronization Source

**[ :SENSe ] :PVTTime:BSYNc:SOURce TSEquence | RFBurst | NONE**  
**[ :SENSe ] :PVTTime:BSYNc:SOURce?**

This parameter specifies how the measurement algorithm synchronizes the reference time with the given signal.

KEY Training Seq SCPI TSEquence	The measurement algorithm first searches bursts and then searches training sequence (midamble) of each burst to determine the reference time for the limit mask. The reference time is adjusted slot-by-slot.
KEY RF Amptd SCPI RFBurst	The measurement algorithm calculates the burst width and determines the reference time for the limit mask so that the t <sub>0</sub> comes to the center of each burst. The reference time is adjusted slot-by-slot.
KEY None (Trigger Delay) SCPI NONE	The measurement algorithm does not search bursts at all. The timing to capture data is determined by user-defined Trigger Delay.

Name:	GMSK P <sub>v</sub> T Burst Synchronization Source
Key Path:	<b>Meas Setup</b>
Factory Preset:	TSEquence
State Saved:	Saved in instrument state.

Range:	Training Seq   RF Amptd   None (Trigger Delay)
Notes:	None choice is always available. However, the choice is meaningful only if the Trig Source is Ext Front or Ext Rear.
Example:	:SENSe:PVTime:BSYNc:SOURce TSEquence

### Power vs. Time—Limit Mask Display

```
[ :SENSe ] :PVTime:LIMit:MASK OFF|ON|0|1
```

```
[ :SENSe ] :PVTime:LIMit:MASK?
```

Show or hide the limit mask. Does not affect the pass/fail calculation for limit tests.

Factory Preset: ON

Remarks: You must be in GSM, EDGE, 1xEV-DO, or W-CDMA mode to use this command. Use INSTRument:SElect to set the mode.

### Power vs. Time—Lower Mask Absolute Amplitude Levels

```
[ :SENSe ] :PVTime:MASK:LIST:LOWer:ABSolute  
<power>, <power>, <power>, <power>, <power>, . . .
```

```
[ :SENSe ] :PVTime:MASK:LIST:LOWer:ABSolute?
```

Enter a power level for any of your mask line segments that require an absolute minimum power limit in addition to its relative limit. Each time a measurement is made the Ref Level is determined. (This is the power level of the useful part of the burst, or midway between the upper/lower masks). Remember, as the power of the Ref Level changes, all of the relative mask power levels will change by the same amount.

Each relative limit is then compared to the Ref Level and an equivalent absolute power level is calculated. This power level is compared to the specified absolute limit for each line segment. If this calculated relative limit is lower than the absolute limit you've specified, then the value of the absolute limit is used for this segment. Therefore, if the absolute limit is set to a very low value (–200 dBm), the calculated value of the reference limit will never be lower, and the specified relative limit will always be used for that segment. See [Figure 2 on page 456](#).

Every time point you defined with PVT:MASK:LOW:TIME must have a power value defined in the same order. You can put a comma in the SCPI command as a place holder for any points where an absolute power is not specified, and that segment will then use the default value.

Factory Preset: Selected GSM standard  
 Range: -200 dBm to +100 dBm  
 Default Unit: dBm  
 Remarks: You must be in GSM, EDGE, iDEN, or WiDEN mode to use this command. Use INSTRUMENT:SELEct to set the mode.  
 History: E4406A: Added in revised A.03.00 and later

### Power vs. Time—Lower Mask Points

**[ :SENSe ] :PVTIME:MASK:LIST:LOWer:POINTs?**

Query the number of elements in the lower mask. This value is determined by the number of time points entered using

**[ :SENSe ] :PVTIME:MASK:LIST:LOWer:TIME.**

Range: Integer, 1 to 25  
 Remarks: You must be in GSM, EDGE, iDEN, or WiDEN mode to use this command. Use INSTRUMENT:SELEct to set the mode.  
 History: E4406A: Added in revision A.03.00

### Power vs. Time—Lower Mask Relative Amplitude Levels

**[ :SENSe ] :PVTIME:MASK:LIST:LOWer:RELative**  
**<rel\_power>, <rel\_power>, <rel\_power>, <rel\_power>, <rel\_power>**  
**, ...**

**[ :SENSe ] :PVTIME:MASK:LIST:LOWer:RELative?**

Enter the relative power level for each horizontal line segment in the lower limit mask. There should be a power level for each time point entered using **[ :SENSe ] :PVTIME:MASK:LIST:LOWer:TIME**, and they must be entered in the same order. These power levels are all relative to the defined Reference Power Level (the average power in the useful part of the data). When an upper and lower limit masks have been defined, the Reference Power Level is the mid-point between these two limits at time  $t_0$ .

Any portion of the signal that has no limit line segment defined for it, will default to a very low limit (-100 dB relative to the reference power). This will keep the measurement from indicating a failure for that portion of the data.

Factory Preset: Selected standard  
 -100.0, -100.0, -2.5, -100.0, and -100.0 dB for

1xEV-DO  
-100.0, -100.0, -1.0, -100.0, and -100.0 dB for W-CDMA

Range: -100 to 200 dB relative to the reference power

Default Unit: dB

Remarks: You must be in GSM, EDGE, 1xEV-DO, iDEN, WiDEN, or W-CDMA mode to use this command. Use INSTRument:SElect to set the mode.

History: E4406A: Added in revision A.03.00

### Power vs. Time—Lower Mask Time Points

```
[ :SENSe ] :PVTIme:MASK:LIST:LOWer:TIME <seconds>{ , <seconds> }  
[ :SENSe ] :PVTIme:MASK:LIST:LOWer:TIME?
```

Enter the time points that define the horizontal line segments of the lower limit. A reference point designated “ $t_0$ ” is at the center of the useful data (usually the center of the burst). Each line segment to the right of the  $t_0$  reference point is designated as a positive time value and each segment to the left of  $t_0$  is a negative time value.

First enter positive values in sequence starting from  $t_0$ , then negative values in sequence starting from  $t_0$ . See [Figure 2 on page 456](#) and the PVT:MASK:LIST:UPPer:TIME example below it. (This is an upper mask example, but they work the same.)

We recommend that you select a large time value for your first and last mask points (e.g. -1 and +1 second). This guarantees that you’ve defined a limit for all the measured data. (See Mask Segments 4 and 9 in the [Table on page 457](#) for an example.)

Factory Preset: Selected standard

Range: -1s to +1s, referenced to  $t_0$  at the center of the useful data (burst center)  
1 to 25 time points in a mask

Default Unit: seconds

Remarks: You must be in GSM, EDGE, iDEN, WiDEN mode to use this command. Use INSTRument:SElect to set the mode.

History: E4406A: Added in revision A.03.00

## Power vs. Time—Upper Mask Absolute Amplitude Levels

```
[ :SENSe] :PVTTime:MASK:LIST:UPPer:ABSolute
<power>, <power>, <power>, <power>, <power>, ...
```

```
[ :SENSe] :PVTTime:MASK:LIST:UPPer:ABSolute?
```

Enter a power level for any of your mask line segments that require an absolute minimum power limit in addition to its relative limit. Each time a measurement is made the Ref Level is determined. (This is the power level of the useful part of the burst, or midway between the upper/lower masks). Remember, as the power of the Ref Level changes, all of the relative mask power levels will change by the same amount.

Each relative limit is then compared to the Ref Level and an equivalent absolute power level is calculated. This power level is compared to the specified absolute limit for each line segment. If this calculated relative limit is lower than the absolute limit you've specified, then the value of the absolute limit is used for this segment. Therefore, if the absolute limit is set to a very low value (–200 dBm), the calculated value of the reference limit will never be lower, and the specified relative limit will always be used for that segment. See [Figure 2 on page 456](#).

Every time point you defined with PVT:MASK:LOW:TIME must have a power value defined in the same order. You can put a comma in the SCPI command as a place holder for any points where an absolute power is not specified, and that segment will then use the default value.

```
Example:      PVT:MASK:LIST:UPP:ABS
              -200, -200, -58, -200, -200, -200, -200, -58, -200
```

Factory Preset: Selected standard

Range: –200 dBm to +100 dBm

Default Unit: dBm

Remarks: You must be in GSM, EDGE, iDEN, WiDEN mode to use this command. Use INSTRument:SElect to set the mode.

History: E4406A: Added in revision A.03.00

## Power vs. Time—Upper Mask Points

```
[ :SENSe] :PVTTime:MASK:LIST:UPPer:POINTs?
```

Query the number of elements in the upper mask. This value is determined by the number of time points entered using

```
[ :SENSe] :PVTTime:MASK:LIST:UPPer:TIME.
```

Range: integer, 1 to 25

Remarks: You must be in GSM, EDGE, iDEN, WiDEN mode to

use this command. Use INSTRument:SElect to set the mode.

History: E4406A: Added in revision A.03.00

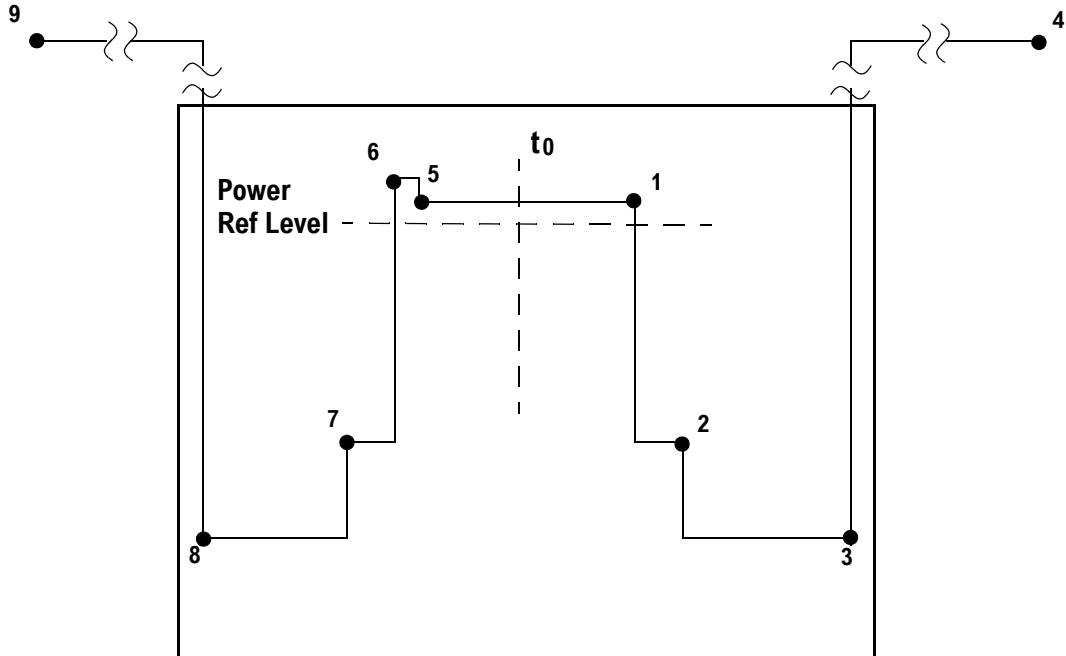
### Power vs. Time—Upper Mask Relative Amplitude Levels

```
[ :SENSe ] :PVTime:MASK:LIST:UPPer:RELative <rel_power>,  
<rel_power>,<rel_power>,<rel_power>,...
```

```
[ :SENSe ] :PVTime:MASK:LIST:UPPer:RELative?
```

Enter the relative power level for each horizontal line segment in the upper limit mask. There should be a power level for each time point entered using [ :SENSe ] :PVTime:MASK:LIST:UPPer:TIME, and they must be entered in the same order. These power levels are all relative to the defined Reference Power Level (the average power in the useful part of the data). When an upper and lower limit masks have been defined, the Reference Power Level is the mid-point between these two limits at time  $t_0$ . See [Figure 2 on page 456](#).

**Figure 2** Custom Upper Limit Mask Example





Entered Value for each Time Segment	Absolute Time Value	Relative Power (example with Ref Level = -12 dBm)		Entered Absolute Power (dBm)	Segment Number
		Entered Relative Power	Equivalent Absolute Power		
280.0e-6	280 $\mu$ s	+4 dBc	-8 dBm	-200 dBm	1
15.0e-6	295 $\mu$ s	-32 dBc	-44 dBm	-200 dBm	2
450.0e-6	745 $\mu$ s	-48 dBc	-60 dBm <sup>a</sup>	-58 dBm <sup>a</sup>	3
1	>1 sec	+100 dBc	+88 dBm	-200 dBm	4
-270.0e-6	-270 $\mu$ s	+4 dBc	-8 dBm	-200 dBm	5
-10.0e-6	-280 $\mu$ s	+7 dBc	-5 dBm	-200 dBm	6
-20.0e-6	-300 $\mu$ s	-25 dBc	-37 dBm	-200 dBm	7
-450e-6	-750 $\mu$ s	-43 dBc	-55 dBm	-58 dBm	8
-1	<-1 sec	+100 dBc	+88 dBm	-200 dBm	9

a. Notice that this segment, with this value of Ref Level, has a calculated relative level of -60 dBm. This is lower than the specified absolute level of -58 dBm, so the -58 dBm value will be used as the test limit for the segment.

Example: **PVT:MASK:LIST:UPP:REL**  
**4, -32, -48, 100, 4, 7, -25, -43, 100**

Factory Preset: Selected standard  
-7.0, 2.5, 2.5, 2.5, and 7.5 dB for 1xEV-DO  
-40.0 dB, 2.0 dB, 1.0 dB, 2.0 dB, -40.0 dB for W-CDMA

Range: -100 to +200 dB relative to the reference power

Default Unit: dB

Remarks: You must be in GSM, EDGE, 1xEV-DO, iDEN, WiDEN or W-CDMA mode to use this command. Use INSTRUMENT:SELEct to set the mode.

History: E4406A: Added in revision A.03.00

### Power vs. Time—Upper Mask Time Points

**[ :SENSE ] :PVTtime:MASK:LIST:UPPER:TIME**  
**<seconds>, <seconds>, <seconds>, <seconds>, <seconds>, ...**

**[ :SENSE ] :PVTtime:MASK:LIST:UPPER:TIME?**

Enter the time points that define the horizontal line segments of the upper limit. A reference point designated “ $t_0$ ” is at the center of the useful data (usually the center of the burst). Each line segment to the right of the  $t_0$  reference point is designated as a positive time value and each segment to the left of  $t_0$  is a negative time value.

First enter positive values in sequence starting from  $t_0$ , then the negative values in sequence starting from  $t_0$ . See [Figure 2 on page 456](#) and the `PVTime:MASK:LIST:UPPER:TIME` example below it.

We recommend that you select a large time value for your first and last mask points (e.g. -1 and +1 second). This guarantees that you’ve defined a limit for all the measured data. (See Mask Segments 4 and 9 in the table [Table on page 457](#) for an example.

Example: `PVTime:MASK:LIST:UPPER:TIME`  
`280e-6,15e-6,450e-6,1,-270e-6,-10e-6,-20e-6,-`  
`450-6,-1`

Factory Preset: Selected standard

Range: -1s to +1s, referenced to  $t_0$  at the center of the useful data (burst center)

1 to 25 time points in a mask

Default Unit: seconds

Remarks: You must be in GSM, EDGE, iDEN, WiDEN mode to use this command. Use `INSTRUMENT:SElect` to set the mode.

History: E4406A: Added in revision A.03.00

### Power vs. Time—Custom Limit Masks

`[[:SENSe]:PVTime:MASK:SElect STANDARD|CUSTOM`

`[[:SENSe]:PVTime:MASK:SElect?`

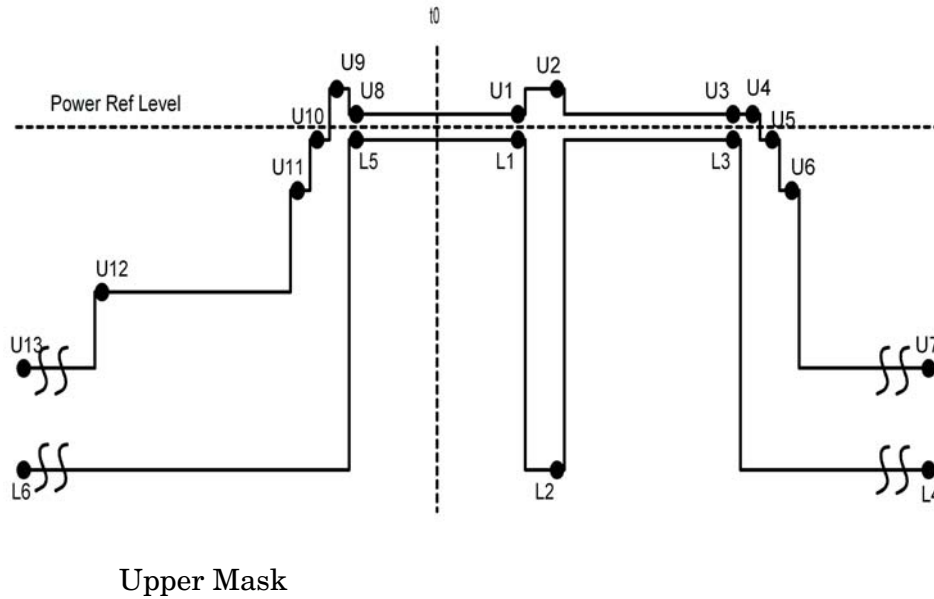
Select standard masks or user-defined custom masks to compare you measured data against. See [“GMSK PvT Custom Limit Mask Example of Two Consecutive Bursts” on page 459](#).

Factory Preset: STANDARD

Remarks: You must be in GSM, EDGE, iDEN, WiDEN mode to use this command. Use `INSTRUMENT:SElect` to set the mode.

### GMSK PVT Custom Limit Mask Example of Two Consecutive Bursts

**Figure 4-5** GMSK PVT Custom Limit Mask Example of Two Consecutive Bursts



Segment Number	Timing	Relative Limit Level	Absolute Limit Level
U1	271.384615e-6	1.0	-200.0
U2	33.23e-6	4.0	-200.0
U3	542.76923e-6	1.0	-200.0
U4	10.0e-6	1.0	-200.0
U5	8.0e-6	-6.0	-200.0
U6	10.0e-6	-30.0	-17.0
U7	1.0 (large enough)	-59.0	-54.0
U8	-271.384615e-6	1.0	-200.0
U9	-10.0e-6	4.0	-200.0
U10	-8.0e-6	-6.0	-200.0
U11	-10.0e-6	-30.0	-17.0
U12	-576.0e-6	-59.0	-36.0
U13	-1.0 (large enough)	-59.0	-54.0

## Lower Mask

Segment Number	Timing	Relative Limit Level	Absolute Limit Level
L1	271.384615e-6	-1.0	-200.0
L2	33.23e-6	-200.0	-200.0
L3	542.76923e-6	-1.0	-200.0
L4	1.0 (large enough)	-200.0	-200.0
L5	-271.384615e-6	-1.0	-200.0
L6	-1.0 (large enough)	-200.0	-200.0

*Sample SCPI Sequence to Define The Above Mask*

```

:SENSe:PVTime:MASK:SElect CUST
:SENSe:PVTime:SWEEP:TIME 3
:SENSe:PVTime:MASK:LIST:UPPer:TIME
271.384615e-6, 33.23e-6, 542.76923e-6, 10.0e-6, 8.0e-6, 10.0e-6, 1.0,
-271.384615e-6, -10.0e-6, -8.0e-6, -10.0e-6, -576.0e-6, -1.0
:SENSe:PVTime:MASK:LIST:UPPer:RELative
1.0, 4.0, 1.0, 1.0, -6.0, -30.0, -59.0,
1.0, 4.0, -6.0, -30.0, -59.0, -59.0
:SENSe:PVTime:MASK:LIST:UPPer:ABSolute
-200.0, -200.0, -200.0, -200.0, -200.0, -17.0, -54.0,
-200.0, -200.0, -200.0, -17.0, -36.0, -54.0
:SENSe:PVTime:MASK:LIST:LOWer:TIME
271.384615e-6, 33.23e-6, 542.76923e-6, 1.0, -271.384615e-6, -1.0
:SENSe:PVTime:MASK:LIST:LOWer:RELative
-1.0, -200.0, -1.0, -200.0, -1.0, -200.0
:SENSe:PVTime:MASK:LIST:LOWer:ABSolute
-200.0, -200.0, -200.0, -200.0, -200.0, -200.0

```

### Power vs Time—Select Power Control Level

Allows user to indicate the output power of the transmitter; in MS testing transmitter output power level will affect the mask. The appropriate power level for measuring the device under test will correspond with the transmitter power control level setting.

```
[ :SENSe ] :PVTime:PCLevel <integer>
```

```
[ :SENSe ] :PVTime:PCLevel?
```

Range: 0 to 40

Remarks: You must be in the power vs. time measurement in GSM, EDGE mode to use this command. Use INSTRument:SElect to set the mode

Front Panel Access: **Meas Setup, More (1 of 2), Pwr Cntrl Lvl.**

History: E4406A: Added in version A.05.00

### Power vs. Time—Sweep Time

**[ :SENSe ] :PVTIme :SWEep :TIME <integer>**

**[ :SENSe ] :PVTIme :SWEep :TIME?**

Set the number of slots which are used in each data acquisition. Each slot is approximately equal to 570  $\mu$ s. The measurement is made for a small additional amount of time (about 130  $\mu$ s) in order to view the burst edges.

Factory Preset: 1

Range: 1 to 8 (for resolution BW = 500 kHz)

Remarks: For E4406A you must be in the EDGE(w/GSM), GSM or Service mode to use this command. Use INSTRument:SElect to set the mode.

For PSA you must be in the GSM, EDGE mode to use this command. Use INSTRument:SElect to set the mode.

### Power vs. Time—Trigger Source

**[ :SENSe ] :PVTIme :TRIGger :SOURce EXTErnal [1] | EXTErnal2 | FRAME | IF | IMMEDIATE | RFBURst**

**[ :SENSe ] :PVTIme :TRIGger :SOURce?**

Select the trigger source used to control the data acquisitions.

EXTErnal 1 - front panel external trigger input

EXTErnal 2 - rear panel external trigger input

FRAME - uses the internal frame timer, which has been synchronized to the selected burst sync.

IF - internal IF envelope (video) trigger

LINE - internal power line frequency trigger

IMMEDIATE - the next data acquisition is immediately taken, capturing the signal asynchronously (also called Free Run).

RFBURst - wideband RF burst envelope trigger that has automatic

level control for periodic burst signals.

Factory Preset: RFBurst if the RF Communications Hardware (option B7E) has been installed

EXTernal, if option B7E has not been installed

FRAMe for 1xEV-DO

IF envelope (video) (iDEN, WiDEN)

Remarks: You must be in GSM, EDGE, Service, 1xEV-DO, iDen, WiDEN, or W-CDMA mode to use this command. Use INSTRUMENT:SElect to set the mode.

## Radio Standards Commands

### Radio Carrier Hopping

**[ :SENSe ] :RADio:CARRier:HOP OFF | ON | 0 | 1**

**[ :SENSe ] :RADio:CARRier:HOP?**

Turns the carrier hopping mode on and off.

Factory Preset: OFF

Remarks: Global to the current mode.

You must be in the GSM, EDGE mode to use this command. Use INSTRument:SElect to set the mode.

History: E4406A: Version A.03.00 or later

Front Panel

Access: **Mode Setup, Radio, Carrier**

### Radio Carrier Multiple

**[ :SENSe ] :RADio:CARRier:NUMBER SINGLE | MULTiple**

**[ :SENSe ] :RADio:CARRier:NUMBER?**

Select if single or multiple carriers are present on the output of the base station under test. This enables/disables a software filter for the rho and code domain power measurements.

SINGLE – disable software filter.

MULTiple – enable software filter to mitigate the adjacent carrier effects.

Factory Preset: SINGLE

Remarks: You must be in the GSM or EDGE, cdmaOne, cdma2000, 1xEV-DO, or iDEN (E4406A) mode to use this command. Use INSTRument:SElect to set the mode.

For GSM/EDGE, this SCPI command setting is available for use with the EDGE EVM measurement or GSM PFER measurement only. Other measurements in the GSM/EDGE personality don't support this feature.

Front Panel

Access: **Mode Setup, Demod, RF Carrier**

## Radio Carrier Burst

```
[ :SENSe ] :RADio:CARRier [ :TYPE ] BURSt | CONTInuous  
[ :SENSe ] :RADio:CARRier [ :TYPE ] ?
```

Select the type of RF carrier on the device to be tested.

Factory Preset: BURSt

Remarks: You must be in the GSM, EDGE mode to use this command. Use INSTRument:SELEct to set the mode.

Global to the current mode.

History: E4406A: Version A.03.00 or later

Front Panel

Access: **Mode Setup, Radio, Carrier**

## Radio Device Under Test

```
[ :SENSe ] :RADio:DEVice BTS | MS  
[ :SENSe ] :RADio:DEVice ?
```

Select the type of radio device to be tested.

BTS - Base station transmitter test

MS - Mobile station transmitter test

Factory Preset: BTS

Remarks: Global to the current mode.

You must be in cdma2000, GSM, EDGE, W-CDMA or 1xEV-DO mode to use this command. Use INSTRument:SELEct to set the mode.

History: E4406A:  
Version A.03.00 or later

Front Panel

Access: **Mode Setup, Radio, Device**

## BTS Type

```
[ :SENSe ] :RADio:DEVice:BASE [ :TYPE ]  
NORMal | MICRo | MICR1 | MICR2 | MICR3 | PICO  
[ :SENSe ] :RADio:DEVice:BASE [ :TYPE ] ?
```

This parameter is common to all measurements in GSM/EDGE personality.



KEY Normal	Normal BTS
SCPI NORMAl	
KEY Micro1	Micro 1 BTS
SCPI MICR1   MICRo	Note: SCPI enumeration 'MICRo' is kept for backward compatibility. It is equivalent to 'MICR1'.
KEY Micro2	Micro 2 BTS
SCPI MICR2	
KEY Micro3	Micro 3 BTS
SCPI MICR3	
KEY Pico	Pico BTS
SCPI PICO	

Name:	BTS Type
Key Path:	<b>Mode Setup, 1</b>
Default:	NORMAl
State Saved:	Saved in instrument state.
Range:	Normal   Micro1   Micro2   Micro3   Pico
Example:	:SENSe:RADio:DEVIce:BASE:TYPE NORMAl

## Radio Standard Band

```
[ :SENSe ] :RADio:STANdard:BANd
PGSM | EGSM | RGSM | DCS1800 | PCS1900 | GSM450 | GSM480 | GSM700 | GSM850
[ :SENSe ] :RADio:STANdard:BANd?
```

Select the standard variant that applies to the radio to be tested.

PGSM - Primary GSM in the 900 MHz band

EGSM - Extended GSM in the 900 MHz band

RGSM - Railway GSM in the 900 MHz band

DCS1800 - DSC1800 band; also known as GSM-1800

PCS1900 - PCS1900 band; also known as GSM-1900

GSM450 - GSM450 band

GSM480 - GSM480 band

GSM700 - GSM700band

GSM850 - GSM850 band, for IS-136HS

Factory Preset: PGSM for GSM

EGSM-900 for EDGE

Remarks: Global to the current mode.

You must be in GSM, EDGE mode to use this command.  
Use INSTRument:SElect to set the mode.

History: E4406A: More standards added A.02.00, A.03.00

Front Panel

Access: **Mode Setup, Radio, Band**



## Reference Oscillator Commands

### Reference Oscillator External Frequency

**[[:SENSe]:ROSCillator:EXTeRnal:FREQuency <frequency>**

**[[:SENSe]:ROSCillator:EXTeRnal:FREQuency?**

Specify to the frequency of the external reference being supplied to the instrument. Switch to the external reference with ROSC:SOUR.

Preset  
and \*RST: Value remains at last user selected value (persistent)

Factory default, 10 MHz

Range: 1 MHz to 30 MHz, with 1 Hz steps

Default Unit: Hz

Remarks: Global to system

Front Panel

Access: **System, Reference, Ref Oscillator**

### Reference Oscillator Rear Panel Output

**[[:SENSe]:ROSCillator:OUTPut[:STaTe] OFF|ON|0|1**

**[[:SENSe]:ROSCillator:OUTPut?**

Turn on and off the 10 MHz frequency reference signal going to the rear panel.

Preset  
and \*RST: Persistent State with factory default of On

Remarks: Global to system. Was SENS:ROSC:REAR

Front Panel

Access: **System, Reference, 10 MHz Out**

### Reference Oscillator Source

**[[:SENSe]:ROSCillator:SOURce INTernal|EXTeRnal**

**[[:SENSe]:ROSCillator:SOURce?**

Select the reference oscillator (time base) source. Use ROSC:EXT:FREQ to tell the instrument the frequency of the external reference.

INTernal - uses internally generated 10 MHz reference signal

EXTeRnal - uses the signal at the rear panel external reference input port.

Preset  
and \*RST: Persistent State with factory default of Internal

Remarks: Global to system.

Front Panel  
Access: **System, Reference, Ref Oscillator**



## Spectrum (Frequency-Domain) Measurement

Commands for querying the spectrum measurement results and for setting to the default values are found in the “[MEASure Group of Commands](#)” on page 519. The equivalent front panel keys for the parameters described in the following commands, are found under the **Meas Setup** key, after the **Spectrum (Freq Domain)** measurement has been selected from the **MEASURE** key menu.

### Spectrum—Data Acquisition Packing

```
[ :SENSE ] :SPECTrum:ACQuisition:PACKing
AUTO | LONG | MEDium | SHORt
```

```
[ :SENSE ] :SPECTrum:ACQuisition:PACKing?
```

Select the amount of data acquisition packing. This is an advanced control that normally does not need to be changed.

Factory Preset: AUTO

Remarks: To use this command for E4406A, the appropriate mode should be selected with INSTRUMENT:SElect.

For PSA you must be in the Basic, Analog Modulation, cdmaOne, cdma2000, 1xEV-DO, W-CDMA, GSM, EDGE, NADC, or PDC mode to use this command. Use INSTRUMENT:SElect to set the mode.

### Spectrum—ADC Dither Control

```
[ :SENSE ] :SPECTrum:ADC:DITHer [ :STATE ] AUTO | ON | OFF | 2 | 1 | 0
```

```
[ :SENSE ] :SPECTrum:ADC:DITHer [ :STATE ] ?
```

Turn the ADC dither on or off. This is an advanced control that normally does not need to be changed. The “ADC dither” refers to the introduction of noise to the digitized steps of the analog-to-digital converter; the result is an improvement in amplitude accuracy.

The Option 122 wideband ADC dither uses SENSE:SPECTrum:WBIF:ADC:DITHer.

Factory Preset: AUTO

Remarks: To use this command for E4406A, the appropriate mode should be selected with INSTRUMENT:SElect.

For PSA you must be in the Basic, Analog Modulation, cdmaOne, cdma2000, 1xEV-DO, W-CDMA, GSM, EDGE, NADC, or PDC mode to use this command. Use INSTRUMENT:SElect to set the mode.

## Spectrum—ADC Range

12-bit ADC E4406A

**[ :SENSe ] :SPECTrum:ADC:RANGe**

**AUTO | APEak | APLock | M6 | P0 | P6 | P12 | P18 | P24**

PSA and 14-bit ADC E4406A

**[ :SENSe ] :SPECTrum:ADC:RANGe**

**AUTO | APEak | APLock | NONE | P0 | P6 | P12 | P18**

**[ :SENSe ] :SPECTrum:ADC:RANGe?**

Select the range for the gain-ranging that is done in front of the ADC. This is an advanced control that normally does not need to be changed. Auto peak ranging is the default for this measurement. If you are measuring a CW signal please see the description below.

- AUTO - automatic range

For FFT spectrums - auto ranging should not be used. An exception to this would be if you know that your signal is “bursty”. Then you might use auto to maximize the time domain dynamic range as long as you are not very interested in the FFT data.

- Auto Peak (APEak) - automatically peak the range

For CW signals, the default of auto-peak ranging can be used, but a better FFT measurement of the signal can be made by selecting one of the manual ranges that are available: M6, P0 - P24.

Auto peaking can cause the ADC range gain to move monotonically down during the data capture. This movement should have negligible effect on the FFT spectrum, but selecting a manual range removes this possibility. Note that if the CW signal being measured is close to the auto-ranging threshold, the noise floor may shift as much as 6 dB from sweep to sweep.

- Auto Peak Lock (APLock) - automatically peak lock the range

For CW signals, auto-peak lock ranging may be used. It will find the best ADC measurement range for this particular signal and will not move the range as auto-peak can. Note that if the CW signal being measured is close to the auto-ranging threshold, the noise floor may shift as much as 6 dB from sweep to sweep.

For “bursty” signals, auto-peak lock ranging should not be used. The measurement will fail to operate, since the wrong (locked) ADC range will be chosen often and overloads will occur in the ADC.

- NONE - (PSA and 14-bit ADC E4406A) turns off any auto-ranging without making any changes to the current setting.
- M6 - (12-bit ADC E4406A) manually selects an ADC range that subtracts 6 dB of fixed gain across the range. Manual ranging is best



for CW signals.

- P0 to P18 - (PSA and 14-bit ADC E4406A) manually selects ADC ranges that add 0 to 18 dB of fixed gain across the range. Manual ranging is best for CW signals.
- P0 to 24 - (12-bit ADC E4406A) manually selects ADC ranges that add 0 to 24 dB of fixed gain across the range. Manual ranging is best for CW signals.

Factory Preset: APEak

Remarks: To use this command for E4406A, the appropriate mode should be selected with INSTRument:SElect.

For PSA you must be in the Basic, Analog Modulation, cdmaOne, cdma2000, 1xEV-DO, W-CDMA, GSM, EDGE, NADC, or PDC mode to use this command. Use INSTRument:SElect to set the mode.

### Spectrum—Average Clear

**[ :SENSe ] :SPECTrum:AVERAge:CLEar**

The average data is cleared and the average counter is reset.

Remarks: To use this command for E4406A, the appropriate mode should be selected with INSTRument:SElect.

For PSA you must be in the Basic, Analog Modulation, cdmaOne, cdma2000, 1xEV-DO, W-CDMA, GSM, EDGE, NADC, or PDC mode to use this command. Use INSTRument:SElect to set the mode.

### Spectrum—Number of Averages

**[ :SENSe ] :SPECTrum:AVERAge:COUNT <integer>**

**[ :SENSe ] :SPECTrum:AVERAge:COUNT?**

Set the number of ‘sweeps’ that will be averaged. After the specified number of ‘sweeps’ (average counts), the averaging mode (terminal control) setting determines the averaging action.

Factory Preset: 25

Range: 1 to 10,000

Remarks: To use this command for E4406A, the appropriate mode should be selected with INSTRument:SElect.

For PSA you must be in the Basic, Analog Modulation, cdmaOne, cdma2000, 1xEV-DO, W-CDMA, GSM,

EDGE, NADC, or PDC mode to use this command. Use INSTRUMENT:SElect to set the mode.

### Spectrum—Averaging State

**[ :SENSe ] :SPECTrum:AVERAge [ :STATe ] OFF | ON | 0 | 1**

**[ :SENSe ] :SPECTrum:AVERAge [ :STATe ] ?**

Turn averaging on or off.

Factory Preset: On

Remarks: To use this command for E4406A, the appropriate mode should be selected with INSTRUMENT:SElect.

For PSA you must be in the Basic, Analog Modulation, cdmaOne, cdma2000, 1xEV-DO, W-CDMA, GSM, EDGE, NADC, or PDC mode to use this command. Use INSTRUMENT:SElect to set the mode.

### Spectrum—Averaging Termination Control

**[ :SENSe ] :SPECTrum:AVERAge:TCONtrol EXPonential | REPeat**

**[ :SENSe ] :SPECTrum:AVERAge:TCONtrol ?**

Select the type of termination control used for the averaging function. This determines the averaging action after the specified number of 'sweeps' (average count) is reached.

EXPonential - Each successive data acquisition after the average count is reached, is exponentially weighted and combined with the existing average.

REPeat - After reaching the average count, the averaging is reset and a new average is started.

Factory Preset: EXPonential

Remarks: To use this command for E4406A, the appropriate mode should be selected with INSTRUMENT:SElect.

For PSA you must be in the Basic, Analog Modulation, cdmaOne, cdma2000, 1xEV-DO, W-CDMA, GSM, EDGE, NADC, or PDC mode to use this command. Use INSTRUMENT:SElect to set the mode.

### Spectrum—Averaging Type

**[ :SENSe ] :SPECTrum:AVERAge:TYPE**

**LOG | MAXimum | MINimum | RMS | SCALar**

**[ :SENSe ] :SPECTrum:AVERAge:TYPE?**

Select the type of averaging.

LOG – The log of the power is averaged. (This is also known as video averaging.)

MAXimum – The maximum values are retained.

MINimum – The minimum values are retained.

RMS – The power is averaged, providing the rms of the voltage.

SCALar – The voltage is averaged.

Factory Preset: LOG

Remarks: To use this command for E4406A, the appropriate mode should be selected with INSTRument:SElect.

For PSA you must be in the Basic, Analog Modulation, cdmaOne, cdma2000, 1xEV-DO, W-CDMA, GSM, EDGE, NADC, or PDC mode to use this command. Use INSTRument:SElect to set the mode.

### Spectrum—Select Pre-FFT Bandwidth

**[ :SENSe ] :SPECTrum:BANDwidth | BWIDth:IF:AUTO OFF | ON | 0 | 1**

**[ :SENSe ] :SPECTrum:BANDwidth | BWIDth:IF:AUTO?**

Select auto or manual control of the pre-FFT BW.

Factory Preset: Auto, 1.55 MHz

Auto, 10 MHz for wideband IF path  
(SENSe:SPECTrum:IFPath WIDE)

Couplings/

Dependencies: PSA: If you have the wideband Option 122 and the wideband IF path is selected, then the sample rate =  $1.25 \times$  IF bandwidth.

Remarks: To use this command for E4406A, the appropriate mode should be selected with INSTRument:SElect.

For PSA you must be in the Basic, Analog Modulation, cdmaOne, cdma2000, 1xEV-DO, W-CDMA, GSM, EDGE, NADC, or PDC mode to use this command. Use INSTRument:SElect to set the mode.

Front Panel

Access: **Measure, Spectrum, Meas Setup, More, Advanced, Pre-FFT BW.**

History: Modified in PSA revision A.06.00.

### Spectrum—IF Flatness Corrections

```
[ :SENSe ] :SPECTrum: BANDwidth | BWIDth: IF: FLATness OFF | ON | 0 | 1
```

```
[ :SENSe ] :SPECTrum: BANDwidth | BWIDth: IF: FLATness?
```

Turns IF flatness corrections on and off for the pre-FFT narrowband IF. The Option 122 wideband IF flatness control uses SENSE:SPECTrum:WBIF:FLATness.

Factory Preset: ON

Remarks: To use this command for E4406A, the appropriate mode should be selected with INSTRument:SElect.

For PSA you must be in the Basic, Analog Modulation, cdmaOne, cdma2000, 1xEV-DO, W-CDMA, GSM, EDGE, NADC, or PDC mode to use this command. Use INSTRument:SElect to set the mode.

Front Panel

Access: **Measure, Spectrum, Meas Setup, More, Advanced, Pre-FFT BW**

### Spectrum—Pre-ADC Bandpass Filter

```
[ :SENSe ] :SPECTrum: BANDwidth | BWIDth: PADC OFF | ON | 0 | 1
```

```
[ :SENSe ] :SPECTrum: BANDwidth | BWIDth: PADC?
```

Turn the pre-ADC bandpass filter on or off. This is an advanced control that normally does not need to be changed.

Remarks: To use this command for E4406A, the appropriate mode should be selected with INSTRument:SElect.

For PSA you must be in the Basic, Analog Modulation, cdmaOne, cdma2000, 1xEV-DO, W-CDMA, GSM, EDGE, NADC, or PDC mode to use this command. Use INSTRument:SElect to set the mode.

### Spectrum—Pre-FFT BW

```
[ :SENSe ] :SPECTrum: BANDwidth | BWIDth: PFFT [ :SIZE ] <freq>
```

```
[ :SENSe ] :SPECTrum: BANDwidth | BWIDth: PFFT [ :SIZE ] ?
```

Set the pre-FFT bandwidth. This is an advanced control that normally does not need to be changed.

Frequency span, resolution bandwidth, and the pre-FFT bandwidth settings are normally coupled. If you are not auto-coupled, there can be combinations of these settings that are not valid.

Factory Preset: 1.55 MHz

1.25 MHz for cdmaOne

155.0 kHz, for iDEN mode (E4406A)

Range: 1 Hz to 10.0 MHz

Remarks: To use this command for E4406A, the appropriate mode should be selected with INSTRUMENT:SElect.

For PSA you must be in the Basic, Analog Modulation, cdmaOne, cdma2000, 1xEV-DO, W-CDMA, GSM, EDGE, NADC, or PDC mode to use this command. Use INSTRUMENT:SElect to set the mode.

### Spectrum—Pre-FFT BW Filter Type

**[ :SENSE ] :SPECTrum: BANDwidth | BWIDth: PFFT: TYPE FLAT | GAUSSian**

**[ :SENSE ] :SPECTrum: BANDwidth | BWIDth: PFFT: TYPE ?**

Select the type of pre-FFT filter that is used. This is an advanced control that normally does not need to be changed.

Flat top (FLAT)- a filter with a flat amplitude response, which provides the best amplitude accuracy.

GAUSSian - a filter with Gaussian characteristics, which provides the best pulse response.

Factory Preset: FLAT

Couplings/

Dependencies: From the front panel this functionality is not available (key is greyed out), but this command will change the setting.

Remarks: To use this command for E4406A, the appropriate mode should be selected with INSTRUMENT:SElect.

For PSA you must be in the Basic, Analog Modulation, cdmaOne, cdma2000, 1xEV-DO, W-CDMA, GSM, EDGE, NADC, or PDC mode to use this command. Use INSTRUMENT:SElect to set the mode.

History: PSA: modified with revision A.06.00

### Spectrum—Resolution BW

```
[ :SENSe ] :SPECTrum: BANDwidth | BWIDth [ :RESolution ] <freq>
```

```
[ :SENSe ] :SPECTrum: BANDwidth | BWIDth [ :RESolution ] ?
```

Set the resolution bandwidth for the FFT. This is the bandwidth used for resolving the FFT measurement. It is not the pre-FFT bandwidth. This value is ignored if the function is auto-coupled.

Frequency span, resolution bandwidth, and the pre-FFT bandwidth settings are normally coupled. If you are not auto-coupled, there can be combinations of these settings that are not valid.

Factory Preset: 20.0 kHz

250.0 Hz, for iDEN mode (E4406A)

Range: 0.10 Hz to 3.0 MHz

Remarks: To use this command for E4406A, the appropriate mode should be selected with INSTRument:SElect.

For PSA you must be in the Basic, Analog Modulation, cdmaOne, cdma2000, 1xEV-DO, W-CDMA, GSM, EDGE, NADC, or PDC mode to use this command. Use INSTRument:SElect to set the mode.

### Spectrum—Resolution BW Auto

```
[ :SENSe ] :SPECTrum: BANDwidth | BWIDth [ :RESolution ] :AUTO  
OFF | ON | 0 | 1
```

```
[ :SENSe ] :SPECTrum: BANDwidth | BWIDth [ :RESolution ] :AUTO?
```

Select auto or manual control of the resolution BW. The automatic mode couples the resolution bandwidth setting to the frequency span.

Factory Preset: ON

OFF, for iDEN mode (E4406A)

Remarks: To use this command for E4406A, the appropriate mode should be selected with INSTRument:SElect.

For PSA you must be in the Basic, Analog Modulation, cdmaOne, cdma2000, W-CDMA, GSM, EDGE, NADC, or PDC mode to use this command. Use INSTRument:SElect to set the mode.

### Spectrum—Decimation of Spectrum Display

```
[ :SENSe ] :SPECTrum: DECimate [ :FACTor ] <integer>
```

**[ :SENSe ] :SPECTrum:DECimate [ :FACTor ] ?**

Sets the amount of data decimation done by the hardware and/or the software. Decimation by n keeps every nth sample, throwing away each of the remaining samples in the group of n. For example, decimation by 3 keeps every third sample, throwing away the two in between. Similarly, decimation by 5 keeps every fifth sample, throwing away the four in between.

Using zero (0) decimation selects the automatic mode. The measurement will then automatically choose decimation by “1” or “2” as is appropriate for the bandwidth being used.

This is an advanced control that normally does not need to be changed.

Factory Preset: 0

Range: 0 to 1,000, where 0 sets the function to automatic

Remarks: To use this command for E4406A, the appropriate mode should be selected with INSTRument:SElect.

For PSA you must be in the Basic, Analog Modulation, cdmaOne, cdma2000, 1xEV-DO, W-CDMA, GSM, EDGE, NADC, or PDC mode to use this command. Use INSTRument:SElect to set the mode.

History: E4406A:  
Version A.02.00 or later

**Spectrum—FFT Length**

**[ :SENSe ] :SPECTrum:FFT:LENGth <integer>**

**[ :SENSe ] :SPECTrum:FFT:LENGth?**

Set the FFT length. This value is only used if length control is set to manual. The value must be greater than or equal to the window length value. Any amount greater than the window length is implemented by zero-padding. This is an advanced control that normally does not need to be changed.

Factory Preset: 706

Range: min, depends on the current setting of the spectrum window length  
max, 1,048,576

Remarks: To use this command for E4406A, the appropriate mode should be selected with INSTRument:SElect.

For PSA you must be in the Basic, Analog Modulation, cdmaOne, cdma2000, 1xEV-DO, W-CDMA, GSM, EDGE, NADC, or PDC mode to use this command. Use

INSTRument:SElect to set the mode.

History: E4406A:  
Short form changed from LENgth to LENGth, A.03.00

### Spectrum—FFT Length Auto

**[ :SENSe ] :SPECTrum:FFT:LENGth:AUTO OFF | ON | 0 | 1**

**[ :SENSe ] :SPECTrum:FFT:LENGth:AUTO?**

Select auto or manual control of the FFT and window lengths.

This is an advanced control that normally does not need to be changed.

On - the window lengths are coupled to resolution bandwidth, window type (FFT), pre-FFT bandwidth (sample rate) and SENSE:SPECTrum:FFT:RBWPoints.

Off - lets you set SENSE:SPECTrum:FFT:LENGth and SENSE:SPECTrum:FFT:WINDow:LENGth.

Factory Preset: ON

Remarks: To use this command for E4406A, the appropriate mode should be selected with INSTRument:SElect.

For PSA you must be in the Basic, Analog Modulation, cdmaOne, cdma2000, 1xEV-DO, W-CDMA, GSM, EDGE, NADC, or PDC mode to use this command. Use INSTRument:SElect to set the mode.

History: E4406A:  
Short form changed from LENgth to LENGth, A.03.00

### Spectrum—FFT Minimum Points in Resolution BW

**[ :SENSe ] :SPECTrum:FFT:RBWPoints <real>**

**[ :SENSe ] :SPECTrum:FFT:RBWPoints?**

Set the minimum number of data points that will be used inside the resolution bandwidth. The value is ignored if length control is set to manual. This is an advanced control that normally does not need to be changed.

Factory Preset: 1.30

Range: 0.1 to 100

Remarks: To use this command for E4406A, the appropriate mode should be selected with INSTRument:SElect.

For PSA you must be in the Basic, Analog Modulation,



cdmaOne, cdma2000, 1xEV-DO, W-CDMA, GSM, EDGE, NADC, or PDC mode to use this command. Use INSTRument:SElect to set the mode.

### Spectrum—Window Delay

**[ :SENSe ] :SPECTrum:FFT:WINDow:DElay <real>**

**[ :SENSe ] :SPECTrum:FFT:WINDow:DElay?**

Set the FFT window delay to move the FFT window from its nominal position of being centered within the time capture. This function is not available from the front panel. It is an advanced control that normally does not need to be changed.

Factory Preset: 0

Range: -10.0 to +10.0s

Default Unit: seconds

Remarks: To use this command for E4406A, the appropriate mode should be selected with INSTRument:SElect.

For PSA you must be in the Basic, Analog Modulation, cdmaOne, cdma2000, 1xEV-DO, W-CDMA, GSM, EDGE, NADC, or PDC mode to use this command. Use INSTRument:SElect to set the mode.

### Spectrum—Window Length

**[ :SENSe ] :SPECTrum:FFT:WINDow:LENGth <integer>**

**[ :SENSe ] :SPECTrum:FFT:WINDow:LENGth?**

Set the FFT window length. This value is only used if length control is set to manual. This is an advanced control that normally does not need to be changed.

Factory Preset: 706

Range: 8 to 1,048,576

Remarks: To use this command for E4406A, the appropriate mode should be selected with INSTRument:SElect.

For PSA you must be in the Basic, Analog Modulation, cdmaOne, cdma2000, 1xEV-DO, W-CDMA, GSM, EDGE, NADC, or PDC mode to use this command. Use INSTRument:SElect to set the mode.

History: E4406A:  
Short form changed from LENGth to LENGth, A.03.00

## Spectrum—FFT Window

```
[ :SENSe ] :SPECTrum:FFT:WINDow [ :TYPE ]  
BH4Tap | BLACkman | FLATtop | GAUSSian | HAMMING | HANNing | KB70 | KB90 |  
KB110 | UNIFORM
```

```
[ :SENSe ] :SPECTrum:FFT:WINDow [ :TYPE ] ?
```

Select the FFT window type.

BH4Tap - Blackman Harris with 4 taps

BLACkman - Blackman

FLATtop - flat top, the default (for high amplitude accuracy)

GAUSSian - Gaussian with alpha of 3.5

HAMMING - Hamming

HANNing - Hanning

KB70, 90, and 110 - Kaiser Bessel with sidelobes at -70, -90, or -110 dBc

UNIFORM - no window is used. (This is the unity response.)

Factory Preset: FLATtop

Remarks: This selection affects the acquisition point quantity and the FFT size, based on the resolution bandwidth selected.

To use this command for E4406A, the appropriate mode should be selected with INSTRUMENT:SElect.

For PSA you must be in the Basic, Analog Modulation, cdmaOne, cdma2000, 1xEV-DO, W-CDMA, GSM, EDGE, NADC, or PDC mode to use this command. Use INSTRUMENT:SElect to set the mode.

## Spectrum—Frequency Span

```
[ :SENSe ] :SPECTrum:FREQuency:SPAN <freq>
```

```
[ :SENSe ] :SPECTrum:FREQuency:SPAN?
```

Set the frequency span to be measured.

Factory Preset: 1.0 MHz

100.0 kHz for iDEN mode (E4406A)

Range: 10 Hz to 10.0 MHz (15 MHz when Service mode is selected)

Default Unit: Hz

Remarks: The actual measured span will generally be slightly wider due to the finite resolution of the FFT.

To use this command for E4406A, the appropriate mode should be selected with INSTRUMENT:SElect.

For PSA you must be in the Basic, Analog Modulation, cdmaOne, cdma2000, 1xEV-DO, W-CDMA, GSM, EDGE, NADC, or PDC mode to use this command. Use INSTRUMENT:SElect to set the mode.

### Spectrum—Sweep (Acquisition) Time

**[ :SENSE ] :SPECTrum:SWEep:TIME [ :VALue ] <time>**

**[ :SENSE ] :SPECTrum:SWEep:TIME?**

Set the sweep (measurement acquisition) time. It is used to specify the length of the time capture record. If the value you specify is less than the capture time required for the specified span and resolution bandwidth, the value is ignored. The value is set at its auto value when auto is selected. This is an advanced control that normally does not need to be changed.

Factory Preset: 18.83  $\mu$ s

15.059 ms, for iDEN mode (E4406A)

Range: 100 ns to 10 s

Default Unit: seconds

Remarks: To use this command for E4406A, the appropriate mode should be selected with INSTRUMENT:SElect.

For PSA you must be in the Basic, Analog Modulation, cdmaOne, cdma2000, 1xEV-DO, W-CDMA, GSM, EDGE, NADC, or PDC mode to use this command. Use INSTRUMENT:SElect to set the mode.

### Spectrum—Sweep (Acquisition) Time Auto

**[ :SENSE ] :SPECTrum:SWEep:TIME:AUTO OFF | ON | 0 | 1**

**[ :SENSE ] :SPECTrum:SWEep:TIME:AUTO**

Select auto or manual control of the sweep (acquisition) time. This is an advanced control that normally does not need to be changed.

AUTO - couples the Sweep Time to the Frequency Span and Resolution BW

Manual - the Sweep Time is uncoupled from the Frequency Span and Resolution BW.

Factory Preset: AUTO

Remarks: To use this command for E4406A, the appropriate mode should be selected with INSTRUMENT:SElect.

For PSA you must be in the Basic, Analog Modulation, cdmaOne, cdma2000, 1xEV-DO, W-CDMA, GSM, EDGE, NADC, or PDC mode to use this command. Use INSTRUMENT:SElect to set the mode.

### Spectrum—Trigger Source

```
[ :SENSe ] :SPECTrum:TRIGger:SOURce  
EXTernal [1] | EXTernal2 | FRAME | IF | LINE | IMMEDIATE  
| RFBurst
```

```
[ :SENSe ] :SPECTrum:TRIGger:SOURce?
```

Select the trigger source used to control the data acquisitions.

EXTernal1 - front panel external trigger input

EXTernal2 - rear panel external trigger input

FRAME - internal frame timer from front panel input

IF - internal IF envelope (video) trigger

LINE - internal line trigger

IMMEDIATE - the next data acquisition is immediately taken (also called free run)

RFBurst - wideband RF burst envelope trigger that has automatic level control for periodic burst signals

Factory Preset: IMMEDIATE (free run)

RFBurst, for GSM, iDEN mode

Remarks: To use this command for E4406A, the appropriate mode should be selected with INSTRUMENT:SElect.

For PSA you must be in the Basic, Analog Modulation, cdmaOne, cdma2000, 1xEV-DO, W-CDMA, GSM, EDGE, NADC, or PDC mode to use this command. Use INSTRUMENT:SElect to set the mode.



## Synchronization Commands

### Sync Alignment

**[ :SENSe ] :SYNC:ALIGnment GSM|HBIT**

**[ :SENSe ] :SYNC:ALIGnment?**

Select the sync alignment to be either to the GSM standard or the standard offset by 1/2 bit.

GSM - burst alignment as defined in the GSM standard

HBIT - burst alignment is advanced by 1/2 bit, which corresponds to an earlier interpretation of the GSM standard

Factory Preset: HBIT

Remarks: Global to the current mode.

You must be in the GSM, EDGE mode to use this command. Use INSTRument:SElect to set the mode.

Front Panel

Access: **Mode Setup, Demod, Burst Align**

### Sync Burst RF Amplitude Delay

**[ :SENSe ] :SYNC:BURSt:RFAMplitude:DELay <time>**

**[ :SENSe ] :SYNC:BURSt:RFAMplitude:DELay?**

Set the delay for the RF amplitude sync.

Factory Preset: 0 s

Range: -100 ms to 100 ms

Default Unit: seconds

Remarks: Global to the current mode.

You must be in the GSM, EDGE mode to use this command. Use INSTRument:SElect to set the mode.

Front Panel

Access: **Mode Setup, Trigger, RF Sync Delay**

### Burst Search Threshold

**[ :SENSe ] :SYNC:BURSt:STHreshold <rel\_power>**

**[ :SENSe ] :SYNC:BURSt:STHreshold?**

Set the relative power threshold, which is used to determine the

timeslots that will be included in the search for GSM bursts. For measurements that have burst sync set to training sequence, these bursts will be the only ones that will be searched for valid TSC's (training sequence codes). The threshold power is relative to the peak power of the highest power timeslot. This is useful when measuring a BTS with different power levels in different timeslots, and you want to exclude bursts with lower power levels.

Factory Preset: -10 dB

Range: -200 to -0.01 dB

Default Unit: dB

Remarks: You must be in the GSM, EDGE mode to use this command. Use INSTRument:SElect to set the mode.

Front Panel

Access: **Mode Setup, Trigger, Slot Threshold**

## GMSK Transmit Band Spurs Measurement

Commands for querying the transmit band spurs measurement results and for setting to the default values are found in the [“MEASure Group of Commands” on page 519](#). The equivalent front panel keys for the parameters described in the following commands, are found under the **Meas Setup** key, after the **GMSK TxBand Spur** measurement has been selected from the **MEASURE** key menu.

### Transmit Band Spurs—Average Count

**[ :SENSe ] :TSPur:AVERage:COUNT <integer>**

**[ :SENSe ] :TSPur:AVERage:COUNT?**

Set the number of data acquisitions that will be averaged. After the specified number of average counts, the averaging termination setting determines the averaging action.

Factory Preset: 15

Range: 1 to 10,000

Remarks: You must be in the GSM, EDGE mode to use this command. Use INSTRument:SElect to set the mode.

History: E4406A:  
Version A.03.00 or later

### Transmit Band Spurs—Averaging State

**[ :SENSe ] :TSPur:AVERage [ :STATE ] OFF | ON | 0 | 1**

**[ :SENSe ] :TSPur:AVERAge [ :STATe ] ?**

Turn averaging on or off.

Factory Preset: ON

Remarks: You must be in the GSM, EDGE mode to use this command. Use INSTRument:SElect to set the mode.

History: E4406A:  
Version A.03.00 or later

### Transmit Band Spurs—Averaging Termination Control

**[ :SENSe ] :TSPur:AVERAge:TCONtrol EXPonential | REPeat**

**[ :SENSe ] :TSPur:AVERAge:TCONtrol?**

Select the type of termination control used for the averaging function. This determines the averaging action after the specified number of data acquisitions (average count) is reached.

EXPonential - After the average count has been reached, each successive data acquisition is exponentially weighted and combined with the existing average.

REPeat - After reaching the average count, the averaging is reset and a new average is started.

Factory Preset: REPeat

Remarks: You must be in the GSM, EDGE mode to use this command. Use INSTRument:SElect to set the mode.

History: E4406A:  
Version A.03.00 or later

### Transmit Band Spurs—Averaging Type

**[ :SENSe ] :TSPur:AVERAge:TYPE LOG | MAXimum | RMS**

**[ :SENSe ] :TSPur:AVERAge:TYPE?**

Select the type of averaging.

LOG - The log of the power is averaged. (This is also known as video averaging.)

MAXimum - The maximum values are retained.

RMS - The power is averaged, providing the rms of the voltage.

Factory Preset: MAXimum

Remarks: You must be in the GSM, EDGE mode to use this



command. Use INSTRument:SElect to set the mode.

History: E4406A:  
Version A.03.00 or later

### Transmit Band Spurs—Type

[ :SENSe ] :TSPur :TYPE EXAMine | FULL

[ :SENSe ] :TSPur :TYPE?

Select the measurement type.

EXAMine - measures spurs in all the valid segments and then displays the segment that has the worst spur

FULL - continuously measures the spurs in all the valid segments

Factory Preset: FULL

Remarks: You must be in the GSM, EDGE mode to use this command. Use INSTRument:SElect to set the mode.

History: E4406A:  
Version A.03.00 or later

## Transmit Power Measurement

Commands for querying the transmit power measurement results and for setting to the default values are found in the “MEASure Group of Commands” on page 519. The equivalent front panel keys for the parameters described in the following commands, are found under the **Meas Setup** key, after the **Transmit Power** measurement has been selected from the **MEASURE** key menu.

### Transmit Power—Number of Bursts Averaged

**[ :SENSe ] :TXPower:AVERage:COUNT <integer>**

**[ :SENSe ] :TXPower:AVERage:COUNT?**

Set the number of bursts that will be averaged. After the specified number of bursts (average counts), the averaging mode (termination control) setting determines the averaging action.

Factory Preset: 50

Range: 1 to 10,000

Remarks: You must be in the GSM, EDGE mode to use this command. Use INSTRument:SElect to set the mode.

### Transmit Power—Averaging State

**[ :SENSe ] :TXPower:AVERage[:STATe] OFF|ON|0|1**

**[ :SENSe ] :TXPower:AVERage[:STATe]?**

Turn averaging on or off.

Factory Preset: ON

Remarks: You must be in the GSM, EDGE mode to use this command. Use INSTRument:SElect to set the mode.

### Transmit Power—Averaging Termination Control

**[ :SENSe ] :TXPower:AVERage:TCONtrol EXPonential|REPeat**

**[ :SENSe ] :TXPower:AVERage:TCONtrol?**

Select the type of termination control used for the averaging function. This determines the averaging action after the specified number of frames (average count) is reached.

EXPonential - After the average count has been reached, each successive data acquisition is exponentially weighted and combined with the existing average.

REPeat - After reaching the average count, the averaging is reset

and a new average is started.

Factory Preset: EXPonential

Remarks: You must be in the GSM, EDGE mode to use this command. Use INSTRument:SElect to set the mode.

### Transmit Power—Averaging Type

**[ :SENSe ] :TXPower :AVERage :TYPE | LOG | MAX | MIN | RMS**

**[ :SENSe ] :TXPower :AVERage :TYPE?**

Select the type of averaging to be performed.

- LOG - The log of the power is averaged. (This is also known as video averaging.)
- MAXimum - The maximum values are retained.
- MINimum - The minimum values are retained.
- RMS - The power is averaged, providing the rms of the voltage.

Factory Preset: RMS

Remarks: You must be in the GSM, EDGE mode to use this command. Use INSTRument:SElect to set the mode.

### Transmit Power—Resolution BW

**[ :SENSe ] :TXPower :BANDwidth | BWIDth [ :RESolution ] <freq>**

**[ :SENSe ] :TXPower :BANDwidth | BWIDth [ :RESolution ] ?**

Set the resolution BW. This is an advanced control that normally does not need to be changed. Setting it to a value other than the factory default, may cause invalid measurement results.

Factory Preset: 500 kHz

Range: 1 kHz to 5 MHz

Default Unit: Hz

Remarks: You must be in the GSM, EDGE mode to use this command. Use INSTRument:SElect to set the mode.

### Transmit Power—Resolution BW Filter Type

**[ :SENSe ] :TXPower :BANDwidth | BWIDth [ :RESolution ] :TYPE  
FLAT | GAUSSian**

**[ :SENSe ] :TXPower :BANDwidth | BWIDth [ :RESolution ] :TYPE?**

Select the type of resolution BW filter. This is an advanced control that normally does not need to be changed. Setting this to a value other than the factory default, may cause invalid measurement results.

Flat top (FLAT) - a filter with a flat amplitude response, which provides the best amplitude accuracy.

GAUSSian - a filter with Gaussian characteristics, which provides the best pulse response.

Factory Preset: GAUSSian

Remarks: You must be in the GSM, EDGE mode to use this command. Use INSTRument:SElect to set the mode.

### Transmit Power—Sweep Time

**[ :SENSe ] :TXPower:SWEep:TIME <integer>**

**[ :SENSe ] :TXPower:SWEep:TIME?**

Set the number of slots which are used in each data acquisition. Each slot is approximately equal to 600 ms.

Factory Preset: 1

Range: 1 to 50 time slots (for resolution BW = 500 kHz)

Remarks: You must be in the GSM, EDGE or Service mode to use this command. Use INSTRument:SElect to set the mode.

### Transmit Power—Threshold Level

**[ :SENSe ] :TXPower:THReshold <power>**

**[ :SENSe ] :TXPower:THReshold?**

Set the amplitude threshold level. Only the data above the threshold level is kept and used to compute the average transmit carrier power.

Factory Preset: -6.0 dB

Range: -100 dB to 0 dB, for relative mode  
-100 dBm to +30 dB, for absolute mode

Default Unit: dB for relative mode  
dBm for absolute mode

Remarks: The command (SENSe:TXPower:THReshold:TYPE ABSolute | RELative) determines whether this command is setting an absolute or a relative power level.

You must be in the GSM, EDGE mode to use this command. Use INSTRUMENT:SELEct to set the mode.

### Transmit Power—Threshold Type

**[ :SENSE ] :TXPower:THReshold:TYPE ABSolute | RELative**

**[ :SENSe ] :TXPower:THReshold:TYPE?**

Select auto or manual control of the threshold level.

ABSolute - threshold value is set to an absolute power level

RELative - threshold value is set relative to the reference

Factory Preset: RELative

Remarks: You must be in the GSM, EDGE mode to use this command. Use INSTRUMENT:SELEct to set the mode.

### Transmit Power—Trigger Source

**[ :SENSE ] :TXPower:TRIGger:SOURce**

**EXTernal [1] | EXTernal2 | IF | IMMEDIATE | RFBurst**

**[ :SENSe ] :TXPower:TRIGger:SOURce?**

Select the trigger source used to control the data acquisitions.

EXTernal 1 - front panel external trigger input

EXTernal 2 - rear panel external trigger input

IF - internal IF envelope (video) trigger

IMMEDIATE - the next data acquisition is immediately taken (also called free run)

RFBurst - wideband RF burst envelope trigger that has automatic level control for periodic burst signals.

Factory Preset: RFBurst

Remarks: You must be in the GSM, EDGE mode to use this command. Use INSTRUMENT:SELEct to set the mode.

## Waveform (Time-Domain) Measurement

Commands for querying the waveform measurement results and for setting to the default values are found in the “[MEASure Group of Commands](#)” on page 519. The equivalent front panel keys for the parameters described in the following commands, are found under the **Meas Setup** key, after the **Waveform (Time Domain)** measurement has been selected from the **MEASURE** key menu.

### Waveform—Data Acquisition Packing

```
[ :SENSe ] :WAVEform:ACQuisition:PACKing  
AUTO | LONG | MEDium | SHORt
```

```
[ :SENSe ] :WAVEform:ACQuisition:PACKing?
```

This is an advanced control that normally does not need to be changed.

Factory Preset: AUTO

Remarks: To use this command for E4406A, the appropriate mode should be selected with INSTRument:SElect.

For PSA you must be in the Basic, Analog Modulation, cdmaOne, cdma2000, 1xEV-DO, W-CDMA, GSM, EDGE, NADC, or PDC mode to use this command. Use INSTRument:SElect to set the mode.

### Waveform—ADC Dither Control

```
[ :SENSe ] :WAVEform:ADC:DITHer [ :STATe ] AUTO | ON | OFF | 2 | 1 | 0
```

```
[ :SENSe ] :WAVEform:ADC:DITHer [ :STATe ] ?
```

Turn the ADC dither on or off. This is an advanced control that normally does not need to be changed. The “ADC dither” refers to the introduction of noise to the digitized steps of the analog-to-digital converter; the result is an improvement in amplitude accuracy.

The Option 122 wideband ADC dither uses  
SENSe:WAVEform:WBIF:ADC:DITHer.

Factory Preset: AUTO

Remarks: To use this command for E4406A, the appropriate mode should be selected with INSTRument:SElect.

For PSA you must be in the Basic, Analog Modulation, cdmaOne, cdma2000, 1xEV-DO, W-CDMA, GSM, EDGE, NADC, or PDC mode to use this command. Use INSTRument:SElect to set the mode.

### Waveform—Pre-ADC Bandpass Filter

**[ :SENSE ] :WAVEform:ADC:FILTer [ :STATe ] OFF | ON | 0 | 1**

**[ :SENSe ] :WAVEform:ADC:FILTer [ :STATe ] ?**

Turn the pre-ADC bandpass filter on or off. This is an Advanced control that normally does not need to be changed.

Preset: OFF

Remarks: To use this command for E4406A, the appropriate mode should be selected with INSTRUMENT:SELEct.

For PSA you must be in the Basic, Analog Modulation, cdmaOne, cdma2000, 1xEV-DO, W-CDMA, GSM, EDGE, NADC, or PDC mode to use this command. Use INSTRUMENT:SELEct to set the mode.

### Waveform—ADC Range

12-bit ADC E4406A

**[ :SENSE ] :WAVEform:ADC:RANGe**

**AUTO | APEak | APLOCK | GROund | M6 | P0 | P6 | P12 | P18 | P24**

PSA and 14-bit ADC E4406A

**[ :SENSE ] :WAVEform:ADC:RANGe**

**AUTO | APEak | APLOCK | GROund | NONE | P0 | P6 | P12 | P18**

**[ :SENSe ] :WAVEform:ADC:RANGe?**

Select the range for the gain-ranging that is done in front of the ADC. This is an Advanced control that normally does not need to be changed.

AUTO - automatic range

Auto Peak (APEak) - automatically peak the range

Auto Peak Lock (APLOCK)- automatically peak lock the range

GROund - ground

NONE - (PSA and 14-bit ADC E4406A) turn off auto-ranging without making any changes to the current setting.

M6 - (12-bit ADC E4406A) subtracts 6 dB of fixed gain across the range

P0 to P18 - (PSA and 14-bit ADC E4406A) adds 0 to 18 dB of fixed gain across the range

P0 to P24 - (12-bit ADC E4406A) adds 0 to 24 dB of fixed gain across the range

Factory Preset: AUTO

Remarks: To use this command for E4406A, the appropriate mode should be selected with INSTRUMENT:SElect.

For PSA you must be in the Basic, Analog Modulation, cdmaOne, cdma2000, 1xEV-DO, W-CDMA, GSM, EDGE, NADC, or PDC mode to use this command. Use INSTRUMENT:SElect to set the mode.

### Waveform—Sample Period (Aperture) Setting

**[ :SENSe ] :WAVeform:APERTure?**

Returns the time between samples (sample period or aperture). This value is based on current resolution bandwidth, filter type, and decimation factor. Sample rate is the reciprocal of the period.

Remarks: To use this command for E4406A, the appropriate mode should be selected with INSTRUMENT:SElect.

For PSA you must be in the Basic, Analog Modulation, cdmaOne, cdma2000, 1xEV-DO, W-CDMA, GSM, EDGE, NADC, or PDC mode to use this command. Use INSTRUMENT:SElect to set the mode.

History: PSA added revision A.04.00.

### Waveform—Number of Averages

**[ :SENSe ] :WAVeform:AVERAge:COUNT <integer>**

**[ :SENSe ] :WAVeform:AVERAge:COUNT?**

Set the number of sweeps that will be averaged. After the specified number of sweeps (average counts), the averaging mode (terminal control) setting determines the averaging action.

Factory Preset: 10

Range: 1 to 10,000

Remarks: To use this command for E4406A, the appropriate mode should be selected with INSTRUMENT:SElect.

For PSA you must be in the Basic, Analog Modulation, cdmaOne, cdma2000, 1xEV-DO, W-CDMA, GSM, EDGE, NADC, or PDC mode to use this command. Use INSTRUMENT:SElect to set the mode.

### Waveform—Averaging State

**[ :SENSe ] :WAVeform:AVERAge[:STATe] OFF|ON|0|1**



**[ :SENSE ] :WAVEform:AVERAge [ :STATe ] ?**

Turn averaging on or off.

Factory Preset: OFF

Remarks: To use this command for E4406A, the appropriate mode should be selected with INSTRUMENT:SElect.

For PSA you must be in the Basic, Analog Modulation, cdmaOne, cdma2000, 1xEV-DO, W-CDMA, GSM, EDGE, NADC, or PDC mode to use this command. Use INSTRUMENT:SElect to set the mode.

### Waveform—Averaging Termination Control

**[ :SENSE ] :WAVEform:AVERAge:TCONtrol EXPonential | REPeat**

**[ :SENSE ] :WAVEform:AVERAge:TCONtrol?**

Select the type of termination control used for the averaging function. This determines the averaging action after the specified number of ‘sweeps’ (average count) is reached.

EXPonential - After the average count has been reached, each successive data acquisition is exponentially weighted and combined with the existing average.

REPeat - After reaching the average count, the averaging is reset and a new average is started.

Factory Preset: EXPonential

Remarks: To use this command for E4406A, the appropriate mode should be selected with INSTRUMENT:SElect.

For PSA you must be in the Basic, Analog Modulation, cdmaOne, cdma2000, 1xEV-DO, W-CDMA, GSM, EDGE, NADC, or PDC mode to use this command. Use INSTRUMENT:SElect to set the mode.

### Waveform—Averaging Type

**[ :SENSE ] :WAVEform:AVERAge:TYPE  
LOG | MAXimum | MINimum | RMS | SCALar**

**[ :SENSE ] :WAVEform:AVERAge:TYPE?**

Select the type of averaging.

LOG - The log of the power is averaged. (This is also known as video averaging.)

MAXimum - The maximum values are retained.

MINimum - The minimum values are retained.

RMS - The power is averaged, providing the rms of the voltage.

Factory Preset: RMS

Remarks: To use this command for E4406A, the appropriate mode should be selected with INSTRUMENT:SElect.

For PSA you must be in the Basic, Analog Modulation, cdmaOne, cdma2000, 1xEV-DO, W-CDMA, GSM, EDGE, NADC, or PDC mode to use this command. Use INSTRUMENT:SElect to set the mode.

### Waveform—Resolution BW

```
[ :SENSe ] :WAVeform: BANDwidth | BWIDth [ :RESolution ] <freq>
```

```
[ :SENSe ] :WAVeform: BANDwidth | BWIDth [ :RESolution ] ?
```

Set the resolution bandwidth. This value is ignored if the function is auto-coupled.

Factory Preset: 20.0 kHz for NADC, PDC, cdma2000, W-CDMA, Basic, Service (E4406A)  
500.0 kHz for GSM  
2.0 MHz for cdmaOne

Range: 1.0 kHz to 8.0 MHz when  
SENSe:WAV:BWID:RES:TYPE GAUSSian  
100 mHz to 10.0 MHz when  
SENSe:WAV:BWID:RES:TYPE FLATtop  
PSA: 10.0 Hz to 10 MHz, for Basic Mode  
PSA Option 122: 10 kHz to 80 MHz, for Basic Mode

Remarks: To use this command for E4406A, the appropriate mode should be selected with INSTRUMENT:SElect.

For PSA you must be in the Basic, Analog Modulation, cdmaOne, cdma2000, 1xEV-DO, W-CDMA, GSM, EDGE, NADC, or PDC mode to use this command. Use INSTRUMENT:SElect to set the mode.

Bandwidths > 6.7 MHz will require a slight increase in measurement time.

History: PSA modified in revision A.06.00.

### Waveform—Query Actual Resolution Bandwidth

```
[ :SENSe ] :WAVeform: BANDwidth [ :RESolution ] :ACTual?
```

Due to memory constraints the actual resolution bandwidth value may vary from the value entered by the user. For most applications the resulting difference in value is inconsequential but for some it is necessary to know the actual value; this query retrieves the actual resolution bandwidth value.

Remarks: To use this command for E4406A, the appropriate mode should be selected with INSTRUMENT:SElect.

For PSA you must be in the Basic, Analog Modulation, cdmaOne, cdma2000, 1xEV-DO, W-CDMA, GSM, EDGE, NADC, or PDC mode to use this command. Use INSTRUMENT:SElect to set the mode.

History: E4406A: added in version A.05.00 or later

### Waveform—Resolution BW Filter Type

**[ :SENSE ] :WAVEform: BANDwidth | BWIDth [ :RESolution ] :TYPE  
FLATtop | GAUSSian**

**[ :SENSE ] :WAVEform: BANDwidth | BWIDth [ :RESolution ] :TYPE?**

Select the type of Resolution BW filter that is used. This is an Advanced control that normally does not need to be changed.

FLATtop - a filter with a flat amplitude response, which provides the best amplitude accuracy.

GAUSSian - a filter with Gaussian characteristics, which provides the best pulse response.

Factory Preset: GAUSSian

Remarks: To use this command for E4406A, the appropriate mode should be selected with INSTRUMENT:SElect.

For PSA you must be in the Basic, Analog Modulation, cdmaOne, cdma2000, 1xEV-DO, W-CDMA, GSM, EDGE, NADC, or PDC mode to use this command. Use INSTRUMENT:SElect to set the mode.

### Waveform—Decimation of Waveform Display

**[ :SENSE ] :WAVEform: DECimate [ :FACTor ] <integer>**

**[ :SENSE ] :WAVEform: DECimate [ :FACTor ] ?**

Set the amount of data decimation done on the IQ data stream. For example, if 4 is selected, three out of every four data points will be thrown away. So every 4th data point will be kept.

Factory Preset: 1

Range: 1 to 4

Remarks: To use this command for E4406A, the appropriate mode should be selected with INSTRUMENT:SElect.

For PSA you must be in the Basic, Analog Modulation, cdmaOne, cdma2000, 1xEV-DO, W-CDMA, GSM, EDGE, NADC, or PDC mode to use this command. Use INSTRUMENT:SElect to set the mode.

### Waveform—Control Decimation of Waveform Display

**[ :SENSe ] :WAVEform:DECimate:STATE OFF|ON|0|1**

**[ :SENSe ] :WAVEform:DECimate:STATE?**

Set the amount of data decimation done by the hardware in order to decrease the number of acquired points in a long capture time. This is the amount of data that the measurement ignores.

Factory Preset: OFF

Remarks: To use this command for E4406A, the appropriate mode should be selected with INSTRUMENT:SElect.

For PSA you must be in the Basic, Analog Modulation, cdmaOne, cdma2000, 1xEV-DO, W-CDMA, GSM, EDGE, NADC, or PDC mode to use this command. Use INSTRUMENT:SElect to set the mode.

### Waveform—Sweep (Acquisition) Time

**[ :SENSe ] :WAVEform:SWEep:TIME <time>**

**[ :SENSe ] :WAVEform:SWEep:TIME?**

Set the measurement acquisition time. It is used to specify the length of the time capture record.

Factory Preset: 2.0 ms

100.0 ms, for Basic Mode (PSA)

10.0 ms, for NADC, PDC

15.0 ms, for iDEN mode (E4406A)

Range: 100 ns to 100 s

Default Unit: seconds

Remarks: To use this command for E4406A, the appropriate mode should be selected with INSTRUMENT:SElect.

For PSA you must be in the Basic, Analog Modulation,

cdmaOne, cdma2000, 1xEV-DO, W-CDMA, GSM, EDGE, NADC, or PDC mode to use this command. Use INSTRument:SElect to set the mode.

### Waveform—Trigger Source

```
[ :SENSe ] :WAVeform:TRIGger:SOURce  
EXTErnal [1] | EXTErnal2 | FRAMe | IF | IMMEDIATE  
| LINE | RFBurst
```

```
[ :SENSe ] :WAVeform:TRIGger:SOURce?
```

Select the trigger source used to control the data acquisitions.

EXTErnal 1 - front panel external trigger input

EXTErnal 2 - rear panel external trigger input

FRAMe - internal frame timer from front panel input

IF - internal IF envelope (video) trigger

IMMEDIATE - the next data acquisition is immediately taken (also called free run)

LINE - internal line trigger

RFBurst - wideband RF burst envelope trigger that has automatic level control for periodic burst signals (not available when using Option 122)

Factory Preset: IMMEDIATE (free run), for Basic, cdmaOne, NADC, PDC mode

RFBurst, for GSM, iDEN (E4406A) modes

Remarks: To use this command for E4406A, the appropriate mode should be selected with INSTRument:SElect.

For PSA you must be in the Basic, Analog Modulation, cdmaOne, cdma2000, 1xEV-DO, W-CDMA, GSM, EDGE, NADC, or PDC mode to use this command. Use INSTRument:SElect to set the mode.

---

## TRIGger Subsystem

The Trigger Subsystem is used to set the controls and parameters associated with triggering the data acquisitions. Other trigger-related commands are found in the INITiate and ABORt subsystems.

The trigger parameters are global within a selected Mode. The commands in the TRIGger subsystem set up the way the triggers function, but selection of the trigger source is made from each measurement. There is a separate trigger source command in the SENSE:<meas> subsystem for each measurement. The equivalent front panel keys for the parameters described in the following commands, can be found under the **Mode Setup, Trigger** key.

### Automatic Trigger Control

**:TRIGger[:SEQuence]:AUTO:STATe OFF | ON | 0 | 1**

**:TRIGger[:SEQuence]:AUTO:STATe?**

Turns the automatic trigger function on and off. This function causes a trigger to occur if the designated time has elapsed and no trigger occurred. It can be used with unpredictable trigger sources, like external or burst, to make sure a measurement is initiated even if a trigger doesn't occur. Use TRIGger[:SEQuence]:AUTO[:TIME] to set the time limit.

Factory Preset  
and \*RST      Off for cdma2000, W-CDMA, NADC, PDC, 1xEV-DO

Front Panel  
Access      **Mode Setup, Trigger, Auto Trig**

### Automatic Trigger Time

**:TRIGger[:SEQuence]:AUTO[:TIME] <time>**

**:TRIGger[:SEQuence]:AUTO[:TIME]?**

After the measurement is activated the instrument will take a data acquisition immediately upon receiving a signal from the selected trigger source. If no trigger signal is received by the end of the time specified in this command, a data acquisition is taken anyway. TRIGger[:SEQuence]:AUTO:STATE must be on.

Factory Preset: 100.0 ms

Range:            1.0 ms to 1000.0 s  
                    0.0 to 1000.0 s for cdma2000, W-CDMA, 1xEV-DO

Default Unit: seconds  
Front Panel  
Access **Mode Setup, Trigger, Auto Trig**

## External Trigger Delay

**:TRIGger[:SEQuence]:EXTernal[1] | 2:DELay <time>**

**:TRIGger[:SEQuence]:EXTernal[1] | 2:DELay?**

Set the trigger delay when using an external trigger. Set the trigger value to zero (0) seconds to turn off the delay.

EXT or EXT1 is the front panel trigger input.

EXT2 is the rear panel trigger input.

Factory Preset: 0.0 s

Range: -100.0 ms to 500.0 ms

Default Unit: seconds

Front Panel  
Access: **Mode Setup, Trigger, Ext Rear (or Ext Front), Delay**

## External Trigger Level

**:TRIGger[:SEQuence]:EXTernal[1] | 2:LEVel <voltage>**

**:TRIGger[:SEQuence]:EXTernal[1] | 2:LEVel?**

Set the trigger level when using an external trigger input.

EXT or EXT1 is the front panel trigger input

EXT2 is the rear panel trigger input

Factory Preset: 2.0 V

Range: -5.0 to +5.0 V

Default Unit: volts

Front Panel  
Access: **Mode Setup, Trigger, Ext Rear (or Ext Front), Level**

## External Trigger Slope

**:TRIGger[:SEQuence]:EXTernal[1] | 2:SLOPe**

**NEGative | POSitive**

### **:TRIGger[:SEQuence]:EXTernal[1] | 2:SLOPe?**

Sets the trigger slope of an external trigger input to either NEGative or POSitive.

EXT or EXT1 is the front panel trigger input.

EXT2 is the rear panel trigger input.

Factory Preset: Positive

Front Panel

Access: **Mode Setup, Trigger, Ext Rear (or Ext Front), Slope**

### **Frame Trigger Adjust**

#### **:TRIGger[:SEQuence]:FRAME:ADJust <time>**

Lets you advance the phase of the frame trigger by the specified amount. It does not change the period of the trigger waveform. If the command is sent multiple times, it advances the phase of the frame trigger more each time it is sent.

Factory Preset: 0.0 s

Range: 0.0 to 10.0 s

Default Unit: seconds

Front Panel

Access: None

### **Frame Trigger Period**

#### **:TRIGger[:SEQuence]:FRAME:PERiod <time>**

#### **:TRIGger[:SEQuence]:FRAME:PERiod?**

Set the frame period that you want when using the external frame timer trigger. If the traffic rate is changed, the value of the frame period is initialized to the preset value.

Factory Preset: 250.0  $\mu$ s for Basic, cdmaOne

4.615383 ms, for GSM

26.666667 ms for cdma2000 and 1xEV-DO

10.0 ms (1 radio frame) for W-CDMA

90.0 ms for iDEN (E4406A)

20.0 ms with rate=full for NADC, PDC

40.0 ms with rate=half for NADC, PDC

Range: 0.0 ms to 559.0 ms for Basic, cdmaOne, GSM,



cdma2000, W-CDMA, 1xEV-DO

1.0 ms to 559.0 ms for iDEN (E4406A), NADC, PDC

Default Unit: seconds

Front Panel

Access: **Mode Setup, Trigger, Frame Timer, Period**

## Frame Trigger Sync Source

**:TRIGger[:SEQuence]:FRAMe:SYNC EXTFront | EXTReAr | OFF**

**:TRIGger[:SEQuence]:FRAMe:SYNC?**

Selects the input port location for the external frame trigger that you are using.

Factory Preset: Off

Remarks: You must be in the Basic, cdmaOne, EDGE (w/GSM), GSM, iDEN (E4406A), NADC, PDC, Service mode to use this command. Use INSTRument:SElect to set the mode.

Front Panel

Access: **Mode Setup, Trigger, Frame Timer, Sync Source**

History Changed firmware revision A.05.00.

## Frame Trigger Synchronization Offset

**:TRIGger[:SEQuence]:FRAMe:SYNC:OFFSet <time>**

**:TRIGger[:SEQuence]:FRAMe:SYNC:OFFSet?**

Lets you adjust the frame triggering with respect to the external trigger input that you are using.

Factory Preset: 0.0 s

Range: 0.0 to 10.0 s

Default Unit: seconds

Remarks: You must be in the Basic, cdmaOne, GSM, EDGE, iDEN (E4406A), NADC, PDC, Service mode to use this command. Use INSTRument:SElect to set the mode.

History: Revision A.03.27 or later

Front Panel

Access: **Mode Setup, Trigger, Frame Timer, Offset**

## Trigger Holdoff

**:TRIGger[:SEQuence]:HOLDoff <time>**

**:TRIGger[:SEQuence]:HOLDoff?**

Set a value of the holdoff time between triggers. After a trigger, another trigger will not be allowed until the holdoff time expires. This parameter affects all trigger sources.

Factory Preset: 0.0 s

20.0 ms for iDEN (E4406A)

10.0 ms for NADC or PDC

Range: 0.0 to 500.0 ms

Default Unit: seconds

Front Panel

Access: **Mode Setup, Trigger, Trigger Holdoff**

## Video (IF) Trigger Delay

**:TRIGger[:SEQuence]:IF:DELAy <time>**

**:TRIGger[:SEQuence]:IF:DELAy?**

Set a value of the trigger delay of the IF (video) trigger (signal after the resolution BW filter).

Factory Preset: 0.0 s

Range: -100.0 ms to 500.0 ms

Default Unit: seconds

Front Panel

Access: **Mode Setup, Trigger, Video (IF Envlp), Delay**

## Video (IF) Trigger Level

**:TRIGger[:SEQuence]:IF:LEVel <ampl>**

**:TRIGger[:SEQuence]:IF:LEVel?**

Set the trigger level when using the IF (video) trigger.

Factory Preset: -6.0 dBm for cdmaOne, GSM, EDGE, Basic, Service (E4406A), cdma2000, W-CDMA, 1xEV-DO

–20.0 dBm for iDEN (E4406A)  
–30.0 dBm for NADC, PDC  
Range: –200.0 to 50.0 dBm  
Default Unit: dBm  
Front Panel  
Access: **Mode Setup, Trigger, Video (IF Envlp), Level**

## Video (IF) Trigger Slope

**:TRIGger[:SEQuence]:IF:SLOPe NEGative | POSitive**

**:TRIGger[:SEQuence]:IF:SLOPe?**

Sets the trigger slope when using the IF (video) trigger, to either NEGative or POSitive.

Factory Preset: Positive

Front Panel

Access: **Mode Setup, Trigger, Video (IF Envlp), Slope**

## RF Burst Trigger Delay

**:TRIGger[:SEQuence]:RFBurst:DELay <time>**

**:TRIGger[:SEQuence]:RFBurst:DELay?**

Set the trigger delay when using the RF burst (wideband) trigger.

Factory Preset: 0.0  $\mu$ s

Range: –100.0 ms to 500.0 ms

Default Unit: seconds

Front Panel

Access: **Mode Setup, Trigger, RF Burst, Delay**

## RF Burst Trigger Level

**:TRIGger[:SEQuence]:RFBurst:LEVel <rel\_power>**

**:TRIGger[:SEQuence]:RFBurst:LEVel?**

Set the trigger level when using the RF Burst (wideband) Trigger. The value is relative to the peak of the signal. RF Burst is also known as RF Envelope.

Factory Preset: -6.0 dB

Range: -25.0 to 0.0 dB  
-200.0 to 0.0 dB for NADC, PDC

Default Unit: dB

Front Panel

Access: **Mode Setup, Trigger, RF Burst, Peak Level**

## RF Burst Trigger Slope

**:TRIGger[:SEQuence]:RFBurst:SLOPe NEGative | POSitive**

**:TRIGger[:SEQuence]:RFBurst:SLOPe?**

Set the trigger slope when using the RF Burst (wideband) Trigger.

Factory Preset: Positive

Remarks: You must be in the cdmaOne, cdma2000, W-CDMA mode to use this command. Use :INSTrument:SElect to set the mode.

Front Panel

Access: **Mode Setup, Trigger, RF Burst, Slope**

---

## 5 Concepts

This chapter provides details about the GSM and EDGE communications systems, and explains how the various measurements are performed by the instrument. Suggestions for optimizing and troubleshooting your setup are provided, along with a list of related Agilent documents that are referenced for further information.

---

## What are GSM and EDGE?

The Global System for Mobile communication (GSM) digital communications standard defines a voice and data over-air interface between a mobile radio and the system infrastructure. This standard was designed as the basis for a digital cellular radio communications system. A base station control center (BSC) is linked to multiple base transceiver station (BTS) sites which provide the required coverage.

EDGE (Enhanced Data Rates for GSM Evolution) enhances the GSM standard by implementing a new modulation format and filtering designed to provide higher data rates in the same spectrum. EDGE and GSM signals can be transmitted on the same frequency, occupying different timeslots, and both use existing GSM equipment. EDGE has also been adopted as the basis for IS-136HS.

The GSM digital communications standard employs an 8:1 Time Division Multiple Access (TDMA) allowing eight channels to use one carrier frequency simultaneously. The 270.833 kbits/second raw bit rate is modulated on the RF carrier using Gaussian Minimum Shift Keying (GMSK).

The standard includes multiple traffic channels, a control channel, and a cell broadcast channel. The GSM specification defines a channel spacing of 200 kHz.

GSM 900, GSM 450, GSM 480, GSM 850, DCS 1800, and PCS 1900 are GSM-defined frequency bands. The term GSM 900 is used for any GSM or EDGE system operating in the 900 MHz band, which includes P-GSM, E-GSM, and R-GSM. Primary (or standard) GSM 900 band (P-GSM) is the original GSM band. Extended GSM 900 band (E-GSM) includes all the P-GSM band plus an additional 50 channels. Railway GSM 900 band (R-GSM) includes all the E-GSM band plus additional channels.

GSM 450, GSM 480, GSM 700, and GSM 850 are additional GSM-defined frequency bands, that provide additional bandwidth availability.

DCS 1800 is an adaptation of GSM 900, created to allow for smaller cell sizes for higher system capacity. PCS 1900 is intended to be identical to DCS 1800 except for frequency allocation and power levels. The term GSM 1800 is sometimes used for DCS 1800, and the term GSM 1900 is sometimes used for PCS 1900. For specifics on the bands, refer to Table 5-1.

**Table 5-1 EDGE and GSM Band Data**

	<b>P-GSM (GSM 900)</b>	<b>E-GSM (GSM 900)</b>	<b>R-GSM (GSM 900)</b>	<b>DCS 1800 (GSM 1800)</b>	<b>PCS 1900 (GSM 1900)</b>	<b>GSM 450</b>	<b>GSM 480</b>	<b>GSM 700</b>	<b>GSM 850</b>
Uplink (MS Transmit)	890 to 915 MHz	880 to 915 MHz	876 to 915 MHz	1710 to 1785 MHz	1850 to 1910 MHz	450.4 to 457.6 MHz	478.8 to 486 MHz	777 to 792 MHz	824 to 849 MHz
Downlink (BTS Transmit)	935 to 960 MHz	925 to 960 MHz	921 to 960 MHz	1805 to 1880 MHz	1930 to 1990 MHz	460.4 to 467.6 MHz	488.8 to 496 MHz	747 to 762 MHz	869 to 894 MHz
Range (ARFCN)	1 to 124	0 to 124 and 975 to 1023	1 to 124 and 955 to 1023	512 to 885	512 to 810	259 to 293	306 to 340	438 to 511	128 to 251
TX/RX Spacing (Freq.)	45 MHz	45 MHz	45 MHz	95 MHz	80 MHz	45 MHz	45 MHz	30 MHz	45 MHz
TX/RX Spacing (Time)	3 timeslots	3 timeslots	3 timeslots	3 timeslots	3 timeslots	3 timeslots	3 timeslots	3 timeslots	3 timeslots
Modulation Data Rate GMSK (kbits/s) 8PSK (kbits/s):	270.833 812.499	270.833 812.499	270.833 812.499	270.833 812.499	270.833 812.499	270.833 812.499	270.833 812.499	270.833 812.499	270.833 812.499
Frame Period	4.615 ms	4.615 ms	4.615 ms	4.615 ms	4.615 ms	4.615 ms	4.615 ms	4.615 ms	4.615 ms
Timeslot Period	576.9 $\mu$ s	576.9 $\mu$ s	576.9 $\mu$ s	576.9 $\mu$ s	576.9 $\mu$ s	576.9 $\mu$ s	576.9 $\mu$ s	576.9 $\mu$ s	576.9 $\mu$ s
GSM Bit and Symbol Period	3.692 $\mu$ s	3.692 $\mu$ s	3.692 $\mu$ s	3.692 $\mu$ s	3.692 $\mu$ s	3.692 $\mu$ s	3.692 $\mu$ s	3.692 $\mu$ s	3.692 $\mu$ s
EDGE Symbol Period	3.692 $\mu$ s	3.692 $\mu$ s	3.692 $\mu$ s	3.692 $\mu$ s	3.692 $\mu$ s	3.692 $\mu$ s	3.692 $\mu$ s	3.692 $\mu$ s	3.692 $\mu$ s
<b>Modulation GSM EDGE</b>	0.3 GMSK $3\pi/8$ 8PSK	0.3 GMSK $3\pi/8$ 8PSK	0.3 GMSK $3\pi/8$ 8PSK	0.3 GMSK $3\pi/8$ 8PSK	0.3 GMSK $3\pi/8$ 8PSK	0.3 GMSK $3\pi/8$ 8PSK	0.3 GMSK $3\pi/8$ 8PSK	0.3 GMSK $3\pi/8$ 8PSK	0.3 GMSK $3\pi/8$ 8PSK
Channel Spacing	200 kHz	200 kHz	200 kHz	200 kHz	200 kHz	200 kHz	200 kHz	200 kHz	200 kHz
TDMA Mux	8	8	8	8	8	8	8	8	8
Voice Coder Bit Rate	13 kbits/s	13 kbits/s, 5.6 kbits/s	13 kbits/s	13 kbits/s	13 kbits/s	13 kbits/s	13 kbits/s	13 kbits/s	13 kbits/s

**What are GSM and EDGE?**

The framing structure for GSM and EDGE measurements is based on a hierarchical system consisting of timeslots, TDMA frames, multiframes, superframes, and hyperframes. One timeslot consists of 156.25 (157) symbol periods including tail, training sequence, encryption, guard time, and data bits. Eight of these timeslots make up one TDMA frame. Either 26 or 51 TDMA frames make up one multiframe. Frames 13 and 26 in the 26 frame multiframe are dedicated to control channel signaling. For more detail about timeslots see [“Timeslots” on page 513](#).



## Frequently Used Terms

### Mobile Stations and Base Transceiver Stations

The cellular system includes the following:

- Base transceiver stations, referred to as BTS  
(frequency ranges dependent on the standard; refer to Table 5-1 on page 511)
- Mobile stations, referred to as MS  
(frequency ranges dependent on the standard; refer to Table 5-1 on page 511)

### Uplink and Downlink

Uplink is defined as the path from the mobile station to the base transceiver station. Downlink is the path from the base transceiver station to the mobile station.

### ARFCN

An ARFCN is the Absolute Radio Frequency Channel Number used in EDGE and GSM systems. Each RF channel is shared by up to eight mobile stations using Time Division Multiple Access (TDMA). The ARFCN is an integer (in a range dependent on the chosen standard, refer to Table 5-1 on page 511) which designates the carrier frequency.

### Timeslots

EDGE and GSM use Time Division Multiple Access (TDMA) which divides each RF channel into eight individual timeslots, thus allowing eight users to share a single carrier frequency. Users are synchronized to transmit in series, each in their assigned timeslot. A user may only transmit every 4.62 ms during their timeslot which is 577  $\mu$ s long. The eight timeslots are numbered 0 to 7. The 4.62 ms required to cycle through all eight timeslots is called a frame.

In a GSM signal each 577  $\mu$ s timeslot has a length of 156.25 bit periods, which consists of 148 data bits and 8.25 guard bits.

For an EDGE signal each 577  $\mu$ s timeslot has a length of 156.25 symbol periods, which consist of 142 data symbols of 3 bits each, 8.25 guard symbols of 3 bits each, and 6 “tail bit” symbols of 3 bits each, for a total of 426 data bits, 18 “tail bits” and 24.75 guard bits. The same frame length of 4.62 ms is required to cycle through the frame.

In a TDMA system, the shape and timing of each transmitted burst must be controlled carefully to avoid overlapping timeslots.

---

## Transmit Power Measurement Concepts

### Purpose

Transmit Power is the measure of in-channel power for GSM and EDGE systems. Mobile stations and base transceiver stations must transmit enough power, with sufficient modulation accuracy, to maintain a call of acceptable quality without leaking into frequency channels or timeslots allocated for others. GSM and EDGE systems use dynamic power control to ensure that each link is maintained with minimum power. This gives two fundamental benefits: overall system interference is kept to a minimum and, in the case of mobile stations, battery life is maximized.

The Transmit Power measurement determines the average power for an RF signal burst at or above a specified threshold value. The threshold value may be absolute, or relative to the peak value of the signal.

At the base transceiver station, the purpose of the Transmit Power measurement is to determine the power delivered to the antenna system on the radio-frequency channel under test. The Transmit Power measurement verifies the accuracy of the mean transmitted RF carrier power. This can be done across the frequency range and at each power step.

### Measurement Method

The instrument acquires a GSM or EDGE signal in the time domain. The average power level above the threshold is then computed and displayed. This measurement uses the “power-above-threshold” method instead of the “useful part of the burst” method defined in the GSM standards. The measured Transmit Carrier Power will be very nearly the same for these two methods. The power-above-threshold method has the advantages of being faster and allows power measurements to be made at somewhat lower power levels. It also has the advantage of not requiring the carrier to have a valid TSC (Training Sequence Code).

Note that this measurement does not provide a way to specify which timeslot is to be measured. Therefore if multiple timeslots are on, they should all be set at the same power level, or the levels of those timeslots to be excluded need to be kept below the threshold level. If you want to measure Transmit Carrier Power using the GSM specified useful part of the burst method, use the Power vs. Time or EDGE Power vs. Time measurements, which also measure the power ramping of the burst.

---

## GMSK Power vs. Time Measurement Concepts

### Purpose

---

**NOTE**

This measurement is designed for GSM. For EDGE measurements see [“EDGE Power vs. Time Measurement Concepts” on page 530](#)

Power vs. Time (PvT) measures the mean transmit power during the “useful part” of GSM bursts and verifies that the power ramp fits within the defined mask. Power vs. Time also lets you view the rise, fall, and “useful part” of the GSM burst. Using the “Multi-Slot” function, up to eight slots in a frame can be viewed at one time.

GSM is a Time Division Multiple Access (TDMA) scheme with eight time slots, or bursts, per RF channel. If the burst does not occur at exactly the right time, or if the burst is irregular, then other adjacent timeslots can experience interference. Because of this, the industry standards specify a tight mask for the fit of the TDMA burst.

The Power vs. Time measurement provides masks for both BTS (Base Transceiver Station) and MS (mobile station). The timing masks are referenced to the transition from bit 13 to bit 14 of the midamble training sequence. For GMSK measurements, the 0 dB reference is determined by measuring the mean transmitted power during the “useful part” of the burst. You can also define a user configurable limit mask to apply to the measured burst using SCPI commands (refer to the [“GMSK Power vs. Time Measurement Keys” on page 201](#)).

The GSM specifications defines the “useful part” of the normal GSM burst as being the 147 bits centered on the transition from bit 13 to bit 14 (the “T0” time point) of the 26 bit training sequence.

The PvT measurement may also be used to measure GPRS (General Packet Radio Service) signals. See [“Making GPRS PvT measurements” on page 517](#) for details.

### Measurement Method

The instrument acquires a GSM signal in the time domain. The “T0” point and the useful part are computed. If Burst Sync is set to **Training Seq**, a GSM demodulation is performed to find “T0”. If Burst Sync is set to **RF Amp**, an approximation of “T0” will be used without performing a demodulation. The average power in the useful part is then computed and displayed, and the GSM limit mask is applied. A **PASS** annunciator appears in the instrument display when the burst fits within the bounds of the mask.

## Measurement Adjustments

There are five keys that are frequently used to change power vs. time measurement settings. These are the **Timeslot**, **Burst Type**, and **TSC (Std)** keys located in the **Frequency** menu, and the **Trig Source** and **Burst Sync** keys located in the **Meas Setup** menu.

First, press **Trig Source**. The trigger source determines how the analyzer acquires a frame of data. If **Ext Front** or **Ext Rear** is selected an external, known reference in time will be provided for the data acquisition. If **RF Burst** is selected the rising edge of a burst will be used to initiate data acquisition.

Once data is acquired, the time record is interpreted as a sequence of eight slots. When an **Ext Front** or **Ext Rear** trigger source is selected, the trigger is assumed to be positioned near the beginning of the base station's timeslot. However, if the external trigger is more than 25% away from the burst, the analyzer will not identify the burst and will fail to place a mask on it. If the external trigger is too far away from the burst, you can compensate for this by entering a value for the external trigger delay to bring the burst back into the alignment range of the mask. When the external trigger is not coincident in time with the beginning of the base station's timeslot, press **Mode Setup**, then use the **Trigger** key to select the trigger; once the trigger is selected the **Delay** key will allow you to enter a value for trigger delay.

When **Trig Source** is set to **RF Burst**, data acquisition is delayed until the rising edge of an active timeslot burst. The issue of timeslot tolerance will then apply to any subsequent active time bursts within the frame. Thus, the analyzer uses the rising edge of the RF burst to define the beginning of the first timeslot of the data record.

The analyzer does not perform the protocol analysis that is necessary to identify which absolute slot number a frame is triggering on. If it is necessary to position the measurement on an absolute slot within the GSM frame, an external trigger must be used. As an alternative, a burst of interest can be identified by placing a unique training sequence in it, and setting **TSC (Std)** to manual; this requires that you are able to configure the burst to contain a specified training sequence.

When **Burst Sync** is set to **Training Seq** the analyzer demodulates the burst to identify the training sequence and bit timing, so it can accurately position the limit mask according to the standard. In this case, the **Burst Type** setting (the choices are **Normal**, **Sync**, and **Access**) tells the analyzer demodulation algorithm which burst bit structure should be used.

If **Burst Sync** is set to **RF Amptd**, demodulation is not used and the analyzer then positions the mask in relation to the rising edge of the RF burst.

The timeslot feature is an offset feature that is used to select the “burst of interest”. The “burst of interest” represents the portion of the acquired data record that receives analysis for interpretation as a valid burst; this is the burst to which a limit mask is applied and for which power calculations are generated. When the multi-slot view is selected, all slots in the view are tested for application of the limit mask, but the burst of interest is the one that will be indicated in blue text in the multi-slot table.

For example, if **Timeslot** is set to **On** and 3 is selected, the burst of interest will be offset by 3 slots from the beginning of the acquired time record, and the limit mask will be applied to this burst. If the selected timeslot attempts to locate a burst of interest where no burst is active, the mask application will fail. Timeslot functions as a time pointer offset in the acquired data record, regardless of the **Trig Source** setting.

Once determined, the burst of interest will be demodulated if **Burst Sync** is set to **Training Seq**. **TSC (Std)** applies only when **Burst Sync** is set to **Training Seq**.

When **TSC (Std)** is set to manual, demodulation will search for that specific training sequence number. If it is not found, a limit mask will not be applied, and an error will be reported. When **TSC (Std)** is set to **Auto**, demodulation will search the burst of interest for any of the eight standard training sequences, and use it for to find the true center of the burst so the mask can be applied accurately.

### **Making GPRS PvT measurements**

You can make PvT measurements of GPRS signals if you have at least one inactive slot. The inactive slot is necessary to allow synchronization of multi-slot bursts. Refer to the next section, “Making Multi-Slot Measurements, to configure the measurement timeslots. See [“GPRS Power vs. Time Result - Multi-Slot View \(2 slots shown\)”](#) on page 97 for an example of a GPRS PvT result.

### **Making Multi-Slot Measurements**

First set **Meas Time** to the number of slots you want to view, then activate the **Multi-Slot** view, which is found in the **View/Trace** menu.

You can use the following method to ensure that timeslots 0 - 7 in the transmitted frame correlate with timeslots 0 - 7 as viewed in the transmitter tester:

- Use an external trigger. The Agilent ESG signal generator series, for example, has an “event 1” rear panel output which triggers at the beginning of the frame. Connect the trigger from the signal generator to an external trigger input connector on the transmitter tester, then select the appropriate connector using the **Trigger Source** key in the **Meas Setup** menu.

### Selecting the Burst of Interest

The burst of interest is indicated in blue text in the table shown below the multi slot view. Press the **Burst** view key to view the burst of interest.

- If a timeslot contains a burst with a standard training sequence that is unique to the frame, the specified training sequence can be used to select the timeslot in which the burst of interest occurs. Set **Trigger** to **RF Burst**, set **Burst Sync** to **Training Seq**, and in the **Freq/Chan** menu set **Timeslot** to **OFF**. Then set **TSC (Std)** to **Man** (manual) and enter the training sequence number.
- If only one timeslot in a given frame contains a burst with a standard training sequence, then the specified training sequence can be used to select the timeslot in which the burst of interest occurs. Set **Trigger** to **RF Burst**, **Burst Sync** to **Training Seq**, and in the **Freq/Chan** menu set **Timeslot** **OFF**. Then set **TSC (Std)** to **Auto** and the trigger will automatically search through the available standards for a matching training sequence number.

### Changing the View

The **View/Trace** key accesses a menu that allows you to select the desired view of the measurement from the following selections:

- **Burst** - views the entire burst of interest as determined by the current trigger source, burst sync, training sequence, and timeslot settings. To view a different burst of interest you must set these parameters for the selected timeslot. To view multiple slots use the **Multi-Slot** key described below. See [Figure 2-39 on page 96](#)
- **Rise & Fall** - zooms in on the rising and falling portions of the burst being tested. See [Figure 2-38 on page 96](#).

---

#### NOTE

The limit test will still be performed on the entire burst (viewed using the **Burst** menu) when **Rise & Fall** is selected.

- **Multi-Slot** - views the entire sweep as specified by the current **Meas Time** setting. Power levels for each active slot are listed in a table

below the timeslot display. Also shown in the table under **1st Error Pt.** is the point in time at which the signal level first exceeds the limit; this will help identify the slot where a failure first occurs.

Use the **Meas Time** key located in the **Meas Setup** menu to select up to eight slots. Use the **Timeslot** and **TSC** keys in the **Frequency/Channel** menu to select the slot you wish to activate. Setting **Timeslot** to **ON** and selecting a specific slot results in activating a measurement of that slot only (**Timeslot On** can be used to isolate a failure to a specific slot). When **Timeslot** is set to **OFF**, all active slots are tested against the mask.

Using a signal generator you can synchronize the multi-slot view so the frame (or portion of the frame) you are viewing starts with the slot you have selected. See [“Making Multi-Slot Measurements” on page 517](#).

You can switch from the multi-slot view directly to the burst or rise and fall views of the slot that is currently active. The **Scale/Div** key under the **Span/Y Scale** menu can be used to enlarge your view of this signal.

## Changing the Display

The **Display** key will allow you to turn the limit mask on and off. This also disables the mask limit test, but still calculates the power in the useful part.

## Measurement Results

The views available under the **View/Trace** menu are **Burst**, **Rise & Fall**, and **Multi-Slot**. See [“Changing the View” on page 531](#).

Information shown in the left margin of the displays include:

- **MaxP** - This is total input power allowed for the measurement. This value is coupled to the internal **RF Input Atten** setting.
- **ExtAt** - This value reflects the **External RF Atten** setting.
- **Sync** - The **Burst Sync** setting used in the current measurement
- **Trig** - The **Trigger Source** setting used in the current measurement

The **Mean Transmit Power** is displayed at the bottom left of the **Burst** and **Rise & Fall** views:

- **Mean Transmit Power** - This is the RMS average power across the “useful” part of the burst, or the 147 bits centered on the transition from bit 13 to bit 14 (the “T0” time point) of the 26 bit training sequence. An RMS calculation is performed and displayed regardless of the averaging mode selected for the trace data.

If Averaging = ON, the result displayed is the RMS average power of all bursts measured. If Averaging = OFF, the result is the RMS average power of the single burst measured. This is a different measurement result from Mean Transmit Pwr, below.

The **Current Data** displayed at the bottom of the Burst and Rise & Fall views include:

- **Mean Transmit Pwr** - This result appears only if Averaging = ON. It is the RMS average of power across the “useful” part of the burst, for the current burst only. If a single measurement of “n” averages has been completed, the result will indicate the Mean Transmit Pwr of the last burst. The RMS calculation is performed and displayed regardless of the averaging mode selected for the trace data. This is a different measurement result from Mean Transmit Power, above.
- **Max Pt.** - Maximum signal power point in dBm
- **Min Pt.** - Minimum signal power point in dBm
- **Burst Width** - Time duration of burst at -3 dB power point (half-power)
- **Mask Ref Pwr Midamble** - The Mask Reference Power is the average power in dBm of the middle 16 symbols in the midamble. The times displayed are the corresponding start and stop times of the middle 16 symbols.
- **1st Error Pt** - (Error Point) The time (displayed in ms or  $\mu$ s) indicates the point on the X Scale where the first failure of a signal was detected. Use a marker to locate this point in order to examine the nature of the failure.

The table in the lower portion of the multi-slot view shows the output power in dBm for each timeslot, as determined by the integer (1 to 8) entered in the **Meas Setup, Meas Time** setting. Output power levels are presented for the active slots; a dashed line will appear for any slot that is inactive. The timeslot that contains the burst of interest is highlighted in blue.



---

## GMSK Phase and Frequency Error Measurement Concepts

---

**NOTE** This measurement is designed for GSM only.

### Purpose

Phase and frequency error are the measures of modulation quality for GSM systems. Since GSM systems use relative phase to transmit information, the phase and frequency accuracy of the transmitter are critical to the systems' performance and ultimately affect range.

GSM receivers rely on the phase and frequency quality of the 0.3 GMSK signal in order to achieve the expected carrier to noise performance. A transmitter with high phase and frequency error will often still be able to support phone calls during a functional test. However, it will tend to provide difficulty for mobiles trying to maintain service at the edges of the cell, with low signal levels or under difficult fading and Doppler conditions.

### Measurement Method

The phase error of the test signal is measured by computing the difference between the phase of the transmitted signal and the phase of a theoretically perfect signal.

The instrument samples the transmitter output in order to capture the actual phase trajectory. This is then demodulated and the ideal phase trajectory is mathematically derived. Subtracting one from the other results in an error signal.

This measurement allows you to display these errors numerically and graphically on the analyzer display. It also allows you to view a binary representation of the demodulated data bits.

### Measurement Adjustments

---

**NOTE** The factory default settings provide a GSM compliant measurement. For special requirements, you may need to change some of the settings. Press **Meas Setup, More (1 of 2), Restore Meas Defaults** at any time to return all parameters for the current measurement to their default settings.

Select the desired ARFCN, center frequency, timeslot, burst type, and TSC (Training Sequence Code) as described in the section titled "[FREQUENCY Channel Key Menu](#)" on page 139.

Select the type of carrier to measure. Press **Mode Setup**, **Radio**, **Carrier** and select **Burst** to measure a burst carrier, or **Cont** to measure a continuous carrier from a non-bursting base station.

When **Training Sequence** is selected as the burst sync for this measurement, the **Timeslot** selection to determine which timeslot to measure. For example, if **Timeslot** is set to 2, the measurement will be made on the timeslot number 2. Be careful when adding delay in the Trigger setup, as this measurement does not take into account trigger delay when checking for a valid burst. If there is sufficient delay added (usually more than 25% of a timeslot), the burst might not be detected.

You can make measurements of continuous GMSK signals by synchronizing the measurement to the training sequence. When using the training sequence as the burst sync, the entire data record will be demodulated, and the measurement will search for a training sequence. To select a specific training sequence press **Frequency**, **TSC (Std)** to toggle from **AUTO** to any of 8 standard sequences numbered from 0 to 7.

You can also make continuous carrier measurements without synchronization. Set **Burst Sync** to **RF Amplitd** in the **Meas Setup** menu. The measurement will begin demodulation without searching for a sync word.

Press **Measure**, **Phase & Freq** to immediately make Phase and Frequency Error the active measurement.

To change any of the measurement parameters from the factory default values, refer to the “[GMSK Phase and Frequency Error Measurement Keys](#)” on page 195 for this measurement.

### Changing the View

The **View/Trace** key will allow you to select the desired view of the measurement from the following:

- **I/Q Error (Quad-View)** - Provides a combination view including
  - Window 1: Phase Error
  - Window 2: Phase Error with Freq
  - Window 3: RF Envelope
  - Window 4: Numeric Results and demodulated bits

Any of these windows can be selected (using the **Next Window** key) and made full size (using the **Zoom** key).
- **I/Q Measured Polar Vector** - Provides a view of numeric results and a polar vector graph.
  - Window 1: Numeric Results
  - Window 2: Polar Vector Graph

- **Data Bits** - Provides a view of the numeric results and data bits with the sync word (TSC) highlighted.

The menus under the **Span X Scale** and **Amplitude Y Scale** keys are context dependent upon the selected window (graph type). The **Span X Scale** parameters will be in units of time or bits, dependent on the view selected. The **Amplitude Y Scale** parameters will be in units of dB or degrees, dependent on the view selected. All of the softkey labels are blank when **I/Q Measured Polar Vector**, or **Data Bits** are selected.

### Changing the Display

The **Display** key will allow you to turn the bit dots on and off.

---

## GMSK Output RF Spectrum Measurement Concepts

### Purpose

---

**NOTE** This measurement is designed for GSM. For EDGE Output RF Spectrum measurements see [“EDGE Output RF Spectrum Measurement Concepts”](#) on page 537.

---

The Output RF Spectrum measurement is the GSM version of the adjacent channel power (ACP) measurement. Either a single offset is measured with corresponding traces or up to 15 offsets are measured and a table is displayed. In spectrum due to modulation measurements a sweep spectrum display of -1.8 MHz to +1.8 MHz from the carrier can be viewed.

The output RF spectrum measurements determine the spectral energy emitted into the adjacent channels. Excessive amounts of energy spilling into an adjacent frequency channel could interfere with signals being transmitted to other MS or BTS. The measurements are divided into two main groups: spectrum due to the 0.3 GMSK modulation and noise, and spectrum due to switching transients (burst ramping).

Since GSM is a TDMA format, RF power is being switched on and off depending on whether the actual burst is being transmitted. The switching of power causes spectral splatter at frequencies other than that being transmitted by the carrier. Fast transitions in the time domain causes switching transients that have high frequency content associated with them.

---

**NOTE** The default output RF spectrum measurements do not perform tests at frequency offsets greater than 1800 kHz from the carrier.

---

### Measurement Method

In this measurement, the transmitter (source) is set to transmit a GSM frame at a given channel (frequency). The instrument acquires a time record at a particular offset from the channel being transmitted. The method of acquiring the time record is either a FFT/Inverse-FFT method, or a direct time domain (DTD) method, depending on the offset. These two methods and when they are used, will be described below. When the offset is zero, the instrument is said to be measuring the carrier. For a given offset frequency from the carrier, the transmitter must not exceed a certain power level relative to the carrier. The GSM specification defines the offsets and their maximum absolute and relative power levels.

The general steps in making the measurement are as follows:

- Acquire time record (using either FFT or DTD methods, described below)
- Synchronize for gating on the carrier - finds 50% and 90% portion of burst for Spectrum Due to Modulation portion of the test
- Measure power of the carrier
- Compare each offset power to reference to get relative power level

The method of acquiring the time record is dependent on accuracy and dynamic range. With no pre-ADC filter (infinite bandwidth), the entire IF bandwidth of the IF signal is hitting the analog to digital converter (ADC). The ADC gain is set based on the peak level at its input. The dynamic range (noise floor) of the ADC is dependent on the gain selected. For the type of signals being measured, the highest energy within the IF bandwidth is at the carrier. Therefore, the lowest dynamic range (highest noise floor) of the ADC occurs when the full energy of the carrier is input to the ADC.

All offsets measured using the FFT method are done with the instrument tuned such that the carrier is at the center of the IF bandwidth. Therefore, the dynamic range of the offsets measured using the FFT method is the same as that for the carrier. The dynamic range requirement generally increases as the offset frequency increases. If the dynamic range requirement exceeds what is available by FFT method, the direct time domain (DTD) method utilizing the pre-ADC filter is used.

The **Direct Time Break Freq** key setting is the first offset frequency which is measured using the DTD method. Its range is determined by assuring no aliasing occurs on FFT offsets and that the dynamic range requirements are met.

The FFT method acquires a wideband signal (1.55 MHz) in a flattop filter. An FFT is performed to get the spectrum of the GSM signal. The resolution bandwidth filter can now be applied mathematically to the spectrum at multiple offsets, with an inverse-FFT performed on the data which passes the filter. In this way, multiple offsets are acquired from one time record and LO setting. Since the resolution bandwidth filter is a mathematical formula, it can be any shape and size, and is perfect. The measurement uses the 5-pole synchronously tuned filter that the GSM standard specifies.

The primary disadvantage to the FFT method is that the acquisition must include the carrier. The high energy of the carrier causes the ADC to range down, thus lowering the dynamic range. At large offsets, the dynamic range requirement is very challenging so the direct time domain (DTD) method is used. The LO is tuned to the particular offset and the pre-ADC filter is used to reduce the carrier. This allows the

ADC to range up, giving higher dynamic range. The disadvantage to this method is that each offset measured has its own time record acquisition and LO tune position, and this causes the measurement to slow down compared to FFT offsets. The 5-pole synchronously tuned filter is approximated by utilizing a digital Gaussian filter and setting its equivalent noise bandwidth to that of the 5-pole synchronously tuned filter. For these DTD offset frequencies, the filter has closer-to-ideal 5-pole behavior (< 1% tolerance) than does a 10% tolerance, 5-pole analog filter.

Regardless of how the time record is obtained for a particular offset, the power must be measured and compared to the reference power. There are two measurements being made for the test: output RF spectrum due to modulation and the output RF spectrum due to switching transients. The GSM standard specifies which offsets get which tests. In these two modes, the following conditions are met:

- In the output RF spectrum due to modulation measurement, the average value during at least 40 bits between bit 87 and 132 (approximately equivalent to the 50% to 90% portion of the burst, excluding midamble) is retained. The vertical lines mark the section of the burst over which the measurement is made. If multiple bursts are examined, an average of the average values is calculated. The relative power (difference between the average power of the burst at zero offset and the average power of the burst at the indicated offset) and the absolute power are displayed.
- In the output RF spectrum due to switching transients, the peak value of the whole frame is retained. The reference power of reference due to switching is the average power of the useful part of the burst with at least 300 kHz RBW. The relative power (difference between the mean transmit power of the burst at zero offset and the peak power of the burst at the indicated offset) and the absolute power are displayed.

The GSM standard specifies the tests are run on specified offsets from the carrier. The instrument identifies this as single offset or multiple offset modes. The measurement made in these two modes is the same, except that the multiple offset mode automatically makes the measurement at all the specified offsets frequencies and lists the results in a table at the end of the measurement.

In the output RF spectrum due to modulation measurement, setting the modulation method to discrete obtains results from specified offsets from the carrier as defined in the standard; the results are displayed in a table. When set to sweep, the measurement obtains results of a span extending to 1800 kHz from both sides of the carrier, measured in 10 kHz steps; the results are displayed as a spectrum.

The GMSK ORFS Modulation result view shows a single-offset (Examine) trace for an entire GSM slot. The vertical bars show the portion used to measure power due to modulation.

The RF envelope trace is displayed. If averaging is turned on, the trace is then averaged with previous traces. For the modulation measurement, the user may select the type of trace averaging, either log-power averaged (Video) or power averaged (RMS). For the switching transients measurement, the peak of the traces is used. For modulation, the displayed value is the average of points within the vertical bars. For transients, the displayed value is the max of all points for all traces (Max of Peak) over the entire frame.

## Changing the View

If the Multi-Offset measurement has been chosen and the Meas Type is Mod & Switch, pressing the **View/Trace** key will allow you to select the desired view of the current measurement. If the Meas Type is Modulation, the **Switching Margin and Limit** view is unavailable. If the Meas Type is Switching, the **Modulation Margin & Limit** view is unavailable.

## GMSK Tx Band Spur Measurement Concepts

### Purpose

**NOTE** This measurement is designed for GSM. For EDGE Tx Band Spur measurements see “EDGE Tx Band Spur Measurement Concepts” on page 542.

The Tx Band Spur measurement checks that the transmitter does not transmit undesirable energy into the transmit band. This energy may cause interference for other users of the GSM system.

### Measurement Method

This is a base station only measurement. The transmitter should be set at its maximum output power on all time slots. This measurement is performed at RF channels B (bottom), M (middle), and T (top). Refer to the following table.

Band	Tx Band Edge (MHz)		BOTTOM		MIDDLE		TOP	
	Low	High	Freq (MHz)	ARFC N	Freq (MHz)	ARFC N	Freq (MHz)	ARFC N
P-GSM	935	960	935.20 0	1	947.60 0	63	959.80 0	124
E-GSM	925	960	925.20 0	975	942.60 0	38	959.80 0	124
R-GSM	921	960	921.20 0	955	940.60 0	28	959.80 0	124
DCS 1800	1805	1880	1805.2 0	512	1842.6 0	699	1879.8 0	885
PCS 1900	1930	1990	1930.2 0	512	1960.0 0	661	1989.8 0	810

The transmit band spectrum is measured in several frequency segments using resolution bandwidths as specified by the standard (see the list below).



**Table 5-2**

Frequency Offset	Resolution Bandwidth
≥ 1.8 MHz and < 6 MHz and inside Tx band	30 kHz
≥ 6 MHz and inside Tx band	100 kHz

The mean transmit power is measured first using the “power-above-threshold” method (see the Transmit Power measurement for detail), and then used as a reference for the measurement limit lines if limits are used. The spectrums, which are below or above the carrier frequency and within the transmit band, are measured.

For each spectrum segment, the measurement looks for the spectrum peak closest to the limit and saves the data. The peak of all segments is reported as the *Worst Spur*. The amplitude difference from the peak to the limit line ( $\Delta$  from Limit), and from the peak to the mean transmit power ( $\Delta$  from Carrier) are displayed. The frequency difference from the peak to the carrier frequency (Offset Freq) is also displayed. If the peak goes above the limit line, the display will indicate *FAIL*. If the marker is on, the active marker is placed at the peak of the displayed segment.

### Changing the View

The **View/Trace** key will allow you to further examine the desired spectrum segment. Each of these choices selects a different part of the frequency spectrum for viewing:

**Table 5-3**

<b>Lower Segment</b>	lower Tx band edge to -6 MHz offset from the channel frequency
<b>Lower Adj Segment</b>	-6 MHz to -1.8 MHz offset from the channel frequency
<b>Upper Adj Segment</b>	+1.8 MHz to +6 MHz offset from the channel frequency
<b>Upper Segment</b>	+6 MHz offset from the channel frequency to the upper Tx band edge

---

## EDGE Power vs. Time Measurement Concepts

### Purpose

---

**NOTE** This measurement is designed for EDGE. For GSM Power vs. Time measurements see [“GMSK Power vs. Time Measurement Concepts” on page 515.](#)

---

Power vs. Time measures the mean transmit power during the “useful part” of GSM bursts and verifies that the power ramp fits within the defined mask. Power vs. Time also lets you view the rise, fall, and “useful part” of the GSM burst. Using the “Multi-Slot” feature, up to eight slots in a frame can be viewed at one time.

GSM is a Time Division Multiple Access (TDMA) scheme with eight time slots, or bursts, per RF channel. If the burst does not occur at exactly the right time, or if the burst is irregular, then other adjacent timeslots can experience interference. Because of this, the industry standards specify a tight mask for the fit of the TDMA burst.

The Power vs. Time measurement provides masks for both BTS (Base Transceiver Station) and MS (mobile station). The timings are referenced to the transition from bit 13 to bit 14 of the midamble training sequence. For EDGE measurements, the 0 dB reference is determined by measuring the mean transmitted power during the middle 16 symbols of the midamble. You can also define a user configurable limit mask to apply to the measured burst using SCPI commands (refer to [“EDGE Power vs. Time Measurement Keys” on page 173.](#))

The GSM specifications defines the “useful part” of the normal GSM burst as being the 147 bits centered on the transition from bit 13 to bit 14 (the “T0” time point) of the 26 bit training sequence.

### Measurement Method

The instrument acquires an EDGE signal in the time domain. The “T0” point and the useful part are computed. If Burst Sync is set to **Training Seq**, a  $3\pi/8$  8PSK demodulation is performed to find “T0”. If Burst Sync is set to **RF Amptd**, an approximation of “T0” will be used without performing a demodulation. The average power in the useful part is then computed and displayed, and the EDGE limit mask is applied. The measurement displays `Pass` when the burst fits within the bounds of the mask.

## Measurement Adjustments

### Changing the View

The **View/Trace** key accesses a menu that allows you to select the desired view of the measurement from the following selections:

- **Burst** - views the entire burst of interest as determined by the current trigger source, burst sync, training sequence, and timeslot settings. To view a different burst of interest you must set these parameters for the selected timeslot. To view multiple slots use the **Multi-Slot** key described below. See [Figure 2-2, “EDGE Power vs. Time Result - Burst View,”](#)
- **Rise & Fall** - zooms in on the rising and falling portions of the burst being tested. See [Figure 2-3, “EDGE Power vs. Time Result - Rise & Fall View,”](#)

---

#### NOTE

The limit test will still be performed on the entire burst (viewed using the **Burst** menu) when **Rise & Fall** is selected.

---

- **Multi-Slot** - views the entire sweep as specified by the current **Meas Time** setting. Power levels for each active slot are listed in a table below the timeslot display. Also shown in the table under **1st Error Pt.** is the point in time at which the signal level first exceeds the limit; this will help identify the slot where a failure first occurs. See [Figure 2-4, “EDGE Result - Multi-Slot View,”](#)

Use the **Meas Time** key located in the **Meas Setup** menu to select up to eight slots. Use the **Timeslot** and **TSC** keys in the **Frequency/Channel** menu to select the slot you wish to activate. Setting **Timeslot** to **ON** and selecting a specific slot results in activating a measurement of that slot only (**Timeslot On** can be used to isolate a failure to a specific slot). When **Timeslot** is set to **OFF**, all active slots are tested against the mask.

Using a signal generator you can synchronize the multi-slot view so the frame (or portion of the frame) you are viewing starts with the slot you have selected. See [“Making Multi-Slot Measurements” on page 517.](#)

You can switch from the multi-slot view directly to the burst or rise and fall views of the slot that is currently active. The **Scale/Div** key under the **Span/Y Scale** menu can be used to enlarge your view of this signal.

### Changing the Display

The **Display** key will allow you to turn the limit mask on and off. This also disables the mask limit test, but still calculates the power in the useful part.

---

## EDGE EVM Measurement Concepts

### Purpose

EVM (Error Vector Magnitude) is the measure of modulation quality for EDGE. Since EDGE uses  $3\pi/8$  PSK modulation, the transmitter's phase, frequency, and amplitude accuracy are critical to the communications system's performance. EVM also ultimately affects range.

EDGE receivers rely on the quality of the  $3\pi/8$  PSK modulation signal to achieve the expected carrier to noise ratio. A transmitter with high EVM will often still be able to support phone calls during a functional test. However, it will tend to provide difficulty for mobiles trying to maintain service at the edge of the cell with low signal levels or under difficult fading and Doppler conditions.

### Measurement Method

EVM is measured by calculating the difference between the actual EVM of the transmitted signal and the EVM of a theoretical, ideal signal; this theoretical signal is derived mathematically from data sampled from the transmitted signal.

The EVM measurement allows you to view error results numerically and graphically in the instrument display. The graph windows display EVM Phase Error and Mag Error. The text window displays EVM in % rms, % peak at the highest symbol number, and 90% EVM; Mag Error in % rms; Phase Error in degrees; Freq Error in Hz; Droop in dB/symbol (Droop is stated in dB across the 142 symbol burst, it also allows you to view demodulated symbols), I/Q Offset in dB, and T0 Offset in seconds.

### Measurement Adjustments

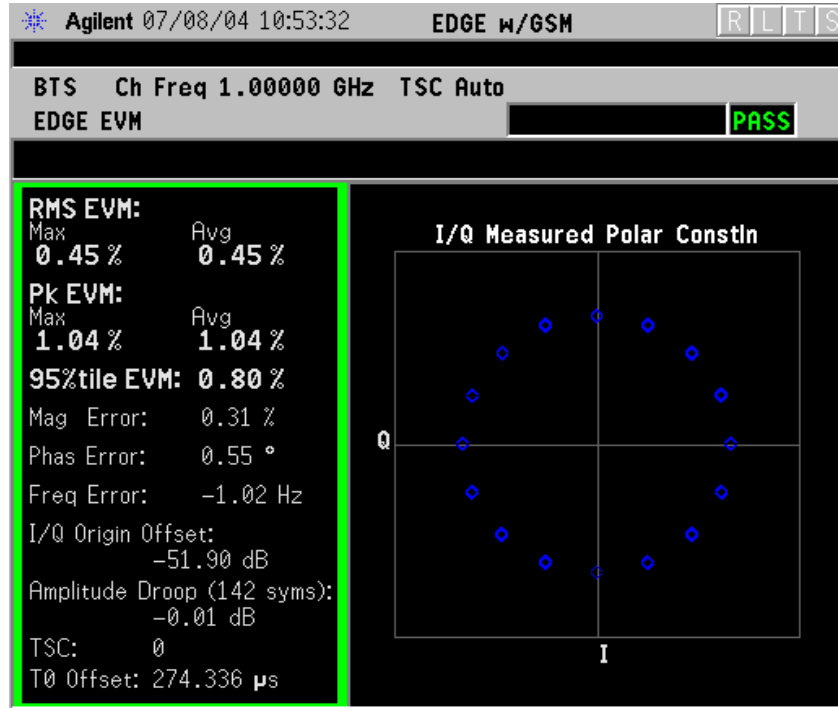
#### Changing the View

The **View/Trace** key accesses the menu which allows you to select the desired measurement view from the following selections:

- **Polar Vector** - The measured summary data is shown in the left window and the dynamic vector trajectory of the I/Q demodulated signal is shown as a vector display in the right window. The polar vector view presents a constantly changing display. See [Figure 2-7, "EDGE EVM Result - Polar Vector View,"](#) for an example.

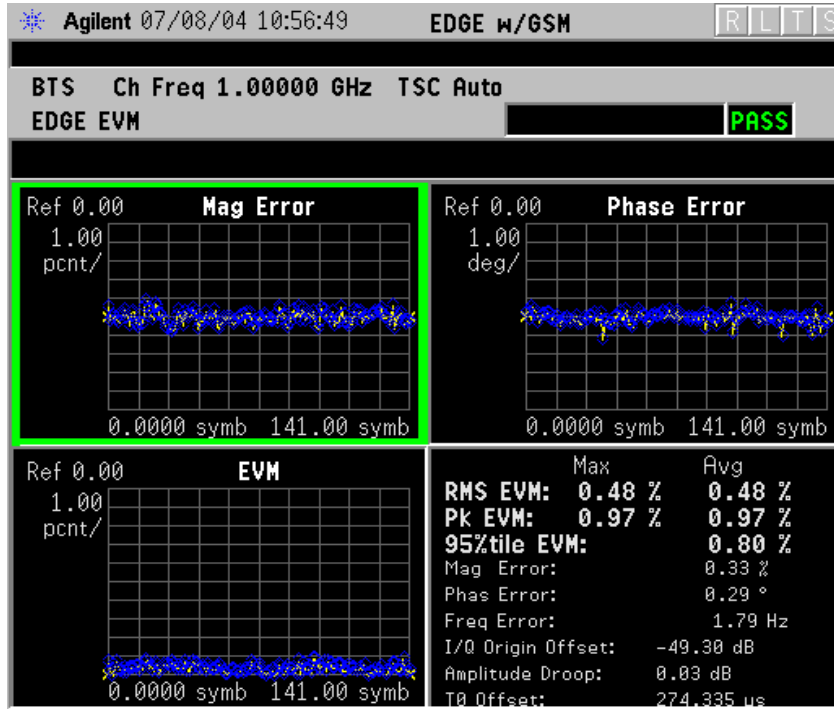
- Polar Constln** - The measured summary data is shown in the left window and the dynamic constellation of the I/Q demodulated signal is shown as a polar display in the right window. See [Figure 5-1 on page 533](#).

**Figure 5-1** EDGE EVM Result- Polar Constln



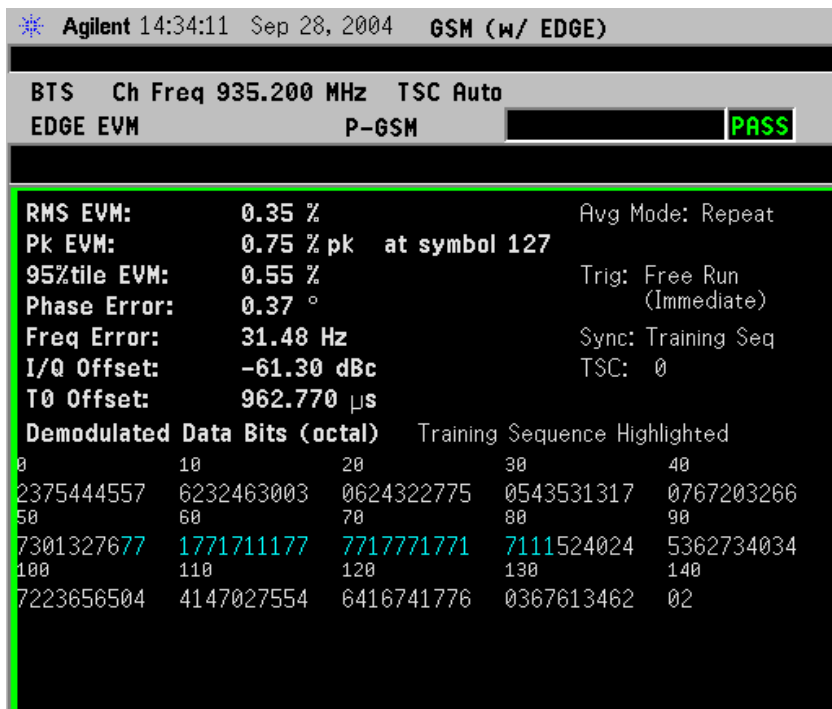
- **I/Q Error (Quad-View)** - Four display windows show EVM, Mag Error and Phase Error graphs, and the EVM summary data text.

**Figure 5-2** EDGE EVM Result - I/Q Error (Quad View)



- **Data Bits** - See [Figure 5-3](#). Provides a view of the numeric results and data bits (in octal) with the sync word (TSC) highlighted.

**Figure 5-3** EDGE EVM Result - Data Bits View



### Changing the Display

The **Display** key accesses the menu to allow the following selections for changing the graph displays:

- **Symbol Dots** - Allows you to toggle the symbol dots between **On** and **Off**. The default setting is **On**.

When either EVM, Phase Error or Mag Error window is active in the I/Q Error (Quad-View) display, the **Span X Scale** key accesses the menu to allow the following selections:

- **Scale/Div** - Allows you to define the horizontal scale by changing the symbol value per division. The range is 1 to 500K symbols per division. The default setting is 14.1 symbols per division for BTS and MS device types.
- **Ref Value** - Allows you to set the symbol reference value ranging from 0 to 500K symbols. The default setting is 0.
- **Ref Position** - Allows you to set the reference position to either **Left**, **Ctr** (center) or **Right**. The default setting is **Left**.
- **Scale Coupling** - Allows you to toggle the scale coupling function between **On** and **Off**. The default setting is **On**. This function

automatically determines the scale per division and reference value by the magnitude of the measurement results.

When EVM, Phase Error, or Mag Error windows are active in the I/Q Error (Quad-View) display, the **Amplitude Y Scale** key accesses a menu which allows the following selections:

- **Scale/Div** - Allows you to define the vertical scale by changing the value per division, with units, ranges, and default values depending on which display window is active.
  - Mag Error Window - Units are in Percent, range is from 0.1% to 50.0%, the default is 1.00%.
  - Phase Error Window - Units are in degrees, range is from 0.01 degrees to 3000 degrees, the default is 1.00 degrees.
  - EVM Window - Units are in Percent, range is from 0.1% to 50.0%, the default is 1.00%

Since the **Scale Coupling** default is set to **On**, the value displayed in this condition is automatically determined by the measurement results.

- **Ref Value** - Allows you to set the reference value, with units, ranges, and default values depending on which display window is active.
  - Mag Error Window - Units are in Percent, range is from -500.0% to 500.0%, the default is 0.00%.
  - Phase Error Window - Units are in degrees, range is from -36000.0 degrees to 36000.0 degrees, the default is 0.00 degrees.
  - EVM Window - Units are in Percent, range is from -500.0% to 500.0%, the default is 0.00%.
- **Ref Position** - Allows you to set the reference position to **Top**, **Ctr** (center) or **Bot** (bottom).
  - Mag Error Window - The default is Ctr.
  - Phase Error Window - The default is Ctr.
  - EVM Window - The default is Top.
- **Scale Coupling** - Allows you to toggle the scale coupling function between **On** and **Off**. The default setting is **On**. This function automatically determines the scale per division and reference value by the magnitude of the measurement results.



---

## EDGE Output RF Spectrum Measurement Concepts

---

**NOTE** This measurement is designed for EDGE. For GSM Output RF Spectrum measurement concepts see [“GMSK Output RF Spectrum Measurement Concepts”](#) on page 524.

---

### Purpose

The Output RF Spectrum measurement is the EDGE version of the adjacent channel power (ACP) measurement. Either a single offset is measured with corresponding traces or up to 15 offsets are measured and a table is displayed. In spectrum due to modulation measurements a sweep spectrum display of  $-1.8$  MHz to  $+1.8$  MHz from the carrier can be viewed.

The output RF spectrum measurements determine the spectral energy emitted into the adjacent channels. Excessive amounts of energy spilling into an adjacent frequency channel could interfere with signals being transmitted to other MS or BTS. The measurements are divided into two main groups: spectrum due to the  $3\pi/8$  8PSK modulation and noise, and spectrum due to switching transients (burst ramping).

Since EDGE is a TDMA format, RF power is being switched on and off depending on whether the actual burst is being transmitted. The switching of power causes spectral splatter at frequencies other than that being transmitted by the carrier. Fast transitions in the time domain causes switching transients that have high frequency content associated with them.

---

**NOTE** The default output RF spectrum measurements do not perform tests at frequency offsets greater than 1800 kHz from the carrier.

---

### Measurement Method

In this measurement, the transmitter (source) is set to transmit an EDGE frame at a given channel (frequency). The instrument acquires a time record at a particular offset from the channel being transmitted. The method of acquiring the time record is either a FFT/Inverse-FFT method, or a direct time domain (DTD) method, depending on the offset. These two methods and when they are used, will be described below. When the offset is zero, the instrument is said to be measuring the carrier. For a given offset frequency from the carrier, the transmitter must not exceed a certain power level relative to the carrier. The EDGE specification defines the offsets and their maximum absolute and relative power levels.

The general steps in making the measurement are as follows:

- Acquire time record (using either FFT or DTD methods, described below)
- Synchronize for gating on the carrier - finds 50% and 90% portion of burst for Spectrum Due to Modulation portion of the test
- Measure power of the carrier
- Compare each offset power to reference to get relative power level

The method of acquiring the time record is dependent on accuracy and dynamic range. With no pre-ADC filter, signals in the entire IF bandwidth of the instrument are digitized by the analog to digital converter (ADC). The setting of the ADC gain is based on the peak level at its input. The dynamic range (noise floor) of the ADC is dependent on the gain selected. For the type of signal being measured, the highest energy within the IF bandwidth is at the carrier. Therefore, the lowest dynamic range (highest noise floor) of the ADC occurs when the full energy of the carrier is input to the ADC.

All offsets measured using the FFT method are done with the instrument tuned such that the carrier is at the center of the IF bandwidth. Therefore, the dynamic range of the offsets measured using the FFT method is the same as that for the carrier. The dynamic range requirement generally increases as the offset frequency increases. If the dynamic range requirement exceeds what is available by FFT method, the direct time domain (DTD) method utilizing the pre-ADC filter is used.

The **Direct Time Break Freq** key setting is the first offset frequency which is measured using the DTD method. Its range is determined by assuring no aliasing occurs on FFT offsets and that the dynamic range requirements are met.

The FFT method acquires a wideband signal (1.55 MHz) in a flattop filter. An FFT is performed to get the spectrum of the GSM signal. The resolution bandwidth filter can now be applied mathematically to the spectrum at multiple offsets, with an inverse-FFT performed on the data which passes the filter. In this way, multiple offsets are acquired from one time record and LO setting. Since the resolution bandwidth filter is a mathematical formula, it can be any shape and size, and is perfect. The transmitter tester uses the 5-pole synchronously tuned filter that is specified by the GSM standard.

The primary disadvantage to the FFT method is that the acquisition must include the carrier. The high energy of the carrier causes the ADC to range down, thus lowering the dynamic range. At large offsets, the dynamic range requirement is very challenging so the direct time domain (DTD) method is used. The LO is tuned to the particular offset and the pre-ADC filter is used to reduce the carrier. This allows the ADC to range up, giving higher dynamic range. The disadvantage to

this method is that each offset measured has its own time record acquisition and LO tune position, and this causes the measurement to slow down compared to FFT offsets. The 5-pole synchronously tuned filter is approximated by utilizing a digital Gaussian filter and setting its equivalent noise bandwidth to that of the 5-pole synchronously tuned filter. For these DTD offset frequencies, the filter has closer-to-ideal 5-pole behavior (< 1% tolerance) than does a 10% tolerance, 5-pole analog filter.

Regardless of how the time record is obtained for a particular offset, the power must be measured and compared to the reference power. There are two measurements being made for the test: output RF spectrum due to modulation and the output RF spectrum due to switching transients. The GSM/EDGE standard specifies which offsets get which tests. In these two modes, the following conditions are met:

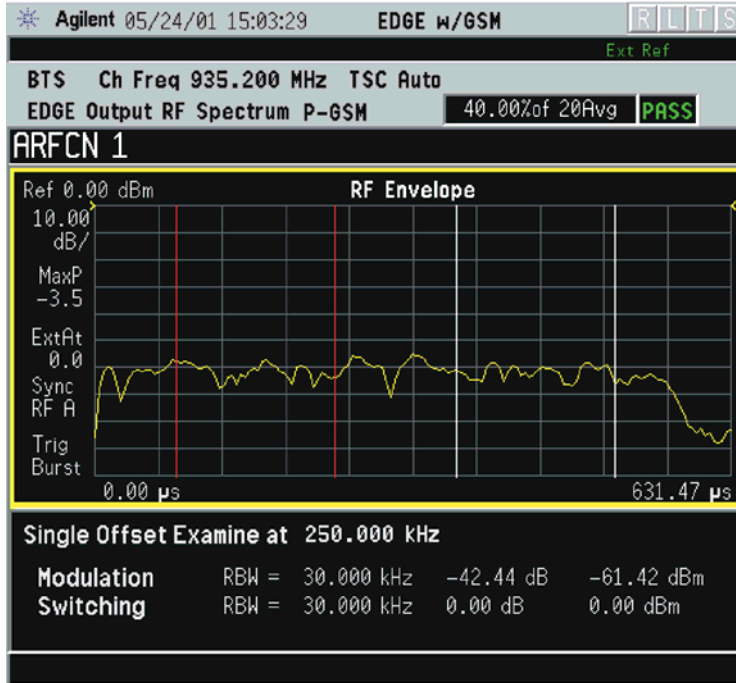
- In the output RF spectrum due to modulation measurement, the average value during at least 40 bits between bit 87 and 132 (approximately equivalent to the 50% to 90% portion of the burst, excluding midamble) is retained. The vertical lines mark the section of the burst over which the measurement is made. If multiple bursts are examined, an average of the average values is calculated. The relative power (difference between the average power of the burst at zero offset and the average power of the burst at the indicated offset) and the absolute power are displayed.
- In the output RF spectrum due to switching transients, the peak value of the whole frame is retained. The reference power of reference due to switching is the average power of the useful part of the burst with at least 300 kHz RBW. The relative power (difference between the mean transmit power of the burst at zero offset and the peak power of the burst at the indicated offset) and the absolute power are displayed.

The GSM/EDGE standard specifies the tests are run on specified offsets from the carrier. The instrument identifies this as single offset or multiple offset modes. The measurement made in these two modes is the same, except that the multiple offset mode automatically makes the measurement at all the specified offsets frequencies and lists the results in a table at the end of the measurement.

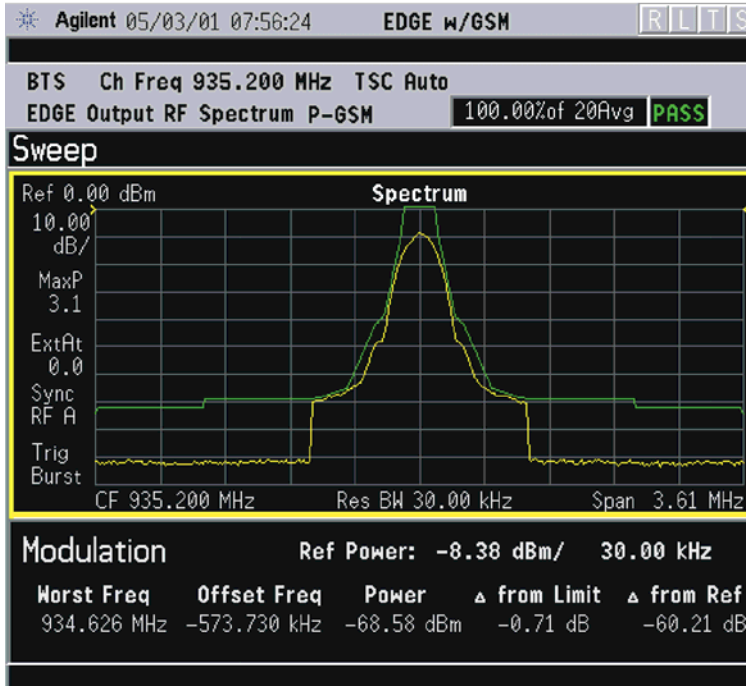
In the output RF spectrum due to modulation measurement, setting the modulation method to discrete obtains results from specified offsets from the carrier as defined in the standard; the results are displayed in a table. When set to sweep, the measurement obtains results of a span extending to 1800 kHz from both sides of the carrier, measured in 10 kHz steps; the results are displayed as a spectrum.

The EDGE ORFS Modulation view shows a single-offset (Examine) trace for an entire EDGE slot. The vertical bars show the portion used to measure power due to modulation.

**Figure 5-4** EDGE ORFS Result - Modulation with Single-Offset (Examine)



**Figure 5-5** EDGE ORFS Result - Modulation Sweep Spectrum



The RF envelope trace is displayed. If averaging is turned on, the trace is then averaged with previous traces. For the modulation measurement, the user may select the type of trace averaging, either log-power averaged (Video) or power averaged (RMS). For the switching

transients measurement, the peak of the traces is used. For modulation, the displayed value is the average of points within the vertical bars. For transients, the displayed value is the max of all points for all traces (Max of Peak) over the entire frame.

## Measurement Adjustments

### Changing the View

If the Multi-Offset measurement has been chosen and the Meas Type is Mod & Switch, pressing the **View/Trace** key will allow you to select the desired view of the current measurement. If the Meas Type is Modulation, the **Switching Margin and Limit** view is unavailable. If the Meas Type is Switching, the **Modulation Margin & Limit** view is unavailable.

## EDGE Tx Band Spur Measurement Concepts

### Purpose

**NOTE** This measurement is designed for EDGE. For GSM Tx Band Spur measurements see “GMSK Tx Band Spur Measurement Concepts” on page 528.

The EDGE Tx Band Spur measurement checks that the transmitter does not transmit undesirable energy into the transmit band. This energy may cause interference for other users of the EDGE and GSM systems.

### Measurement Method

This is a base station only measurement. The transmitter should be set at its maximum output power on all time slots. This measurement is performed at RF channels B (bottom), M (middle), and T (top). Refer to the following table.

Band	Tx Band Edge (MHz)		BOTTOM		MIDDLE		TOP	
	Low	High	Freq (MHz)	ARFC N	Freq (MHz)	ARFC N	Freq (MHz)	ARFC N
P-GSM	935	960	935.20 0	1	947.60 0	63	959.80 0	124
E-GSM	925	960	925.20 0	975	942.60 0	38	959.80 0	124
R-GSM	921	960	921.20 0	955	940.60 0	28	959.80 0	124
DCS 1800	1805	1880	1805.2 0	512	1842.6 0	699	1879.8 0	885
PCS 1900	1930	1990	1930.2 0	512	1960.0 0	661	1989.8 0	810

The transmit band spectrum is measured in several frequency segments using resolution bandwidths as specified by the standard (see the list below).

**Table 5-4**

Frequency Offset	Resolution Bandwidth
≥ 1.8 MHz and < 6 MHz and inside Tx band	30 kHz
≥ 6 MHz and inside Tx band	100 kHz

The mean transmit power is measured first using the “power-above-threshold” method and the threshold is set to -20 dB (see the Transmit Power measurement for detail), and then used as a reference for the measurement limit lines if limits are used. The spectrums, which are below or above the carrier frequency and within the transmit band, are measured.

For each spectrum segment, the measurement looks for the spectrum peak closest to the limit and saves the data. The peak of all segments is reported as the *Worst Spur*. The amplitude difference from the peak to the limit line ( $\Delta$  from Limit), and from the peak to the mean transmit power ( $\Delta$  from Carrier) are displayed. The frequency difference from the peak to the carrier frequency (Offset Freq) is also displayed. If the peak goes above the limit line, the display will indicate *FAIL*. If Marker is on, the active marker is placed at the peak of the displayed segment.

## Measurement Adjustments

### Changing the View

The **View/Trace** key will allow you to further examine the desired spectrum segment. See “[EDGE Tx Band Spur Measurement Keys](#)” on [page 181](#). Each of these choices selects a different part of the frequency spectrum for viewing:

<b>Lower Segment</b>	lower Tx band edge to -6 MHz offset from the channel frequency
<b>Lower Adj Segment</b>	-6 MHz to -1.8 MHz offset from the channel frequency
<b>Upper Adj Segment</b>	+1.8 MHz to +6 MHz offset from the channel frequency
<b>Upper Segment</b>	+6 MHz offset from the channel frequency to the upper Tx band edge

---

## Spectrum (Frequency Domain) Measurement Concepts

### Purpose

The spectrum measurement provides spectrum analysis capability for the instrument. The control of the measurement was designed to be familiar to those who are accustomed to using swept spectrum analyzers.

This measurement is FFT (Fast Fourier Transform) based. The FFT-specific parameters are located in the **Advanced** menu. Also available under basic mode spectrum measurements is an I/Q window, which shows the I and Q signal waveforms in parameters of voltage versus time. The advantage of having an I/Q view available while in the spectrum measurement is that it allows you to view complex components of the same signal without changing settings or measurements.

### Measurement Method

The measurement uses digital signal processing to sample the input signal and convert it to the frequency domain. With the instrument tuned to a fixed center frequency, samples are digitized at a high rate, converted to I and Q components with DSP hardware, and then converted to the frequency domain with FFT software.

For E4406A Option B7C, this measurement is available for both the RF input and baseband I/Q inputs. For details on Baseband I/Q operation see the section on [“Using Option B7C Baseband I/Q Inputs”](#).

### Troubleshooting Hints

Changes made by the user to advanced spectrum settings, particularly to ADC range settings, can inadvertently result in spectrum measurements that are invalid and cause error messages to appear. Care needs to be taken when using advanced features.



---

## Waveform (Time Domain) Measurement Concepts

### Purpose

The waveform measurement is a generic measurement for viewing the input signal waveforms in the time domain. This measurement is how the instrument performs the zero span functionality found in traditional spectrum analyzers.

Basic mode waveform measurement data may be displayed using either a Signal Envelope window, or an I/Q window which shows the I and Q signal waveforms in parameters of voltage versus time. The advantage of having an I/Q view available while making a waveform measurement is that it allows you to view complex components of the same signal without changing settings or measurements.

The waveform measurement can be used to perform general purpose power measurements in the time domain with excellent accuracy.

### Measurement Method

The instrument makes repeated power measurements at a set frequency, similar to the way a swept-tuned spectrum analyzer makes zero span measurements. The input analog signal is converted to a digital signal, which then is processed into a representation of a waveform measurement. The measurement relies on a high rate of sampling to create an accurate representation of a time domain signal.

For E4406A with Option B7C, this measurement is available for use with both the RF input and baseband I/Q inputs. For details on Baseband I/Q operation see the section on “Using Option B7C Baseband I/Q Inputs”.

---

## Baseband I/Q Inputs (Option B7C ) Measurement Concepts

The E4406A VSA Option B7C Baseband I/Q Inputs provides the ability to analyze baseband I/Q signal characteristics of mobile and base station transmitters. This option may be used only in conjunction with the following personalities:

- Basic mode (available in all VSA Series Transmitter Testers)
- Option BAF W-CDMA Measurement Personality
- Option B78 cdma2000 Measurement Personality
- Option 202 GSM with EDGE
- Option 252 GSM to GSM with EDGE upgrade

### What are Baseband I/Q Inputs?

Option B7C consists of a Baseband Input module, four 50  $\Omega$  BNC connectors, and internal cabling. The four BNC connectors are grouped into pairs at the upper left corner of the front panel. The upper two connectors labeled “I” and “Q” are the “unbalanced” inputs.

In practice, an unbalanced or “single-ended” baseband measurement of an I or Q signal is made using a probe connected to the I or Q connector. A simultaneous I/Q unbalanced single-ended measurement may be made using two probes connected to the I and Q input connectors.

If “balanced” signals are available, they may be used to make a more accurate measurement. Balanced signals are signals present in two separate conductors, are symmetrical about ground, and are opposite in polarity, or out of phase by 180 degrees.

Measurements using balanced signals can have a higher signal to noise ratio resulting in improving accuracy. Noise coupled into each conductor equally in a “common mode” to both signals may be separated from the signal. The measure of this separation is “common-mode rejection”.

To make a balanced measurement, the lower two connectors labeled “ $\bar{I}$ ” and “ $\bar{Q}$ ” are used in conjunction with the I and Q inputs. The terms “I-bar” and “Q-bar” may be applied to the signals, as well as the inputs themselves. Probes (customer provided) must be used to input balanced baseband I/Q signals. This may be referred to as a balanced measurement.

Balanced baseband measurements are made using the I and  $\bar{I}$  connectors for I only signal measurements, while the Q and  $\bar{Q}$  connectors are used for a Q only signal measurement. Balanced measurements of I/Q require differential probe connections to all four

input connectors. For details of probe selection and use, refer to “Selecting Input Probes for Baseband Measurements” on page 547.

## What are Baseband I/Q Signals?

In transmitters, the term baseband I/Q refers to signals that are the fundamental products of individual I/Q modulators, before the I and Q component signals are combined, and before upconversion to IF or RF frequencies.

In receivers, baseband I/Q analysis may be used to test the I and Q products of I/Q demodulators, after an RF signal has been downconverted and demodulated.

## Why Make Measurements at Baseband?

Baseband I/Q measurements are a valuable means of making qualitative analyses of the following operating characteristics:

- I/Q signal layer access for performing format-specific demodulation measurements (e.g. CDMA, GSM, W-CDMA):
- Modulation accuracy – i.e. I/Q plane metrics
  - rho
  - error vector magnitude; rms, peak, or 95%
  - carrier feed-through
  - frequency error
  - magnitude and phase errors
- Code-domain analysis (including code-specific metrics)
- CCDF of  $I^2 + Q^2$
- Single sideband (SSB) metrics for assessing output quality
- Basic analysis of I and Q signals in isolation including: DC content, rms and peak to peak levels, CCDF of each channel

Comparisons of measurements made at baseband and RF frequencies produced by the same device are especially revealing. Once signal integrity is verified at baseband, impairments can be traced to specific stages of upconversion, amplification, or filtering by RF analysis. Likewise, impairments to signal quality that are apparent at RF frequencies may be traceable to baseband using baseband analysis.

## Selecting Input Probes for Baseband Measurements

The selection of baseband measurement probe(s) and measurement method is primarily dependent on the location of the measurement

point in the circuit. The probe must sample voltages without imposing an inappropriate load on the circuit.

The following measurement methods may be used with baseband I/Q inputs:

- **50  $\Omega$  Unbalanced** - This is the measurement method of choice if single-ended or unbalanced baseband I and/or Q signals are available in 50  $\Omega$  coaxial transmission lines and are terminated in a coaxial connectors. Adapters necessary to convert to a 50  $\Omega$  BNC-type male connector must be of 50  $\Omega$  impedance.

The methods are as follows:

- I only measurement using one single-ended probe connected to the I input connector (available in the Basic mode)
- Q only measurement using one single-ended probe connected to the Q input connector (available in the Basic mode)
- I/Q measurement using two single-ended probes connected to the I and Q input connectors

- **600  $\Omega$  Balanced** - This is the measurement method of choice if balanced baseband signals having a 600  $\Omega$  impedance are available. The methods are as follows:

- I only measurement using one differential probe or two single-ended probes connected to the I and  $\bar{I}$  inputs (available in the Basic mode)
- Q only measurement using one differential probe or two single-ended probes connected to the Q and  $\bar{Q}$  inputs (available in the Basic mode)
- I/Q measurement using two differential probes or four single-ended probes connected to the I, Q,  $\bar{I}$ , and  $\bar{Q}$  input connectors

- **1 M $\Omega$  Unbalanced** - High input impedance is the measurement method of choice if single-ended or unbalanced baseband signals to be measured lie in a trace on a circuit board and are sensitive to loading by the probe. This is the default input connector setting.

When making 1 M $\Omega$  measurements, the reference input impedance may be adjusted. For details refer to [“I/Q Setup Key Menu” on page 248](#). 1 M $\Omega$  unbalanced measurements may be made as follows:

- I only measurement using one single-ended probe connected to the I input connector (available in the Basic mode)
- Q only measurement using one single-ended probe connected to the Q input connector (available in the Basic mode)
- I/Q measurement using two single-ended probes connected to the

## I and Q input connectors

- **1 M $\Omega$  Balanced** - High input impedance measurements may also be made if differential or balanced signals are available. 1 M $\Omega$  balanced measurements may be made as follows:
  - I only measurement using one differential probe or two single-ended probes connected to the I and  $\bar{I}$  inputs (available in the Basic mode)
  - Q only measurement using one differential probe or two single-ended probes connected to the Q and  $\bar{Q}$  inputs (available in the Basic mode)
  - I/Q measurement using two differential probes or four single-ended probes connected to the I, Q,  $\bar{I}$ , and  $\bar{Q}$  input connectors

This is the measurement method of choice if differential or balanced baseband signals to be measured lie in a trace on a circuit board and are sensitive to loading by the probe. When making 1 M $\Omega$  measurements, the reference input impedance may be adjusted. For details refer to “[I/Q Setup Key Menu](#)” on page 248.

The following table lists the probes currently available from Agilent, which are suitable for use under various measurement conditions:

**Table 5-5 Agilent Probes - Balanced and Unbalanced**

Probe Type	Description
Unbalanced (single-ended)	1144A 800 MHz Active Probe <sup>abc</sup> 54701A 2.5 GHz Active Probe <sup>bcd</sup> 1145A 750 MHz 2-Channel Active Probe <sup>abc</sup> 85024A High Frequency Probe <sup>be</sup> 41800A Active Probe <sup>bf</sup> 10020A Resistive Divider Probe <sup>bc</sup> 54006A 6 GHz Passive Divider Probe <sup>g</sup>
Balanced (differential)	1141A 200 MHz Active Differential Probe <sup>abc</sup> N1025A 1 GHz Active Differential Probe <sup>bh</sup>

- a. Not compatible with 3-wire power interface. Needs 1142A power supply. For two channels, you will need either two 1142A power supplies or one 1142A power supply and one 01144-61604 1-input, two-output adapter cable.
- b. Two probes needed to cover both I and Q inputs.
- c. Output connector is BNC-type.
- d. Not compatible with 3-wire power interface. Requires use of 1143A power supply that can power two 54701A probes.
- e. 85024A bandwidth is 300 kHz to 3 GHz. Output connector is N-type. Power is 3-wire connector (+15 V, -12.6 V, ground).
- f. 41800A bandwidth is 5 Hz to 500 MHz. Output connector is N-type. Power is 3-wire connector (+15 V, -12.6 V, ground).
- g. 54006A output connector is 3.5 mm
- h. 3.5 mm output connector, requires ±15 V supply.

Refer to the current Agilent data sheet for each probe for specific information regarding frequency of operation and power supply requirements.

The E4406A Transmitter Tester provides one “three-wire” probe power connector on the front panel. Typically, it can energize one probe. If you plan on operating more than one probe, make sure you provide sufficient external power sources as required.

### Baseband I/Q Measurement Views

Measurement result views made in the Basic mode, or by other compatible optional personalities, are available for baseband signals if they relate to the nature of the signal itself. Many measurements which relate to the characteristics baseband I and Q signals have when mixed and upconverted to signals in the RF spectrum can be made as well. However, measurements which relate to the characteristics of an

Concepts

upconverted signal that lie beyond the bandwidth available to the Baseband I/Q Input circuits can not be measured (the limits are up to 5 MHz bandwidth for individual I and Q signals, and up to 10 MHz for composite I/Q signals).

Some measurement views are appropriate for use with both RF and baseband I/Q signals without any modification, while other views must be altered. Some examples of measurements with identical results views are QPSK EVM, Code Domain, and CCDF. For Spectrum measurements, identical views include the I and Q Waveform view and the I/Q Polar view. For Waveform measurements, identical views include the I/Q Waveform view, the Signal Envelope view, and the I/Q Polar view.

At RF frequencies, power measurements are conventionally displayed on a logarithmic vertical scale in dBm units, whereas measurements of baseband signals using Baseband I/Q inputs may be conveniently displayed as voltage using a linear vertical scale as well as a log scale.

### **Spectrum Views and 0 Hz Center Frequency**

Some views must be altered to account for the fundamental difference between RF and baseband I/Q signals. For Spectrum measurements of I/Q signals this includes using a center frequency of 0 Hz for Spectrum views and the Spectrum Linear view. Occupied Bandwidth and Channel Power results are also displayed using a center frequency of 0 Hz.

The center frequency of baseband I/Q Spectrum displays is 0 Hz. Frequencies higher than 0 Hz are displayed as “positive” and those below 0 Hz are “negative”. The “negative” portion of a multi-channel baseband signal below 0 Hz corresponds to the portion of the signal that would lie below the carrier center frequency when it is upconverted, if no spectral inversion occurs. As 0 Hz is a fixed center frequency, the **FREQUENCY Channel** front-panel key has no active menu for baseband I/Q Spectrum measurements.

### **Waveform Views for Baseband I/Q Inputs**

For Waveform measurements, two new displays are available exclusively for baseband I/Q input signals; the I and Q Waveform view, which separates the individual I and Q traces, and the I/Q Polar view. Since the horizontal axis for Waveform measurements is Time, the **FREQUENCY Channel** front-panel key has no active menu for baseband I/Q Waveform measurements. Use **Span** to change horizontal scale. A **Linear Envelope** view is also available to display baseband signals that employs linear voltage units on the vertical axis.

### **Waveform Signal Envelope Views of I only or Q only**

To view the Signal Envelope display of I only or Q only signals, use the Waveform measurement capability in Basic Mode.

### Comparing RF and Baseband I/Q Measurement Views

The following table compares the measurement views for RF inputs and baseband I/Q inputs.

**Table 5-6 RF vs. Baseband I/Q Input Measurement Views by Measurement**

Measurement	Views for RF Input Measurements	Views for Baseband I/Q Inputs Measurements	Mods to RF View for Baseband I/Q Inputs
Channel Power	Channel Power	Channel Power	Center Freq = 0 Hz
ACP	FFT, Fast Bar Graph, Spectrum	Measurement Not Available	n/a
Power Stat CCDF	CCDF	CCDF	none
Spectrum (Freq Domain)	Spectrum Spectrum Linear I and Q Waveform I/Q Polar	Spectrum Spectrum Linear I and Q Waveform I/Q Polar	Center Freq = 0 Hz (Spectrum Views) Y axis = V, dBm (Spectrum Linear)
Waveform (Time Domain)	Signal Envelope I/Q Waveform I/Q Polar	Signal Envelope I/Q Waveform I/Q Polar Linear Envelope I and Q Waveform	Y axis = V, dBm (Linear Envelope)

Results screens for the above measurements unique to baseband I/Q inputs are shown in the section [“Baseband I/Q Measurement Result Examples”](#) on page 129.



---

## Other Sources of Measurement Information

Additional measurement application information is available through your local Agilent Technologies sales and service office. The following application notes treat digital communications measurements in much greater detail than discussed in this measurement guide.

- Application Note 1298  
Digital Modulation in Communications Systems - An Introduction  
part number 5965-7160E
- Application Note 1312  
Understanding GSM Transmitter Measurements for Base  
Transceiver Stations and Mobile Stations  
part number 5966-2833E

### Instrument Updates at [www.agilent.com](http://www.agilent.com)

These web locations can be used to access the latest information about the instrument, including the latest firmware version.

<http://www.agilent.com/find/vsa>

<http://www.agilent.com/find/psa>



---

---

# 6

## Menu Maps

These menu maps are in alphabetical order by the front panel key label or oval cross-reference label. You can locate detailed information about each key/function at the page number listed in the figure title for each menu.

---

## EDGE and GSM Measurement Key Flow

The key flow diagrams, shown in a hierarchical manner on the following pages, will help grasp the overall functional relationships for the front-panel keys and the keys displayed at the extreme right side of the screen. The diagrams are:

- “MODE Selection Key Flow” on page 557
- “Mode Setup/FREQUENCY Channel Key Flow (1 of 3)” on page 558
- “Measurement Selection Key Flow” on page 561
- “Transmit Power Measurement Key Flow” on page 562
- “GMSK Power vs. Time Measurement Key Flow” on page 563
- “GMSK Phase & Frequency Error Measurement Key Flow (1 of 2)” on page 564
- “GMSK Output RF Spectrum Measurement Key Flow (1 of 2)” on page 566
- “GMSK Tx Band Spur Measurement Key Flow” on page 568
- “EDGE Power vs. Time Measurement Key Flow” on page 569
- “EDGE EVM Measurement Key Flow (1 of 2)” on page 570
- “EDGE Output RF Spectrum Measurement Key Flow (1 of 2)” on page 572
- “EDGE Tx Band Spur Measurement Key Flow” on page 574
- “Spectrum (Freq Domain) Measurement Key Flow (1 of 3)” on page 575
- “Waveform (Time Domain) Measurement Key Flow (1 of 2)” on page 578

Use these flow diagrams as follows:

- There are some basic conventions:

Meas Setup

An oval represents one of the front-panel keys.

EDGE EVM

This box represents one of the keys displayed.

<for EVM>

This represents an explanatory description on its specific key.

Avg Bursts 20 On|Off

This box shows how the key default condition is displayed. Default parameters or values are underlined wherever possible.

- Start from the upper left corner of each measurement diagram. Go to the right, and go from the top to the bottom.
- When changing a key from auto (with underline) to manual, just

press that key one time.

- When entering a numeric value of **FREQUENCY Channel**, for example, use the numeric keypad and terminate the entry with the appropriate unit selection from the softkeys displayed.
- When entering a numeric value without a unit, like **Avg Number**, use the numeric keypad and terminate the entry with the **Enter** front-panel key.
- Instead of using the numeric keypad to enter a value, it may be easier to use the RPG knob or **Up/Down** keys.

**Figure 6-1** MODE Selection Key Flow

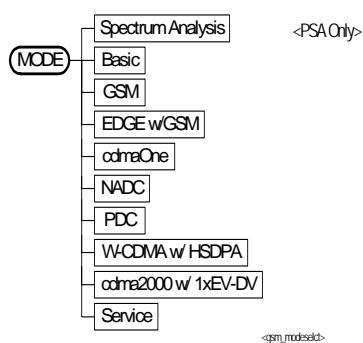


Figure 6-2 Mode Setup/FREQUENCY Channel Key Flow (1 of 3)

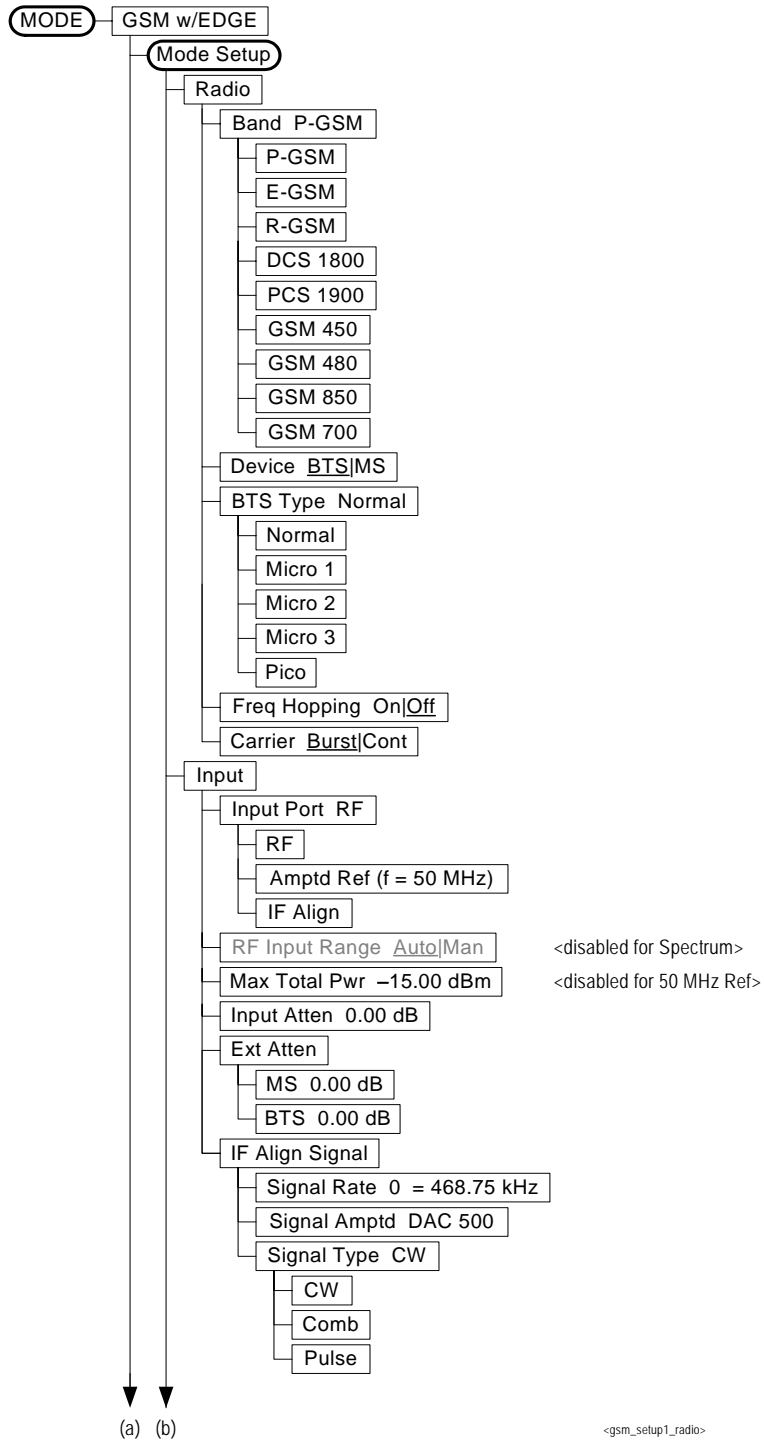


Figure 6-3 Mode Setup/FREQUENCY Channel Key Flow (2 of 3)

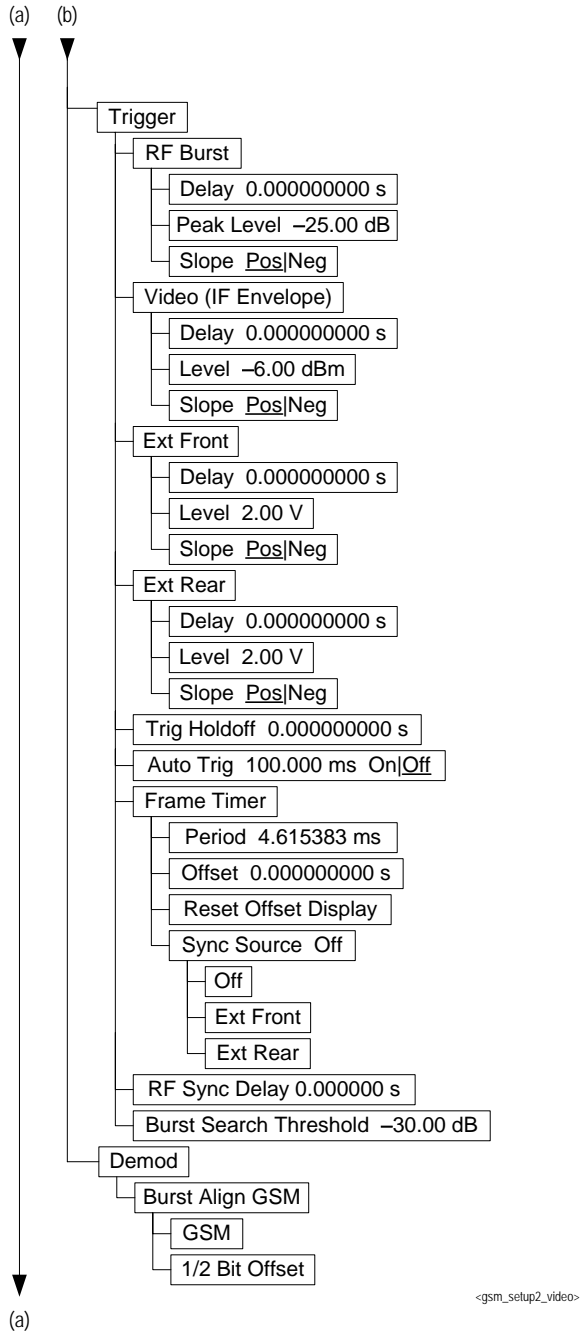


Figure 6-4 Mode Setup/FREQUENCY Channel Key Flow (3 of 3)

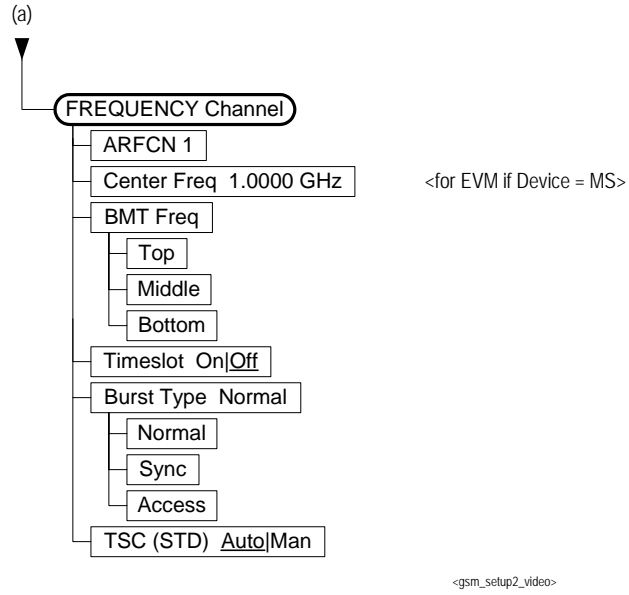




Figure 6-5 Measurement Selection Key Flow

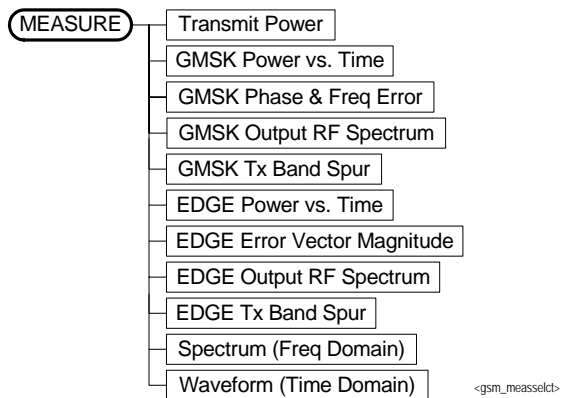


Figure 6-6 Transmit Power Measurement Key Flow

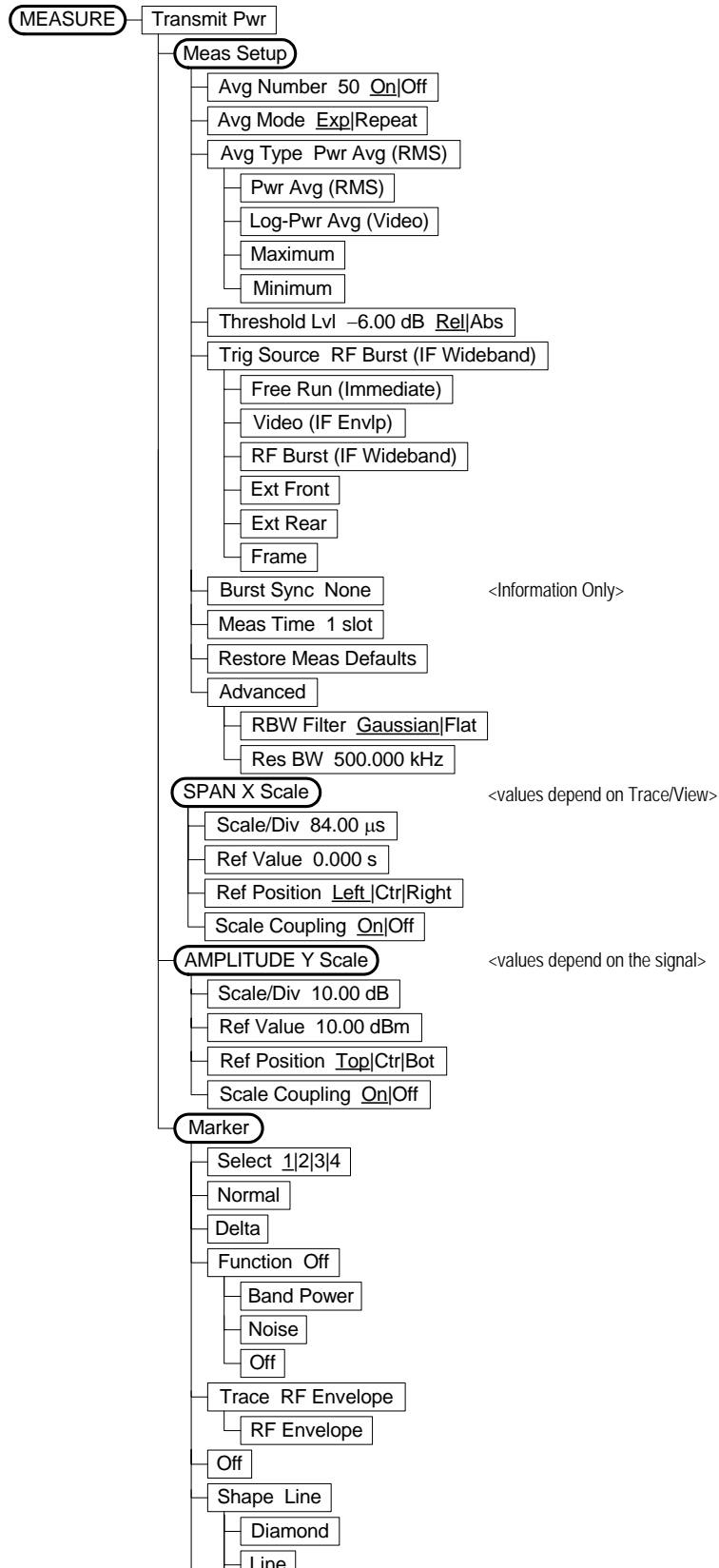


Figure 6-7 **GMSK Power vs. Time Measurement Key Flow**

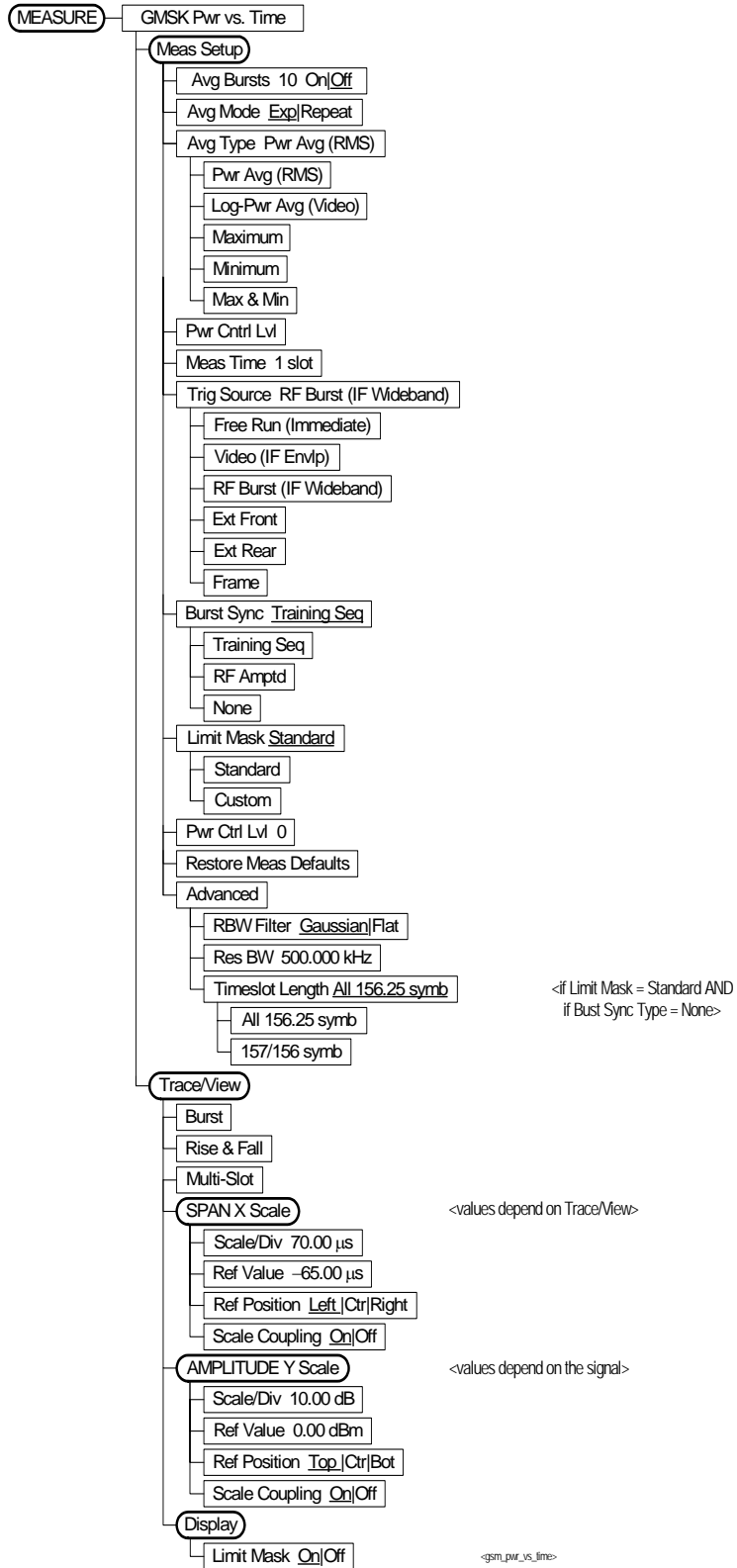


Figure 6-8 GMSK Phase & Frequency Error Measurement Key Flow (1 of 2)

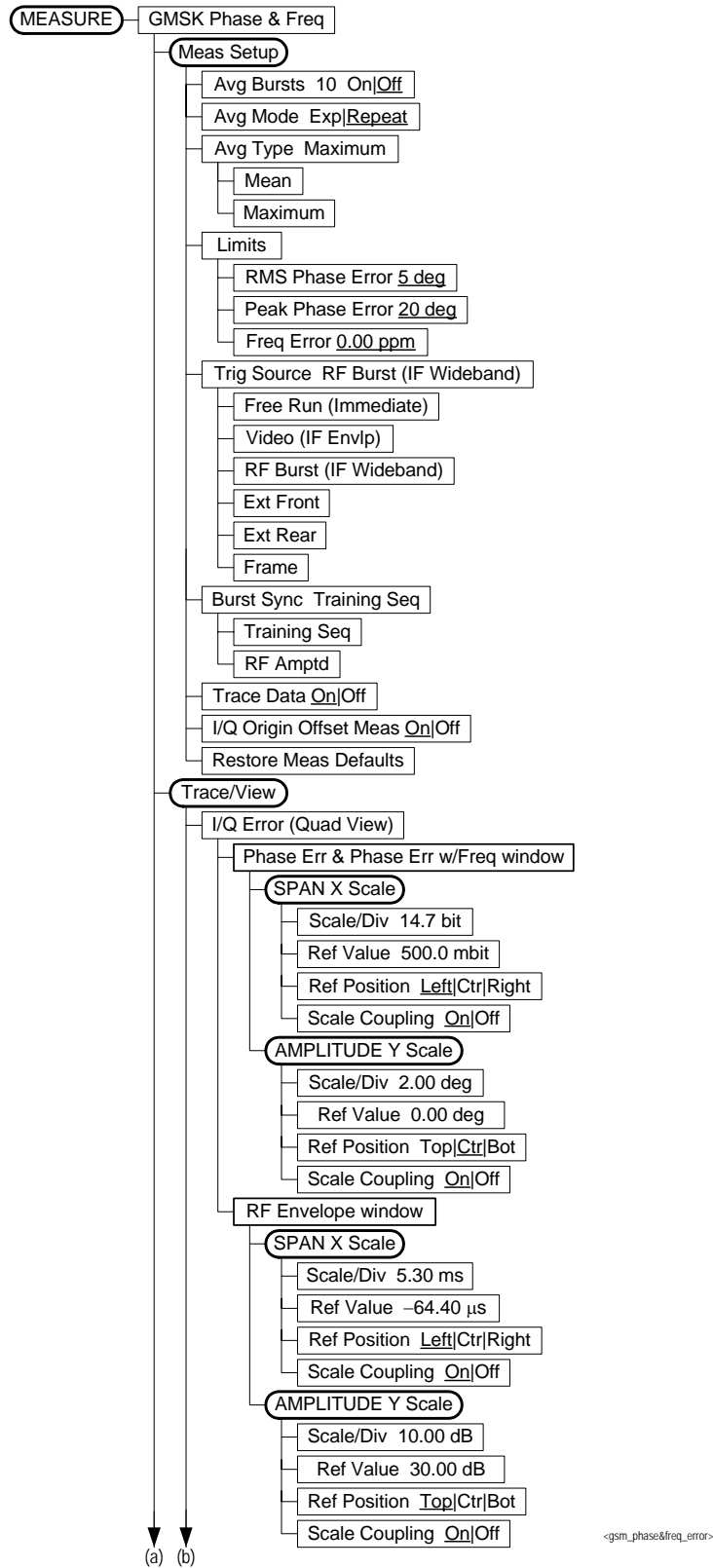
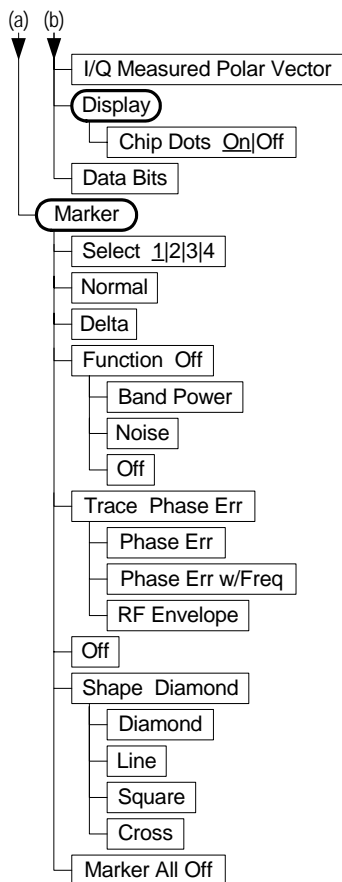


Figure 6-9 GSMK Phase & Frequency Error Measurement Key Flow (2 of 2)



<gsm\_phase&freq\_error2>

Figure 6-10 GMSK Output RF Spectrum Measurement Key Flow (1 of 2)

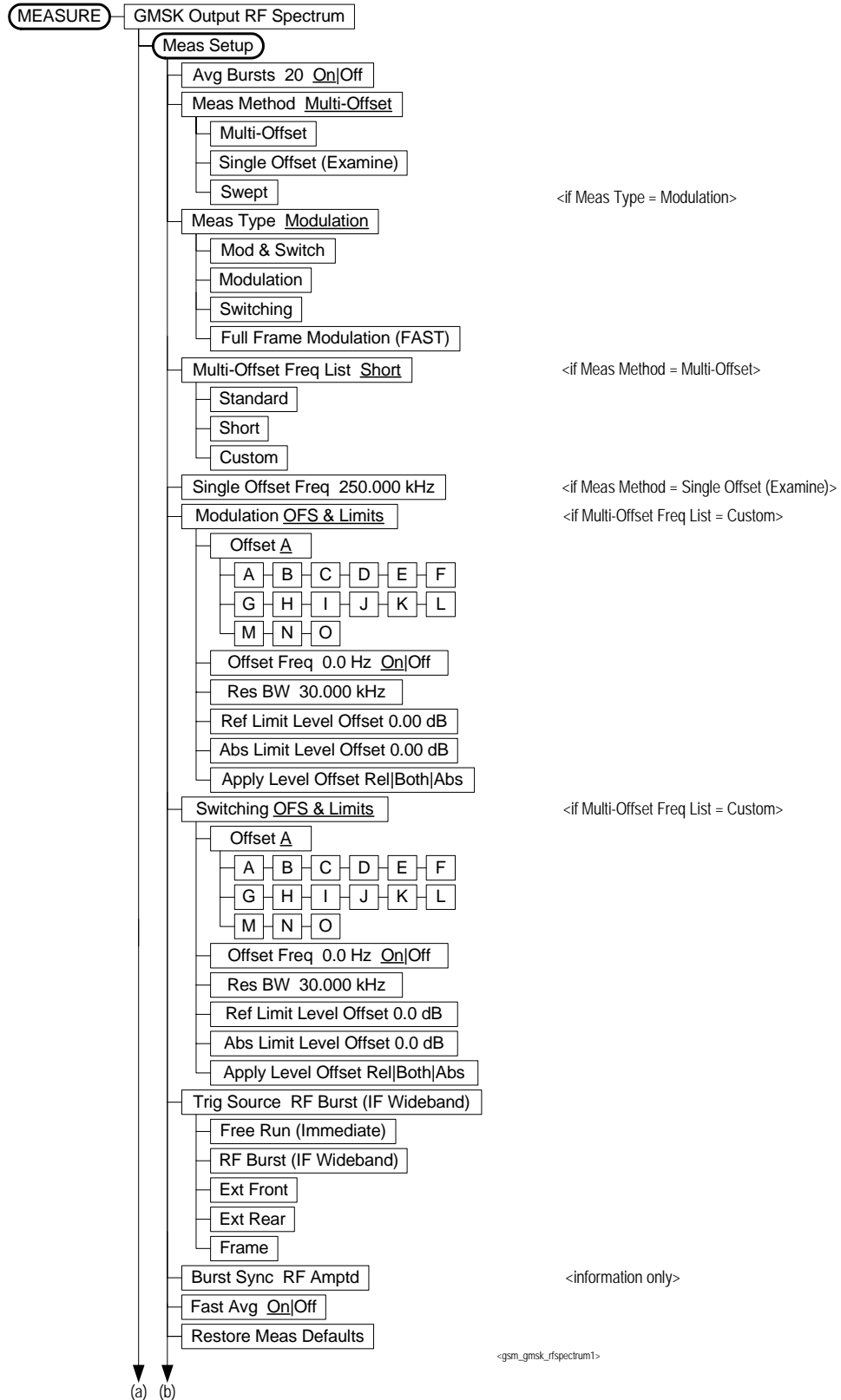
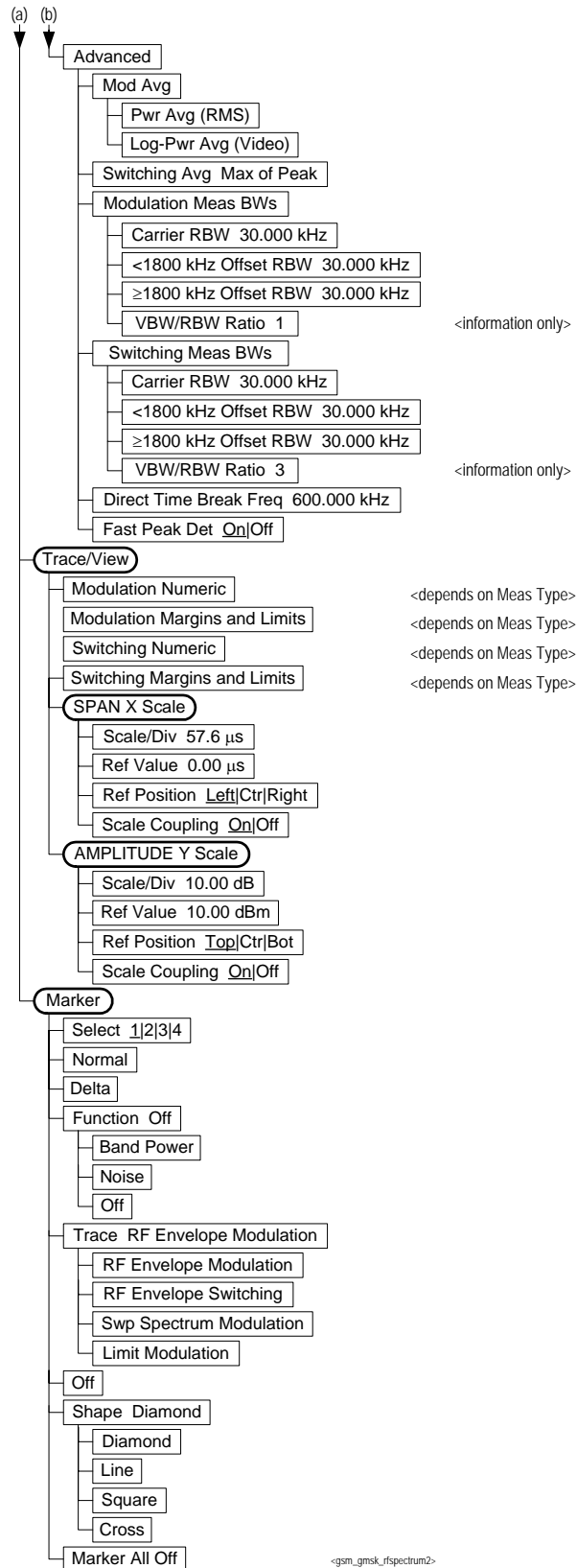


Figure 6-11 GMSK Output RF Spectrum Measurement Key Flow (2 of 2)



-gsm\_gmsk\_rfspectrum2-

Figure 6-12 GMSK Tx Band Spur Measurement Key Flow

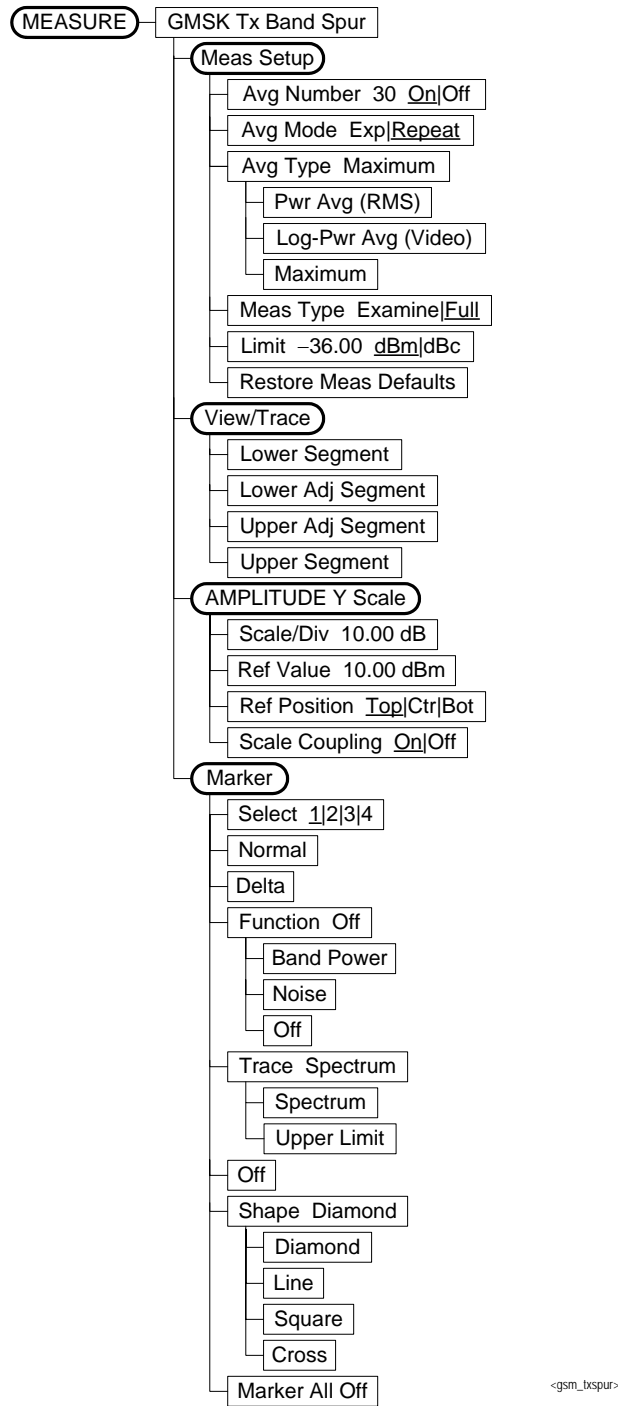




Figure 6-13 EDGE Power vs. Time Measurement Key Flow

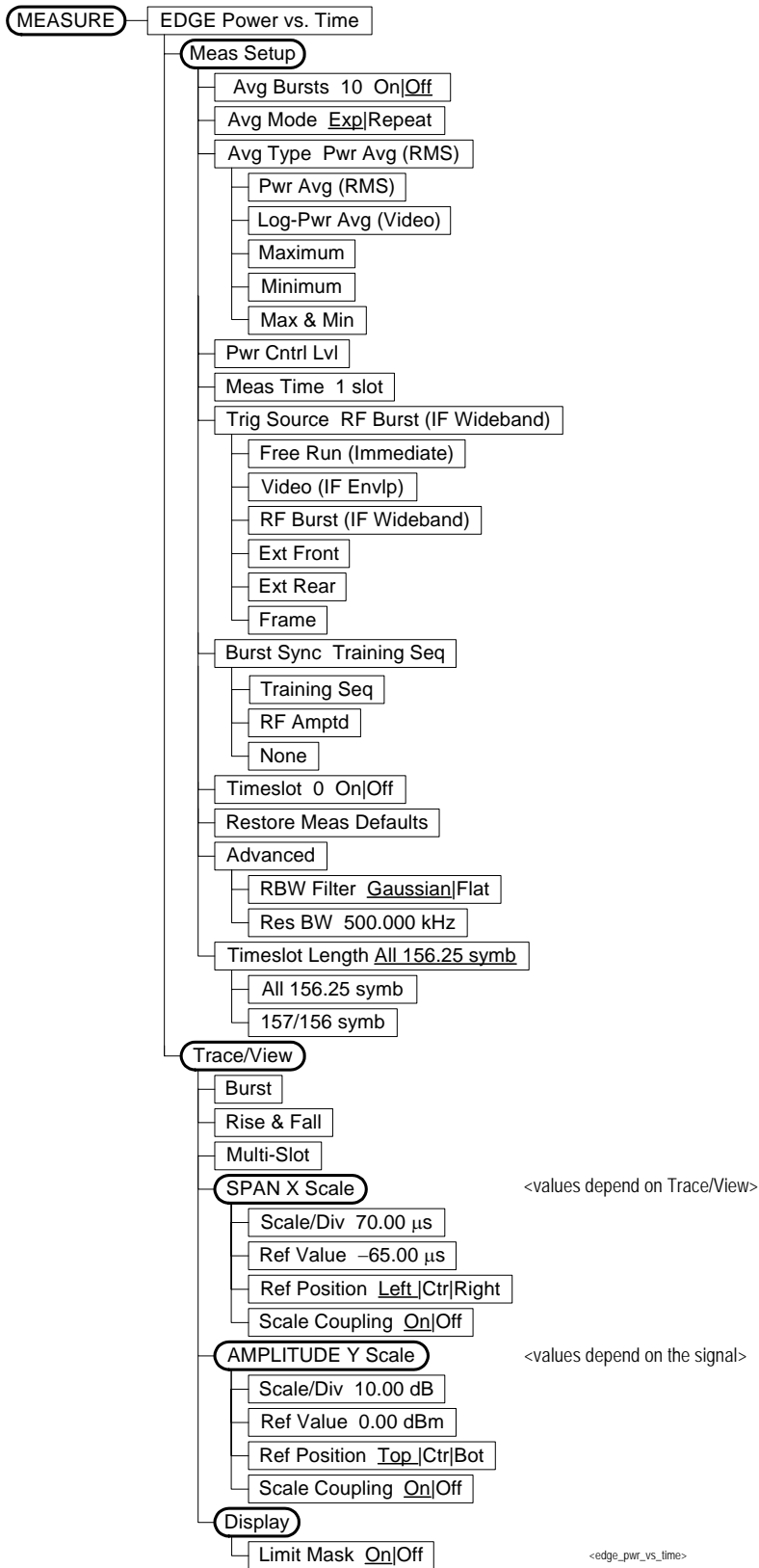
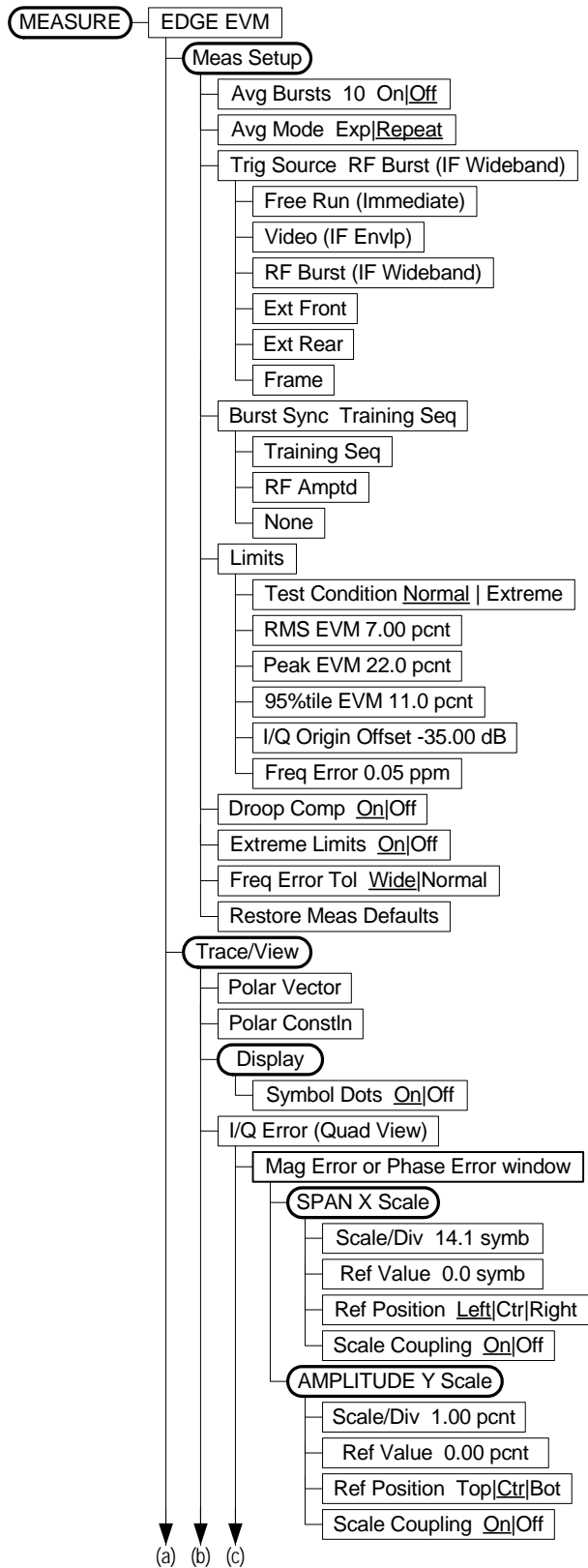


Figure 6-14 EDGE EVM Measurement Key Flow (1 of 2)



<edge\_evm1>

Figure 6-15 EDGE EVM Measurement Key Flow (2 of 2)

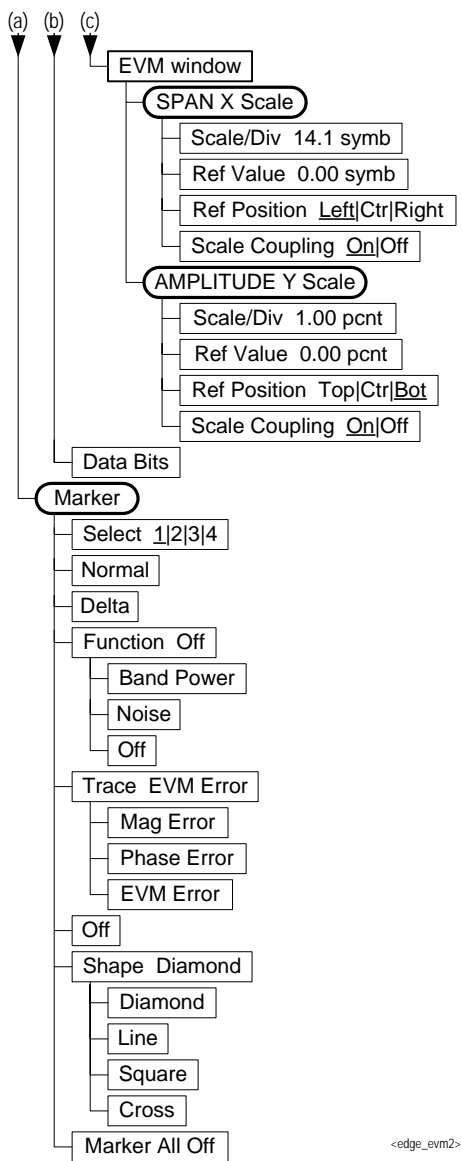


Figure 6-16 EDGE Output RF Spectrum Measurement Key Flow (1 of 2)

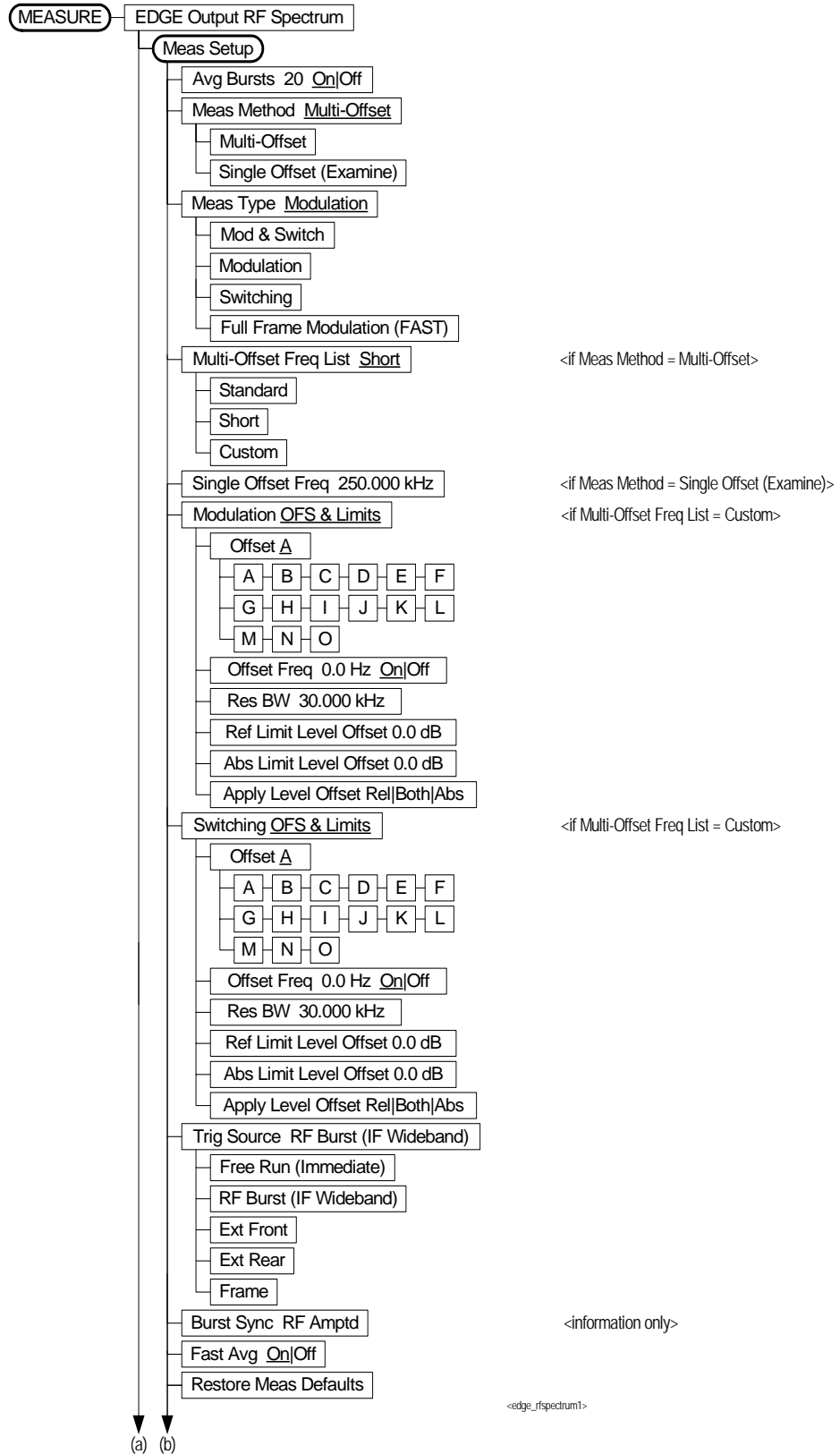


Figure 6-17 EDGE Output RF Spectrum Measurement Key Flow (2 of 2)

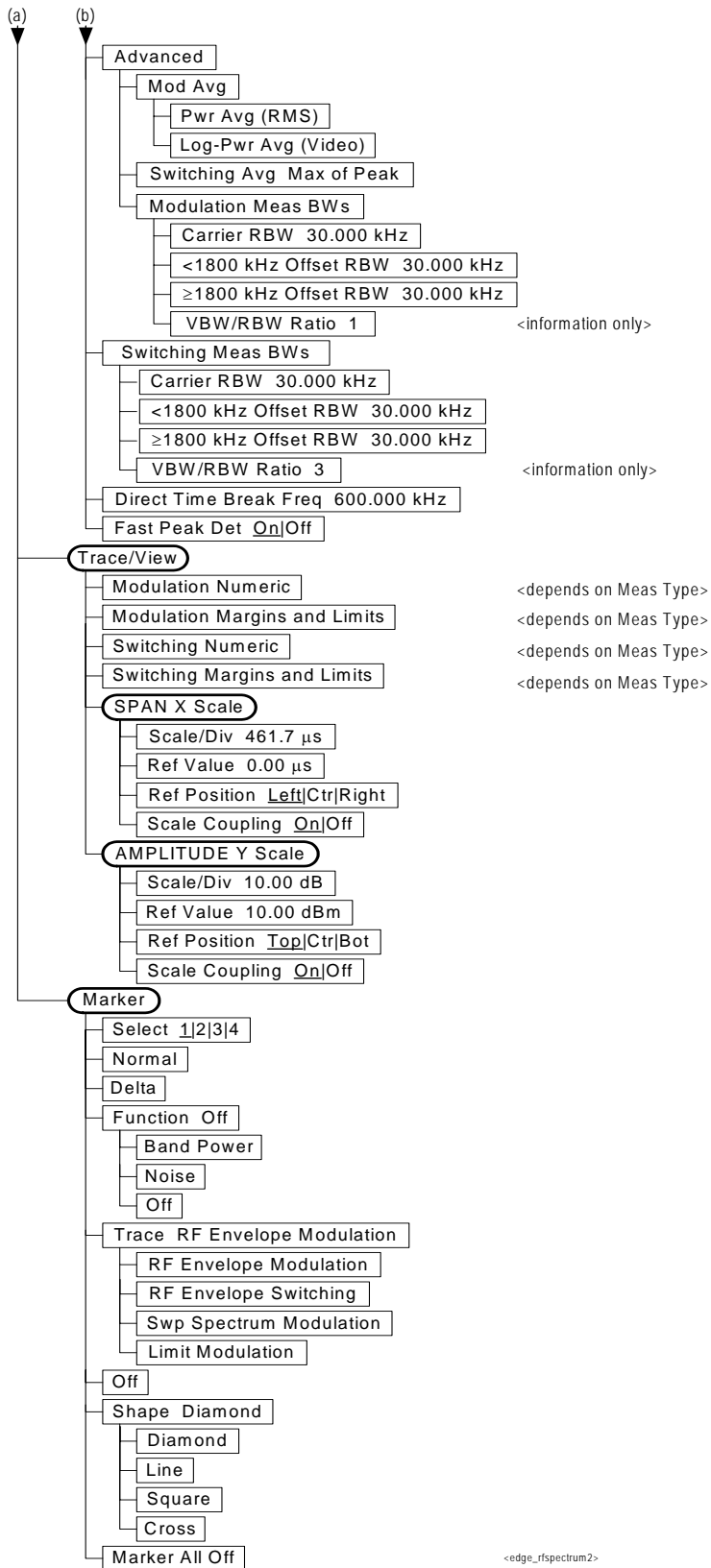


Figure 6-18 EDGE Tx Band Spur Measurement Key Flow

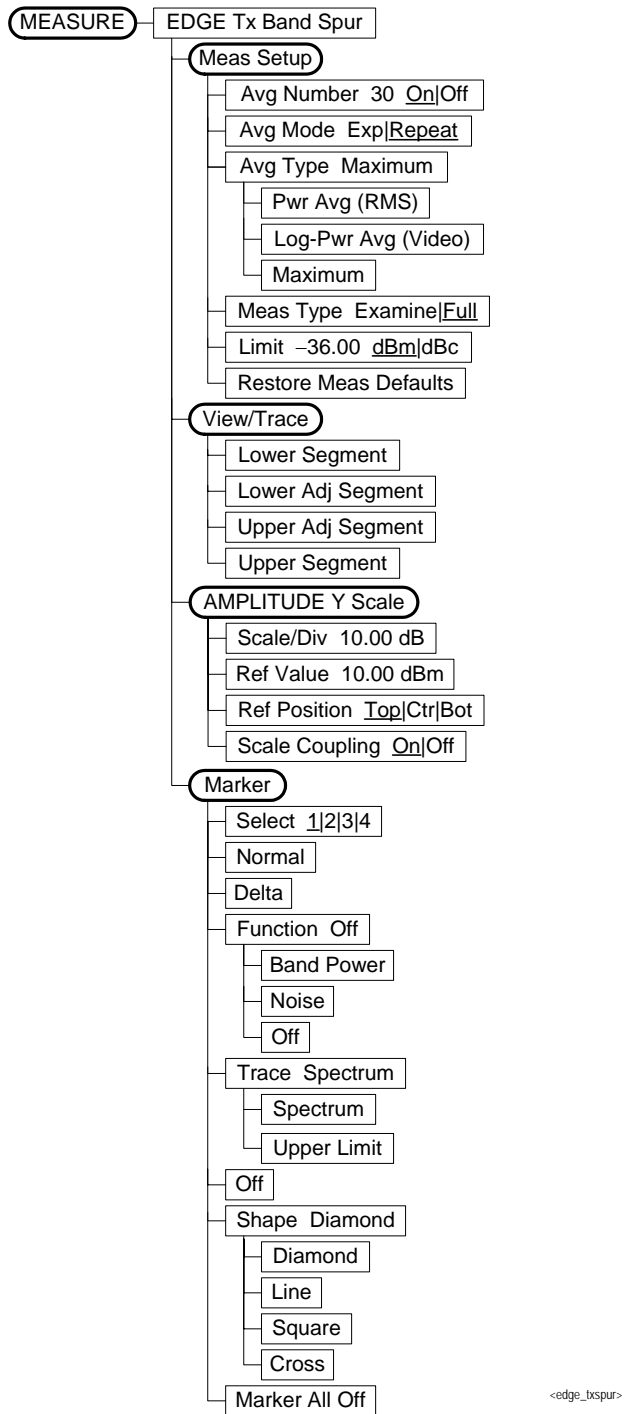


Figure 6-19 Spectrum (Freq Domain) Measurement Key Flow (1 of 3)

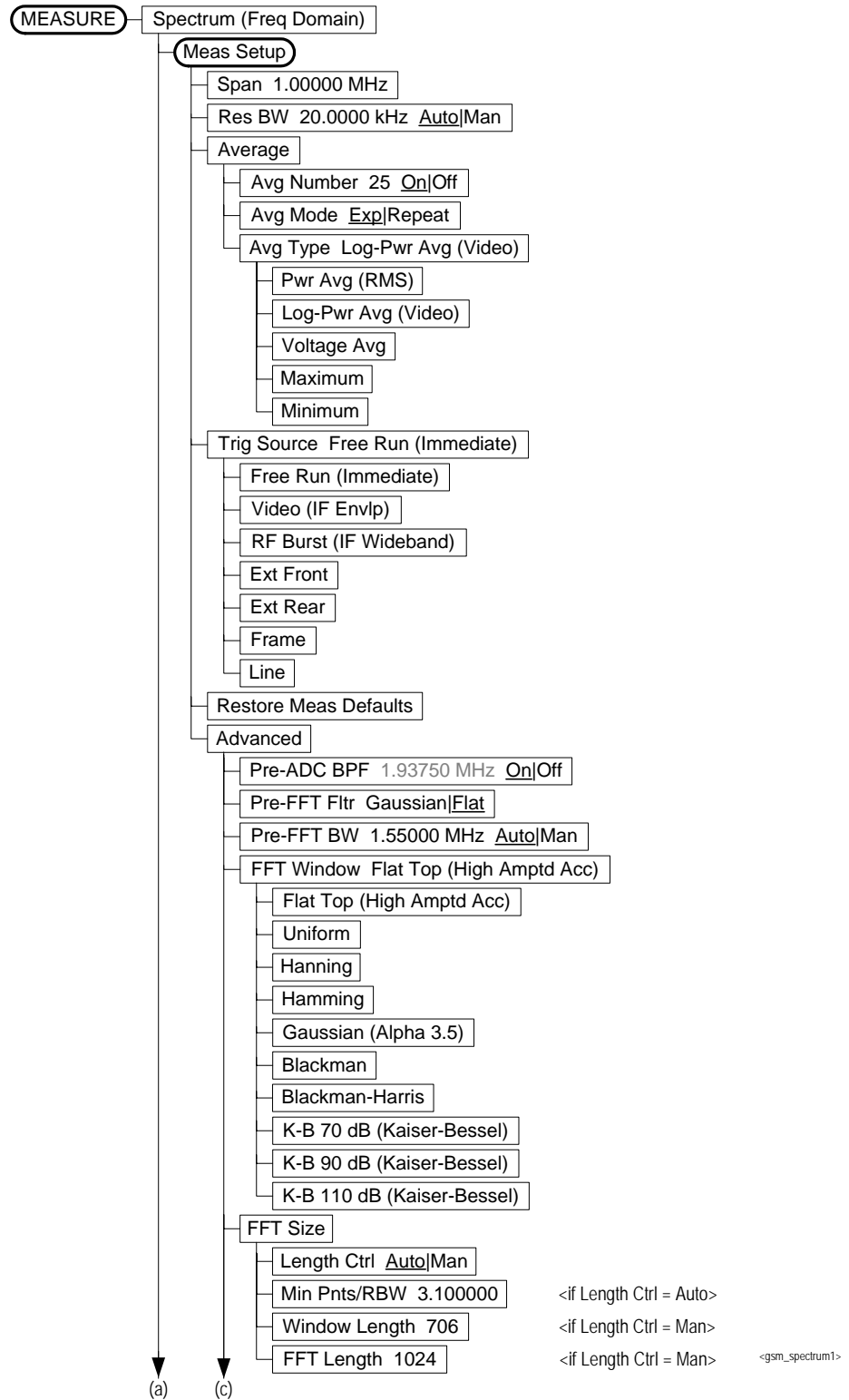


Figure 6-20 Spectrum (Freq Domain) Measurement Key Flow (2 of 3)

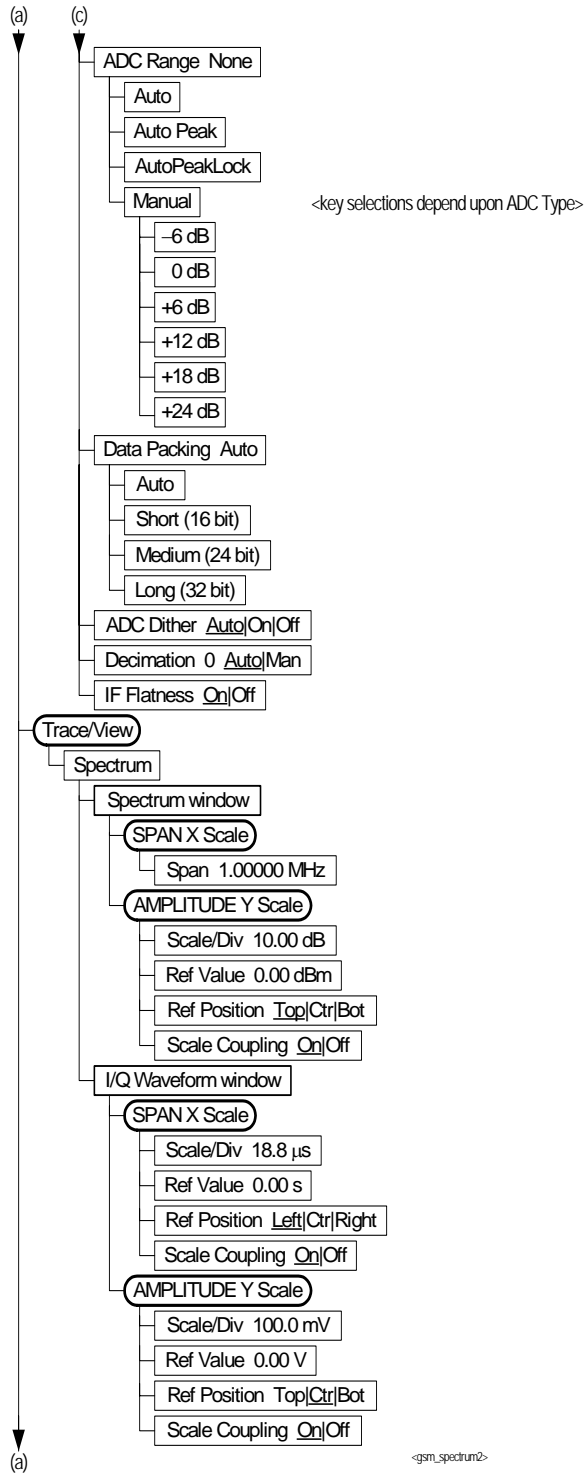




Figure 6-21 Spectrum (Freq Domain) Measurement Key Flow (3 of 3)

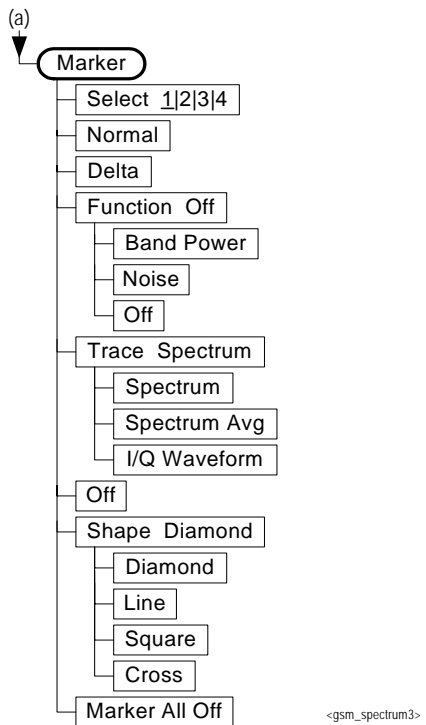


Figure 6-22 Waveform (Time Domain) Measurement Key Flow (1 of 2)

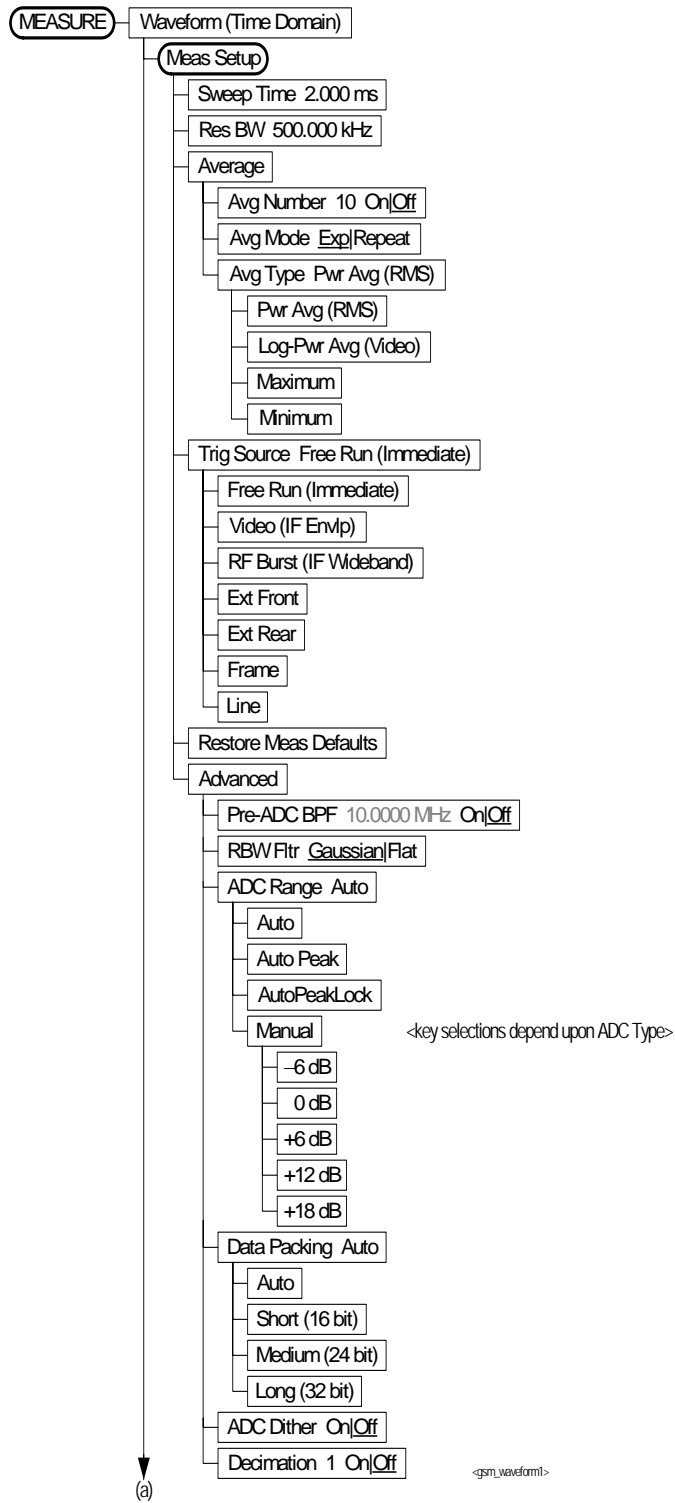
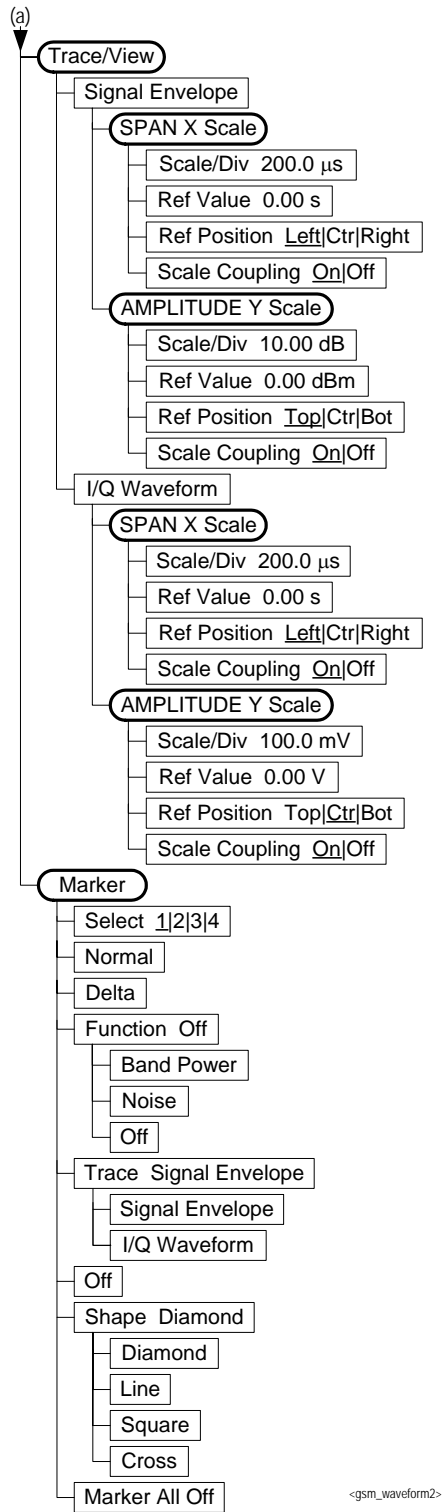


Figure 6-23 Waveform (Time Domain) Measurement Key Flow (2 of 2)





**Numerics**

- 1 Mohm balanced, [149](#)
- 1 Mohm unbalanced, [149](#)
- 50 MHz reference adjustment, [337](#)
- 50 ohm unbalanced, [149](#)
- 600 ohm balanced, [149](#)

**A**

- ACP
  - view of data, [312](#)
- acquisition packing
  - WAVEform, [494](#)
- active license key, [41](#)
  - how to locate, [41](#)
- ADC Dither key
  - spectrum measurement, [218](#)
- ADC dithering
  - SPECTrum, [471](#), [494](#)
- ADC filter
  - WAVEform, [495](#)
- ADC range
  - SPECTrum, [472](#)
  - WAVEform, [495](#)
- ADC Range key
  - spectrum measurement, [217](#)
- ADC ranging function
  - automatic control, [235](#)
  - automatic peak control, [235](#)
  - automatic peak lock, [235](#)
  - manual control, [235](#)
- adjust timebase frequency, [365](#)
- adjustment
  - 50 MHz reference, [337](#)
- Advanced menu
  - spectrum, [216](#)
  - waveform
    - waveform
      - advanced settings, [235](#)
- advanced menu
  - ADC dither, [236](#)
  - ADC ranging function, [235](#)
  - decimation, [236](#)
  - pre-ADC bandpass filter, [235](#)
  - resolution bandwidth filter, [235](#)
- align 50 MHz reference, [337](#)
- amplitude
  - input range, [445](#)
  - maximizing input signal, [445](#)
- ANSI standards, [513](#)
- applications
  - currently available, [329](#)
  - applications, selecting, [329](#), [330](#)
- ARFCN definition, [513](#)
- ARFCN setting, [374](#), [375](#), [376](#)

- ASCII data format, [325](#)
- attenuation
  - setting, [444](#)
- averaging
  - CSPur, [419](#), [488](#)
  - EVM, [380](#), [381](#)
  - ORFSpectrum, [385](#), [386](#), [424](#), [425](#)
  - output RF spectrum, [385](#), [386](#), [424](#), [425](#)
  - phase & frequency error, [440](#), [441](#)
  - phase and frequency error measurement, [440](#)
  - power vs. time, [403](#), [404](#), [447](#), [448](#)
  - SPECTrum, [473](#), [474](#), [475](#)
  - transmit band spurs, [372](#), [373](#), [418](#), [443](#), [487](#), [488](#), [496](#)
  - transmit power, [490](#), [491](#)
  - WAVEform, [496](#), [497](#)
- averaging state
  - power vs. time, [403](#), [447](#)

**B**

- bandwidth
  - ORFSpectrum, [386](#), [388](#), [392](#), [426](#), [427](#), [429](#)
  - output RF spectrum, [387](#), [388](#), [389](#), [390](#), [426](#), [427](#), [428](#), [429](#)
  - power vs. time, [405](#), [449](#)
  - PVTime, [405](#), [450](#)
  - SPECTrum, [478](#)
  - transmit power, [491](#)
  - TXPower, [491](#)
  - WAVEform, [498](#), [499](#)
- base station testing, [464](#)
- base transmit station
  - loss correction, [379](#)
- Baseband I/Q inputs
  - key access table, [251](#)
  - key entries, [251](#)
  - key path, [251](#)
- Baseband IQ measurements, [127](#)
- basic mode, [132](#)
- binary data order, [325](#)
- burst carriers, [464](#)
- burst search threshold, [486](#)
- burst synchronization, [381](#)
- burst trigger
  - level, [507](#)
- byte order of data, [325](#)
- C**
- carrier
  - type, [463](#), [464](#)
  - carrier selection, [463](#)

- center frequency setting, [422](#)
- center frequency step size, [422](#)
- changing
  - instrument settings, [372](#)
- channel burst type, [376](#)
- channel number
  - ARFCN, [374](#), [375](#), [376](#)
- Choose Option key, [40](#)
- code, programming
  - compatibility across PSA modes, [255](#), [257](#)
  - compatibility, PSA series versus VSA, [258](#)
- commands
  - compatibility across PSA modes, [255](#), [257](#)
  - CONFigure, [335](#)
  - FETCH, [335](#)
  - INITiate, [336](#)
  - MEASure, [334](#)
  - PSA series versus VSA
    - compatibility, [258](#)
    - READ, [336](#)
  - compatibility, programming
    - across PSA modes, [255](#)
    - PSA series versus VSA, [258](#)
  - CONFigure command use, [332](#)
  - CONFigure commands, [335](#)
  - Continuous carrier GMSK Phase and Freq measurements, [522](#)
  - continuous carriers, [464](#)
  - continuous vs. single
    - measurement mode, [327](#)
  - control measurement commands, [327](#)
  - correction
    - base transmit station loss, [379](#)
    - mobile station loss, [379](#)
  - Current Data, EDGE PvT, [52](#), [94](#), [207](#), [520](#)
  - current measurement, [311](#)
  - curve fit the data, [263](#), [272](#)
- D**
- data
  - querying, [262](#), [263](#), [272](#)
  - data decimation, [479](#)
    - WAVEform, [499](#), [500](#)
  - data format, [325](#)
  - data from measurements, [332](#)
  - Data Packing
    - spectrum measurement, [217](#), [235](#)
  - DCS1800, [465](#)
  - Decimation
    - spectrum measurement, [218](#)
  - decimation

# Index

- SPECTrum, 479
  - decimation of data
    - WAVEform, 499, 500
  - default states, 48, 142
  - default values, setting remotely, 335
  - deleting an
    - application/personality, 35
  - delta markers, 295
  - display
    - on/off, 312
    - PVT limits, 313, 314
    - spectrum window, 315, 316, 321, 322
    - tiling, 313
    - trace, 317
    - window tile, 313
    - zoom, 313
  - display ACP data, 312
  - display commands, 312
  - dithering the ADC, 471, 494
  - downlink
    - definition of, 513
  - Droop amplitude, EDGE EVM, 154, 532
  - Droop Compensation key, 154
  - Droop Error, EDGE EVM, 339
  - Dynamic Range Not Optimum message, 149
- E**
- EDGE error vector magnitude, Meas Setup Key Menu, 152
  - EDGE EVM, Droop amplitude, 154, 532
  - EDGE EVM, TSC (Training Sequence) Burst Sync, 155
  - EDGE EVM, Droop Error, 339
  - EDGE ORFS
    - burst sync setup, 165
    - fast averaging setup, 165
    - meas method
      - multi-offset, 62, 162
      - single offset, 62
      - single offset (examine), 163
      - swept, 63, 163
    - meas type
      - Full Frame (FAST), 62, 162
      - mod & switch, 62, 162
      - modulation, 62, 162
      - switching, 62, 162
    - modulation offsets & limits
      - Abs limit level offset setup, 164, 185
      - apply level offset setup, 164, 185
      - offset freq setup, 163, 185
      - offset setup, 163, 185
      - Rel limit level offset setup, 164, 185
      - Res BW setup, 163, 185
    - modulation offsets & limits setup, 163, 185
    - multi-offset freq list, 163, 185
    - offsets & limits
      - offset freq setup, 164
      - switching offsets & limits
        - Abs limit level offset setup, 164, 186
        - apply level offset setup, 164, 186
        - offset freq setup, 164, 186
        - offset setup, 164, 186
        - Rel limit level offset setup, 164, 186
        - Res BW setup, 164, 186
        - trigger source setup, 165
  - EDGE PvT, Current Data, 52, 94, 207, 520
  - EDGE transmit band spurs measurement, 418
  - EGSM
    - RGSM
      - DCS, 465
  - error vector magnitude
    - measuring, 56, 532
  - error vector magnitude measurement, 338, 380
  - error vector measurement
    - See also EVM
  - ETSI standards, 34
  - EVM
    - averaging, 380, 381
    - burst synchronization, 381
    - symbol dots, 382, 383
    - trigger source, 383
  - EVM Limits menu, 154
  - external reference, 468
  - external trigger
    - delay, 503
    - level, 503
    - slope, 504
  - Extreme Limits menu, 154
- F**
- fast averaging
    - EDGE ORFS, 165
    - GMSK ORFS, 188
  - Fast Peak Det, EDGE mode, 167, 189
  - FETCh command use, 332
  - FETCh commands, 335
  - FFT
    - SPECTrum, 479, 480, 481, 482
    - FFT bandwidth, SPECTrum, 476, 477
    - FFT Length key, 217
    - FFT Size menu, 217
    - FFT Window key, 216
    - format, data, 325
    - frame trigger adjustment, 504, 505
    - frame trigger period, 504
    - frame trigger sync mode, 505
    - frequency
      - carrier setting, 463
      - center, 422
      - step size, 422
    - frequency offsets
      - ORFSpectrum, 395
      - output RF spectrum, 432
    - frequency span
      - SPECTrum, 482
    - Full Frame Modulation (FAST), 62, 77, 162
    - GMSK ORFS, 184
    - Full Screen key, 314
- G**
- GMSK ORFS
    - average bursts setup, 184
    - burst sync setup, 186
    - fast averaging setup, 188
    - meas method
      - multi-offset, 77
      - multi-offset (list mode), 184
      - setup, 184
      - single offset (examine), 77, 184
      - swept, 78, 184
    - meas type
      - full frame (FAST), 77
      - full frame modulation (FAST), 184
      - mod & switch, 77, 184
      - modulation, 77, 184
      - switching, 77, 184
    - measurement results
      - Multi-Offset Modulation Margin & Limits view, 170, 192
      - Multi-Offset Modulation Power view, 169, 191
      - Multi-Offset Switching Margin & Limits view, 172, 194
      - Multi-Offset Switching Power view, 171, 193
    - measurement type setup, 184
    - offset freq setup, 186
    - trigger source setup, 186

- GMSK Phase and Freq
  - measurements, Continuous carrier, 522
- GPRS signals, making PvT measurements, 517
- GSM measurement, 394, 399, 403, 430, 434, 447, 490
- GSM standards
  - DCS 1800, 143, 511
  - E-GSM, 143, 511
  - GSM 1900, 143, 511
  - GSM 450, 143, 511
  - GSM 480, 143, 511
  - GSM 700, 143, 511
  - GSM 850, 143, 511
  - GSM 900, 143, 511
  - PCS 1900, 143, 511
  - P-GSM, 143, 511
  - R-GSM, 143, 511
- GSM450, 465
- GSM480, 465
- GSM850, 465
- H**
  - hopping carriers, 463
- I**
  - I and Q waveform view
    - I or Q waveform window, 226
    - I waveform window, 244
    - Q waveform window, 244
  - I offset, 148
  - I or Q waveform window
    - amplitude Y scale, 226
    - reference position, 226
    - reference value, 226
    - scale coupling, 226
    - scale per division, 226
    - span X scale
      - reference position, 225, 242
      - reference value, 225, 242
      - scale coupling, 225, 242
      - scale per division, 225, 241
  - I origin
    - I/Q polar window, 242, 245
  - I Origin key, 225, 227
  - I waveform window
    - amplitude Y scale, 244
    - reference position, 245
    - scale coupling, 245
    - scale per division, 244
  - I/Q data output, 132
  - I/Q data results, 362, 369
  - I/Q impedance reference, 149
  - I/Q input impedance, 148
  - I/Q marker query, 308, 310
  - I/Q origin offset
    - phase & frequency error, 441
  - I/Q origin offset meas, phase and freq measurement, 197
  - I/Q Polar view
    - waveform measurement, 242, 245
  - I/Q polar view
    - I/Q polar window, 225, 227, 242, 245
  - I/Q polar window
    - amplitude Y scale, 227
    - I/Q scale per division, 225, 227
    - Q Origin, 225, 227
    - I origin, 242, 245
    - I/Q scale per division, 242, 245
    - Q origin, 242, 245
    - span X scale, 225, 227
    - I Origin, 225, 227
  - I/Q scale per division
    - I/Q polar window, 242, 245
  - I/Q Scale/Div key, 225, 227
  - I/Q setup, 148
  - I/Q waveform view
    - I/Q waveform window, 244
  - I/Q waveform window, 241, 242
    - amplitude Y scale, 244
    - reference position, 245
    - reference value, 244
    - scale coupling, 245
    - scale per division, 244
  - IF Flatness
    - advanced spectrum feature, 218
  - IF trigger delay, 506
  - IF trigger level, 506
  - IF trigger slope, 507
  - improving measurement speed, 62, 77, 162, 184
  - initial signal connection, 48
  - INITiate commands, 336
  - initiate measurement, 327, 328
  - input
    - external attenuator, 150
      - attenuation for BTS tests, 150
      - attenuation for MS tests, 150
    - input attenuator, 150, 151
    - input port, 148
      - 50 MHz reference, 148
      - Baseband Align Signal, 148
      - rf, 148
      - max total power, 150
      - maximum total power, 149
      - RF input range, 149
    - input attenuation, 444
    - Input Key, 148
    - input port
      - 50 MHz reference, 148
      - I only, 148
    - I/Q, 148
    - IF align, 148
    - Q only, 148
  - input port selection, 420
  - input power
    - maximum, 445
    - range, 445
  - Install Now key, 40
  - Installing and Obtaining a license key, 39
  - installing measurement personalities, 35
  - instrument configuration, 329
  - internal reference, 468
  - internal reference selection, 420
  - Internal RF Preamplifier, 150
  - IQ input selection, 420
  - IQ port selection, 420
  - K**
    - key flow diagram
      - EDGE EVM Measurement, 556
      - EDGE ORFS Measurement, 556
      - EDGE PVT Measurement, 556
      - EDGE Tx Band Spur Measurement, 556
      - GMSK ORFS Measurement, 556
      - GMSK Phase and Freq. Measurement, 556
      - GMSK PVT Measurement, 556
      - Measurement selection, 556
      - Mode selection, 556
      - mode setup / frequency channel, 556
      - spectrum (frequency domain), 556
      - Transmit Power Measurement, 556
      - Tx Band Spur, 556
      - waveform (time domain), 556
  - L**
    - Length Ctrl key, 217
    - Length key, 217
    - license key
      - obtaining and installing, 39
    - limit line testing, 261
    - limit testing
      - TSPur, 290, 309
    - linear envelope view
      - linear envelope window, 243
      - phase window, 244
    - linear envelope window, 241, 242
      - amplitude Y scale, 243
      - reference position, 243
      - reference value, 243

# Index

- scale coupling, 244
  - scale per division, 243
  - linear spectrum window
    - amplitude Y scale
      - reference position, 226
      - reference value, 226
      - scale coupling, 226
      - scale per division, 226
    - span, 225
  - loading an
    - application/personality, 35
- M**
- major functional keys, 136
  - making measurements, 332
  - marker
    - I/Q query, 308, 310
  - markers, 291
    - assigning them to traces, 296
    - maximum, 294
    - minimum, 295
    - off, 296
    - trace assignment, 300, 301
    - turn off, 294
    - type, 295
    - valid measurement, 291
    - value, 301
    - value of, 294
    - x-axis location, 300, 301
    - y-axis, 301
  - masks
    - power vs. time, 407, 408, 409, 410, 412, 452, 453, 454, 455, 456, 457, 458
  - maximum value of trace data, 263, 272
  - Mean Transmit Power, P<sub>V</sub>T
    - measurement, 52, 94, 206, 520
  - Mean Transmit Pwr, P<sub>V</sub>T
    - measurement, 52, 94, 207, 520
  - mean value of trace data, 263, 272
  - MEASure command use, 332
  - MEASure commands, 334
  - measure setup
    - restore measurement defaults, 216, 235
  - measurement
    - error vector magnitude, 380
    - markers, 291
    - output RF spectrum, 385, 423
    - phase and frequency error, 439
    - power vs. time, 403, 447
    - query current, 311
    - spectrum (frequency domain), 471
    - transmit band spurs, 418, 487
    - transmit power, 490
    - waveform (time domain), 494
  - measurement key flow, 556
  - measurement method
    - output RF spectrum, 400, 437
  - measurement modes
    - currently available, 329
    - selecting, 329, 330
  - measurement setup
    - averaging mode, 214, 233
      - exponential, 214, 233
    - averaging number, 214, 233
    - averaging type, 215, 234
      - log power average (video), 215, 234
    - maximum voltage average, 215, 234
    - minimum voltage average, 215, 234
    - power average (rms), 215, 234
    - voltage average, 215, 234
  - measurement type
    - transmit band spurs, 419, 489
  - measurements
    - CONF/FETC/MEAS/READ
      - commands, 332
    - control of, 327
    - error vector magnitude, 338
    - getting results, 332
    - output RF spectrum, 341, 350
    - phase and frequency error, 354
    - power vs. time, 345, 357
    - setting default values remotely, 335
    - single/continuous, 327
    - spectrum (frequency domain), 362
    - transmit band spurs, 348, 366
    - transmit power, 367
    - waveform (time domain), 369
  - measuring I/Q data, 362, 369
  - memory
    - security erase, 42
  - Min Pts in RBW key, 217
  - minimum value of trace data, 263, 272
  - missing options, 35
  - mobile station
    - loss correction, 379
  - mobile station testing, 464
- N**
- normal marker, 295
- O**
- offset frequency
    - output RF spectrum, 400, 438
  - options
    - loading/deleting, 35
  - options not in instrument
    - memory, 35
  - ORFS, 62, 77, 162, 167, 184, 189
  - ORFSpectrum
    - bandwidth, 392, 429, 434
    - bandwidth, 398
    - l offset
      - output RF spectrum
        - measurement, 394, 399, 430, 434
      - measurement type, 402, 439
      - offsets, 395, 399, 437
    - output RF spectrum
      - resolution bandwidth for
        - switching transients at close offsets, 389, 427
      - trigger source, 401, 438
    - output RF spectrum - averaging control, 386, 425
    - output RF spectrum - number of bursts averaged, 385, 424
    - output RF spectrum - offset frequency, 400, 438
    - output RF spectrum - offset frequency list, 432
    - output RF spectrum - resolution bandwidth for switching transients at far offsets, 389, 390, 428, 429
    - output RF spectrum - resolution BW for modulation at close offsets, 387, 426
    - output RF spectrum - resolution BW for modulation at far offsets, 388, 427
    - output RF spectrum
      - measurement, 341, 350, 385, 423
      - See also ORFSpectrum
      - See also orfspectrum
    - output RF spectrum
      - measurement method, 400, 437
- P**
- packing
    - SPECTrum, 471
  - pass/fail test, 261
  - PCS, 465
  - PCS1900, 465
  - personalities
    - currently available, 329
    - selecting, 329, 330



- personality options not in instrument, 35  
 PGSM, 465  
 Phase & frequency error  
   I/Q origin offset, 441  
 phase & frequency error - averaging mode, 440  
 phase & frequency error - averaging state, 440  
 phase & frequency error - averaging type, 441  
 phase & frequency error - burst synchronization, 441  
 phase & frequency error - number of bursts averaged, 440  
 phase & frequency error - trace data, 442  
 phase & frequency error - trigger source, 442  
 phase and freq measurement, I/Q origin offset meas, 197  
 phase and freq measurement, Trace Data, 197  
 phase and frequency error measurement, 354, 439  
   See also PFERror  
 phase window, 241, 242  
   amplitude Y scale, 244  
   reference position, 244  
   reference value, 244  
   scale per division, 244  
 power threshold  
   setting, 486  
 power vs. time  
   averaging state, 403, 447  
   power vs. time - averaging mode, 403, 448  
   power vs. time - averaging type, 404, 448  
   power vs. time - custom limit masks, 412, 458  
   power vs. time - limit line mask display, 407, 452  
   power vs. time - lower mask absolute amplitude levels, 407, 452  
   power vs. time - lower mask points, 408, 453  
   power vs. time - lower mask relative amplitude levels, 408, 453  
   power vs. time - lower mask time points, 409, 454  
   power vs. time - number of bursts averaged, 403, 447  
   power vs. time - resolution bandwidth, 405, 449  
   power vs. time - trigger source, 416, 461  
   power vs. time - upper mask absolute amplitude levels, 409, 455  
   power vs. time - upper mask points, 410, 455  
   power vs. time - upper mask relative amplitude levels, 410, 456  
   power vs. time - upper mask time points, 412, 457  
   power vs. time measurement, 345, 357, 403, 447  
   See also PVTime  
   pre-ADC bandpass filter SPECTrum, 476  
   Pre-ADC BPF key spectrum measurement, 216  
   Preamplifier  
     Setting the internal preamplifier, 150  
   pre-FFT bandwidth, SPECTrum, 476, 477  
   Pre-FFT BW key, 216  
   Pre-FFT Fltr key, 216  
   preset, 48  
   factory defaults, 48  
   preset states, 48, 142  
   programming  
     compatibility among PSA modes, 255, 257  
     compatibility, PSA series versus VSA, 258  
   PSA series versus VSA (programming compatibility), 258  
   PVT limits display, 313, 314  
   PvT measurement, Mean Transmit Power, 52, 94, 206, 520  
   PvT measurement, Mean Transmit Pwr, 52, 94, 207, 520  
   PvT measurements of GPRS signals, 517  
   PVTime  
     bandwidth, 405, 450  
     sweep time, 415, 461, 492
- Q**  
 Q offset, 148  
 Q origin  
   I/Q Polar window, 242, 245  
   I/Q polar window, 242, 245  
 Q Origin key, 225, 227  
 Q waveform window  
   amplitude Y scale, 244  
   reference position, 245  
   reference value, 244  
   scale coupling, 245  
   scale per division, 244  
 query data, 262, 263, 272
- R**  
 READ command use, 332  
 READ commands, 336  
 real number data format, 325  
 rear panel external trigger delay, 503  
   slope, 504  
 reference  
   external, 468  
   internal, 468  
 reference, selecting internal, 420  
 Res BW key  
   spectrum measurement, 214  
   waveform measurement, 233  
 restart measurement, 328  
 results, waveform measurement, 545  
 return data, 262, 263, 272  
 RF input selection, 420  
 RF input, selection, 420  
 RMS of trace data, 263, 272
- S**  
 sampling trace data, 263, 272  
 security memory erase procedure, information and Agilent website, 42  
 select the ARFCN - absolute RF channel number, 374  
 selecting channel, 376  
 sensors, temperature, 361  
 signal envelope view  
   signal envelope window, 243  
 signal envelope window, 241, 242  
   amplitude Y scale, 243  
   reference position, 243  
   reference value, 243  
   scale coupling, 243  
   scale per division, 243  
 single vs. continuous measurement mode, 327  
 slots, setting, 415, 461, 492  
 span  
   SPECTrum, 482  
 Span key  
   spectrum measurement, 214  
 SPECTrum  
   acquisition packing, 471  
   ADC range, 472  
   data decimation, 479

# Index

- FFT length, [479](#), [480](#)
- FFT resolution BW, [480](#)
- FFT window, [481](#), [482](#)
- FFT window delay, [481](#)
- frequency span, [482](#)
- sweep time, [483](#)
- trigger source, [484](#)
- spectrum
  - all traces, [224](#), [241](#)
  - averaged trace, [224](#), [241](#)
  - changing views, [104](#), [220](#)
  - current trace, [224](#), [241](#)
  - I signal trace, [224](#), [241](#)
  - next window selection, [220](#)
  - Q signal trace, [224](#), [241](#)
  - span X scale, [225](#)
  - trace display, [224](#), [241](#)
  - view/trace, [104](#), [220](#)
  - zoom a window, [220](#)
- Spectrum (Frequency Domain)
  - key, [214](#), [544](#)
- spectrum (frequency domain)
  - measurement, [362](#), [471](#)
  - See also SPECTrum
- spectrum measurement
  - basic mode, [132](#)
  - method, [544](#)
  - results, [103](#)
- spectrum measurement display, [315](#), [316](#), [321](#), [322](#)
- standard deviation of trace data, [263](#), [272](#)
- standard, selecting for GSM, [465](#)
- start measurement, [327](#), [328](#)
- state
  - changing, [372](#)
- status
  - temperature measurement, [361](#)
- sweep time
  - PVTime, [415](#), [461](#), [492](#)
  - SPECTrum, [483](#)
  - WAVEform, [500](#)
- Sweep Time key, [233](#)
- switching transients
  - ORFSpectrum, [398](#), [399](#), [434](#)
- symbol dots
  - EVM, [382](#), [383](#)
- sync alignment, [486](#)
- sync burst RF amplitude delay, [486](#)
- synchronization, [486](#)
  - EVM, [381](#)
  - GSM, [486](#)
  - phase & frequency error, [441](#)
- T**
- T0 point, [230](#)
- T0 trig
  - burst sync, [174](#)
- temperature sensor
  - measurement, [361](#)
- test limits, [261](#)
- tile the display, [313](#)
- time domain measurement, [369](#), [494](#)
- time domain measurements, [233](#), [545](#)
- time slot auto, [377](#)
- time slot number, [377](#)
- timebase frequency accuracy
  - measurement, [365](#)
- timeslot
  - definition of, [513](#)
- trace data
  - phase and frequency error
    - measurement, [442](#)
  - processing, [263](#), [272](#)
- Trace Data, phase and freq
  - measurement, [197](#)
- trace display, [317](#)
- trace format, [325](#)
- trace names for markers, [296](#)
- trace/view selection
  - magnitude & phase graph view, [121](#), [239](#)
- training sequence code (TSC), [378](#)
- training sequence code (TSC)
  - auto, [378](#)
- training sequence code channel, [376](#)
- training sequence code selection, [378](#)
- transmit band spurs
  - limit testing, [290](#), [309](#)
- transmit band spurs - average
  - count, [418](#), [487](#)
- transmit band spurs - averaging
  - state, [372](#), [373](#), [418](#), [443](#), [488](#), [496](#)
- transmit band spurs - averaging
  - termination control, [418](#), [488](#)
- transmit band spurs - type, [419](#), [489](#)
- transmit band spurs
  - measurement, [348](#), [366](#), [487](#)
- transmit power
  - resolution bandwidth, [491](#)
- transmit power - averaging mode, [490](#)
- transmit power - averaging state, [490](#)
- transmit power - averaging type, [491](#)
- transmit power - number of bursts
  - averaged, [490](#)
- transmit power measurement, [367](#), [490](#)
  - See also TXPower
- Trigger
  - T0 burst sync, [174](#)
- trigger
  - auto time, [502](#)
  - burst level, [507](#)
  - commands, [502](#)
  - delay, [503](#)
  - delay, IF, [506](#)
  - external, [503](#), [504](#)
  - frame adjustment, [504](#), [505](#)
  - frame period, [504](#)
  - frame sync mode, [505](#)
  - holdoff, [506](#)
  - level, [503](#)
  - level, IF, [506](#)
  - on/off, [502](#)
  - output RF spectrum, [401](#), [438](#)
  - phase & frequency error, [442](#)
  - power vs. time, [416](#), [461](#)
  - slope, [504](#)
  - slope, IF, [507](#)
  - SPECTrum, [484](#)
  - timeout, [502](#)
  - trigger source, [215](#), [234](#)
    - external front input, [215](#), [234](#)
    - external rear input, [215](#), [234](#)
    - frame clock, [215](#), [234](#)
    - free run (immediate), [215](#), [234](#)
    - line, [215](#), [234](#)
    - RF burst (wideband), [215](#), [234](#)
    - video (IF envelope), [215](#), [234](#)
  - TXPower, [493](#)
  - WAVEform, [501](#)
- trigger measurement, [327](#), [328](#)
- trigger source
  - EVM, [383](#)
- TSC (Training Sequence) Burst
  - Sync, EDGE EVM, [155](#)
- TSPur
  - limit testing, [290](#), [309](#)
- TXPower
  - trigger source, [493](#)
- U**
- Uninstall Now, [41](#), [42](#)
- uninstalling measurement
  - personalities, [35](#)
- uplink
  - definition of, [513](#)
- V**
- view ACP data, [312](#)

- 
- view commands, [312](#)
  - view/trace
    - I/Q waveforms, [107](#), [223](#)
    - linear spectrum and phase graphs, [106](#), [222](#)
    - spectrum graph, [104](#), [220](#)
  - view/trace selection
    - I and Q Waveform view, [122](#), [240](#)
    - I and Q waveform view, [226](#)
    - I/Q polar waveform view, [123](#), [241](#)
    - I/Q waveform graph window, [105](#), [221](#)
    - I/Q Waveform view, [121](#), [239](#)
    - linear envelope and phase view, [120](#), [238](#)
    - Spectrum I/Q Waveform view, [105](#), [221](#)
    - spectrum linear
      - linear spectrum window, [225](#), [226](#)
  - VSA versus PSA series (programming compatibility), [258](#)
- W**
- WAVeform
    - acquisition packing, [494](#)
    - ADC filter, [495](#)
    - ADC range, [495](#)
    - data decimation, [499](#), [500](#)
    - sweep time, [500](#)
    - trigger source, [501](#)
  - waveform
    - changing displays, [241](#)
    - I and Q waveform view, [244](#)
    - I/Q waveform view, [244](#)
    - linear envelope view, [244](#)
    - method, [545](#)
    - resolution bandwidth, [233](#)
    - results, [119](#)
    - span X scale, [241](#)
    - sweep time, [241](#)
    - using markers, [245](#)
  - Waveform (Time Domain) key, [545](#)
  - Waveform (Time Domain) Key Menus, [233](#)
  - waveform (time domain)
    - measurement, [369](#), [494](#)
    - See also WAVeform
  - waveform measurement, [233](#)
    - basic mode, [132](#)
    - display, [245](#)
    - I/Q Polar view, [242](#), [245](#)
    - results, [118](#)
  - Window Length key, [217](#)
- Z**
- zero span measurement, [369](#), [494](#)
  - zoom the display, [313](#)

---

# Index

---